

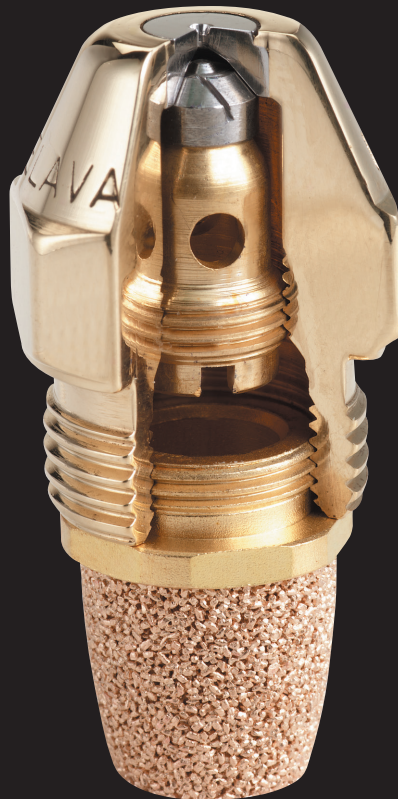

Oil Burner Nozzles and Accessories

for residential and industrial combustion applications



Collins Aerospace

Delavan Precision Oil Burner Nozzles

Delavan has been designing and manufacturing nozzles for the oil heating industry for over 60 years. Quality assurance was important to us way back then and still is today. Since those early days, Delavan has grown and expanded into other markets such as nozzles and accessories for gas turbines, agricultural spray nozzles, industrial spraying, and automotive industry.

Delavan is an established leader in designing and manufacturing nozzles for special industrial combustion applications, and can provide spray solutions that meet the most demanding customer requirements. We specialize in assisting original equipment manufacturers in designing and specifying the best nozzles to fit the unique applications required for emissions and efficiency. Performance development is conducted using a wide array of tools such as spray pattern analysis, particle analysis, and laser imaging to assure our nozzles follow operating parameters for which they are designed.

Delavan nozzles are built according to precise spray controls and to high quality fabrication standards. Delavan nozzles are 100% tested for flow rate, spray angle and spray quality using our proprietary "DelaVision" system that combines digital consistency with the precision of the laser to produce the highest quality, most reliable and consistent nozzles available.

Delavan is a leader in the oil heating industry because we have developed training materials and conducted programs to educate the oil heating service technician. Due to these efforts, our nozzles are the most widely distributed in the US and Canada and also can be found in many global markets.

Whether you are an engineer designing oil burning appliances, a service technician performing annual service, or have a unique application, remember Delavan for assured quality and call on our knowledge and experience whenever you have a nozzle application problem.

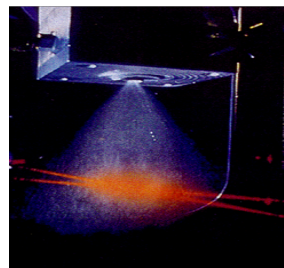
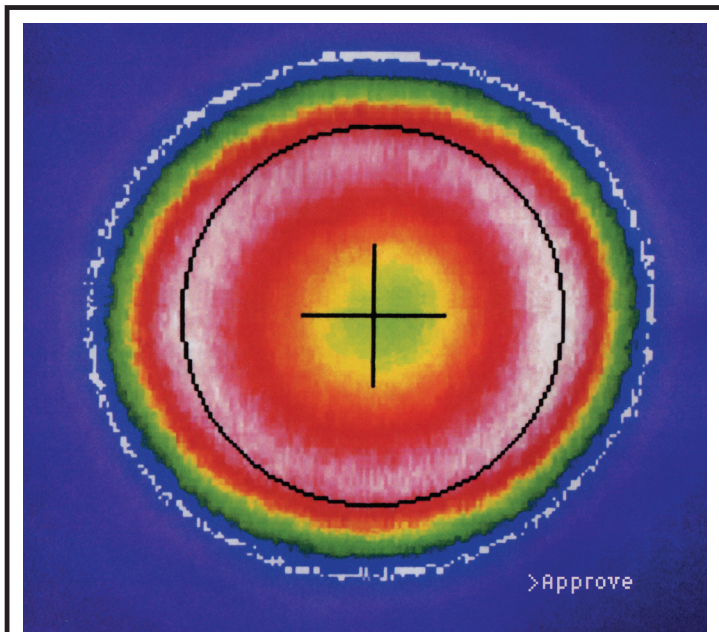

Particle Analysis



Laser Imaging

Spray Pattern Analysis



DELAVAN

4334 Main Highway
Bamberg • South Carolina 29003
www.delavan.com
email: delavansales@collins.com

DELA VISION

Delavan Precision Oil Burner Nozzles

Why is Delavan so different?

- Unique inside anti plug construction

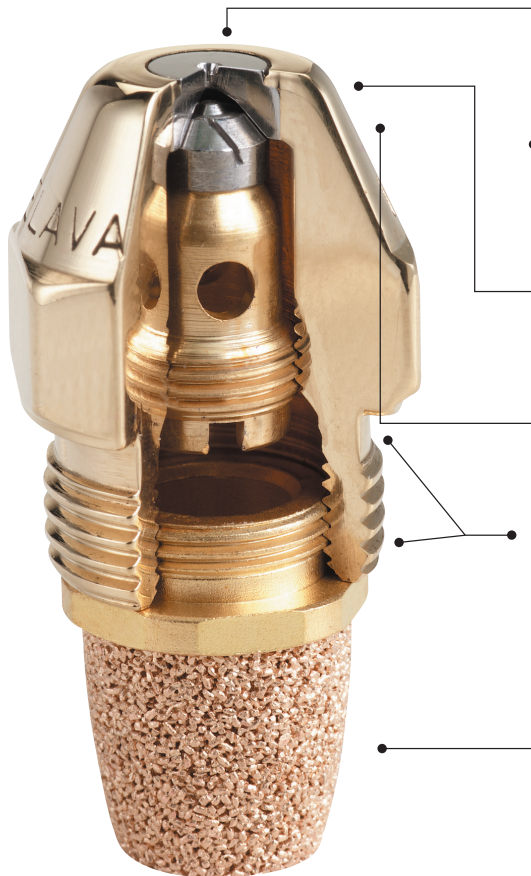

Precise spray angles and optimal spray uniformity through new machining process

Reduced distributor size with shorter tangential slots to avoid plugging

Aerodynamic body configuration

Rolled threads to avoid metal chips and burrs

Sintered filter (*) for maximum protection; sized depending on flow (*)
Mesh strainer supplied on 2.25 GPH and higher flow rates

100% Tested

Every nozzle is tested. Then we go one step further and remove the test oil from the nozzle to avoid plugging.

Meet the challenge

- World leader in spray technology
- State of the art manufacturing equipment
- High technology research, design and quality assurance methods
- ISO 9001 Registered

The world dimension

- Manufacturing with R and D in the USA.
- Manufacturing and marketing facility in the UK.
- Marketing and technical services in France.
- Intercontinental distribution network

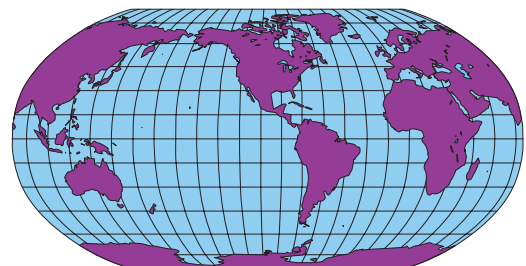

Delavan Precision Oil Burner Nozzles

A VARIETY OF NOZZLES THAT SUITS EVERY APPLICATION

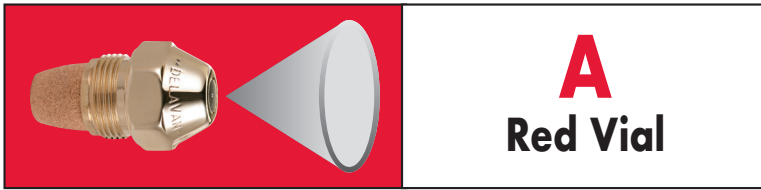

A
Red Vial

HOLLOW-CONE Type A®-nozzles are mainly used on burners with a hollow cone air pattern and for through puts up to 2.00 GPH. The droplet distribution is concentrated on the outside of the cone and results in good ignition and low-noise combustion.

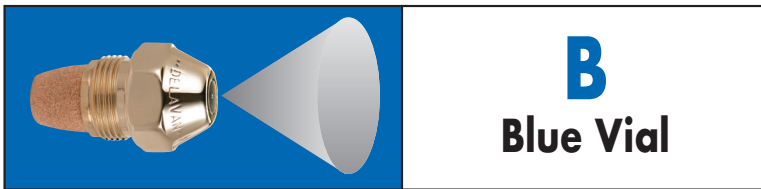

B
Blue Vial

SOLID-CONE Type B®-nozzles produce a spray that distributes droplets fairly uniformly throughout the complete pattern. The spray pattern becomes progressively more hollow at higher flow rates, particularly above 8.00 GPH. Provides smooth ignition and efficient combustion, particularly in larger burners.

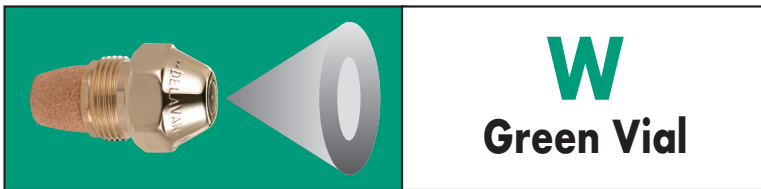

W
Green Vial

Type W "ALL PURPOSE"®-nozzles are neither truly hollow nor solid. These nozzles frequently can be used in place of either solid or hollow cone nozzles between 0.40 and 8.00 GPH, regardless of the burner's air pattern. The lower flow rates tend to be more hollow.

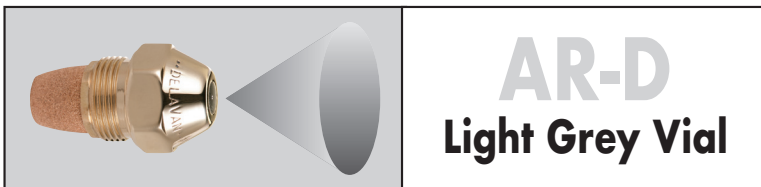

AR-D
Light Grey Vial

Type AR-D Nozzles are of a "solid cone" type similar to Type B but with a slightly lower concentration of the droplets in the center of the cone. They are high performance in burners of low up to medium capacity (up to flows of 2.00 GPH).

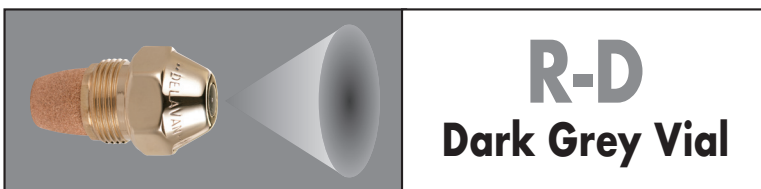

R-D
Dark Grey Vial

Type R-D Nozzles have a high concentration of droplets in the center of the spray cone. They are particularly recommended for burners with a highly concentrated solid air pattern. The average droplet size is slightly coarser than on the Standard Solid Cone Type B (up to flows of 2.00 GPH).



MH
Orange Vial

Type .579 MH Mobile Home Nozzles are low-capacity nozzles designed for mobile home use. This design will minimize the usual plugging problems associated with low flow rates.

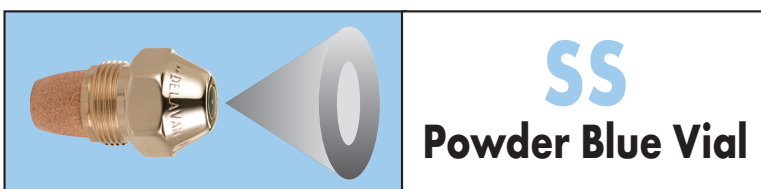

SS
Powder Blue Vial

Semi-Solid nozzle (.50-2.00) 60°, 70° and 80° spray angles; interchanges with other SS nozzles.

Delavan Precision Oil Burner Nozzles

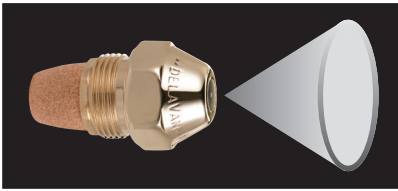

A
Black Vial

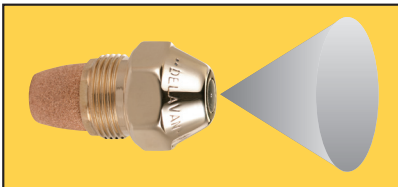

B
Yellow Vial

Del-O-Flo® nozzles are low-capacity nozzles designed to minimize the plugging problems associated with very low flow rates. The special interior design of the Del-O-Flo® flushes contaminants through, limiting build-up. These nozzles will satisfactorily interchange with other hollow and solid cone nozzles. The Del-O-Flo® is available in 0.40 GPH up to 0.85 GPH.

Delavan Uses Technology to Dramatically Reduce Plugging in Low Flow Applications

Low flow appliances represent a growing segment of the oil heating market as manufacturers work to develop more efficient systems. While the future looks good for low flow appliances, the present is rife with headaches for contractors and service personnel. "Particulates in the oil tend to be more of a problem in the low flow applications," says Jeff Stembridge, Delavan Design Engineer. "Because of the reduced flow rates, particulates can easily plug a nozzle either reducing or prohibiting flow." The result can be increased sooting, inefficient operation or a total shut down of the heating system. Some companies have resorted to monthly nozzle changes, increased filtration, or both.



Del-O-Flo® Nozzle Offers an Alternative

Historically, extra filtration has been the only remedy available for low gallonage applications. The Del-O-Flo nozzle reduces plugging with patented technology that forces particulates and other contaminants through and out the nozzle. "The Del-O-Flo contains an extra-fine filter that stops larger particles that cause the problems in low flow situations," says Delavan's Stembridge. "The patented Del-O-Flo design keeps these particles in suspension and forces them out without plugging."

It's All in the Design

With Del-O-Flo Nozzle, fluid flows through the filter into the slots and is metered prior to exiting. The slots are designed to force fluid into a swirling motion where particles are kept in suspension. The nozzle contains short slot openings that are perpendicular to fluid flow. "These short slots keep the fluid from slowing and maintain turbulence, which keeps particulates from collecting, settling, or clogging the nozzle," says Stembridge.

The Del-O-Flo Passes the Test

In a test by Delavan engineers, both a standard hollow cone nozzle and an identical Del-O-Flo hollow cone nozzle were run continuously for 23 hours in a double adapter using the same oil supply. Clean oil was contaminated with a controlled amount of iron oxide (rust) and sand. Both nozzles had filters prohibiting particles over 40 microns so the contaminants utilized were under 40 microns. At the end of the test, the nozzles were disassembled. The photographs below demonstrate the dramatic difference. Contamination buildup on the standard nozzle was substantial while the Del-O-Flo nozzle remained contaminant-free and clean burning.

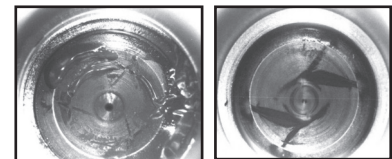

STANDARD
HOLLOW CONE

DELAVAN
DEL-O-FLO®

Under identical test situations the standard nozzle produced contamination build up which causes plugging, while the Del-O-Flo remained contaminant-free.

Delavan Precision Oil Burner Nozzles

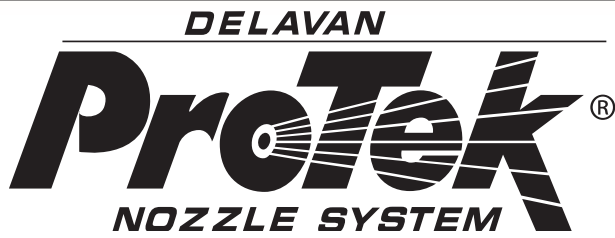

**SMART VALVE
DESIGN REDUCES
COMBUSTION
POLLUTION FOR
CLEANER HEATING**



The all-new Delavan ProTek® Nozzle System provides the first step into the future of Clean Air Technology®. This unique, patented System from Delavan provides significant reductions in combustion pollutants for cleaner air. The ProTek Nozzle System includes a factory-installed, one-piece Valve Component which reduces smoke and oil smell in the off cycle by preventing oil after-drip from the nozzle. Also, the reduction of smoke (carbon and soot) helps maintain burner set up efficiency longer and extend the time period between appliance clean ups.

Installation is fast and easy; there's no need to increase pump supply pressure at installation because there's no pressure drop. Plus, ProTek Nozzle Systems maintain the same flow pattern and flow rating characteristics of comparably rated Delavan nozzles.

The dramatic benefits of the ProTek Nozzle System are available in either a factory-installed, complete system or as the ProTek Valve Component sold separately to replace the standard filter on a Delavan nozzle.

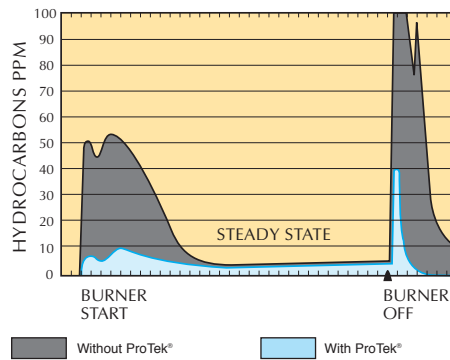

Hydrocarbon emissions are greatly reduced when the Delavan ProTek® Nozzle System is used. Hydrocarbons are typically elevated at start-up and shut-down of the nozzle firing, as both of these graphs show. When the ProTek Nozzle System is installed, the dramatic benefits are seen in these charts which show comparative results with and without the ProTek® valve. Results will vary by application.

TEK TALK

The Delavan ProTek® Nozzle System has been thoroughly tested. In the tests, approximately seven years of "on/off" cycle operation simulation in the laboratory with no failures. A total of 107,000 cycles were recorded. After the first 11,350 cycles, the cut-on pressures shifted upward an average of 3.0 PSI. The cut off pressure shifted up an average of 7.75 PSI. After this initial seating process, there was very little change of either "on" or "off" pressures. Very little change in nozzle flow was noted after 107,000 cycles, either. Additional testing has included pressure tests up to 500 PSI (34,5 BAR), as well as combustion tests and tests with various fuels such as kerosene, #2, and heavier oils. Detailed test results are available from Delavan Technical Services.

Operating Pressures

Valve Part #	Minimum Operating Pressures		
	Supply Pump PSI (BAR)	Valve Open PSI (BAR)	Valve Close PSI (BAR)
60030-001	135.0 (9,3)	125.0 (8,6)	65.0 (4,5)
60030-002	100.0 (7,0)	60.0 (4,1)	45.0 (3,1)

Delavan Precision Oil Burner Nozzles

Oil Burner Nozzles For Residential Applications AVAILABLE NOZZLE SIZES

Types A and B						
GPH	30°	45°	60°	70°	80°	90°
.40	Yellow	Green				
.50	Yellow	Green				
.55	Yellow	Green				
.60	Yellow	Green				
.65	Yellow	Green				
.70	Yellow	Green				
.75	Yellow	Green				
.80	Yellow	Green				
.85	Yellow	Green				
.90	Yellow	Green				
1.00	Yellow	Green				
1.10	Yellow	Green				
1.20	Yellow	Green				
1.25	Yellow	Green				
1.35	Yellow	Green				
1.50	Yellow	Green				
1.65	Yellow	Green				
1.75	Yellow	Green				
2.00	Yellow	Green				
2.25	Yellow	Green				
2.50	Yellow	Green				
2.75	Yellow	Green				
3.00	Yellow	Green				
3.25	Yellow	Green				
3.50	Yellow	Green				
3.75	Yellow	Green				
4.00	Yellow	Green				
4.50	Yellow	Green				
5.00	Yellow	Green				
5.50	Yellow	Green				
6.00	Yellow	Green				
6.50	Yellow	Green				
7.00	Yellow	Green				
7.50	Yellow	Green				
8.00	Yellow	Green				
8.50	Yellow	Green	Green	Green	Green	Green
9.00	Yellow	Green	Green	Green	Green	Green
10.00	Yellow	Green	Green	Green	Green	Green
11.00	Yellow	Green	Green	Green	Green	Green
12.00	Yellow	Green	Green	Green	Green	Green
13.00	Yellow	Green	Green	Green	Green	Green
14.00	Yellow	Green	Green	Green	Green	Green
15.00	Yellow	Green	Green	Green	Green	Green
16.00	Yellow	Green	Green	Green	Green	Green
17.00	Yellow	Green	Green	Green	Green	Green
18.00	Yellow	Green	Green	Green	Green	Green
19.00	Yellow	Green	Green	Green	Green	Green
20.00	Yellow					
22.00	Yellow					
24.00	Yellow					
26.00	Yellow					
28.00	Yellow					
30.00	Yellow					
32.00	Yellow					
35.00	Yellow					
40.00	Yellow					
45.00	Yellow					
50.00	Yellow					

Type W						
GPH	30°	45°	60°	70°	80°	90°
.40	Red	Green				
.50	Yellow	Green				
.55	Yellow	Green				
.60	Yellow	Green				
.65	Yellow	Green				
.70	Yellow	Green				
.75	Yellow	Green				
.80	Yellow	Green				
.85	Yellow	Green				
.90	Yellow	Green				
1.00	Yellow	Green				
1.10	Yellow	Green				
1.20	Yellow	Green				
1.25	Yellow	Green				
1.35	Yellow	Green				
1.50	Yellow	Green				
1.65	Yellow	Green				
1.75	Yellow	Green				
2.00	Yellow	Green				
2.50	Yellow	Green				
2.75	Yellow	Green				
3.00	Yellow	Green				
3.25	Yellow	Green				
3.50	Yellow	Green				
3.75	Yellow	Green				
4.00	Yellow	Green				
4.50	Yellow	Green				
5.00	Yellow	Green				
5.50	Yellow	Green				
6.00	Yellow	Green				
6.50	Yellow	Green				
7.00	Yellow	Green				
7.50	Yellow	Green				
8.00	Yellow	Green				

.579 MH Mobile Home Nozzle	
Green	Normally Stocked
Yellow	Limited Inventory
Red	Special Order
Red	Not Available

Del-O-Flo Type A and B					
GPH	45°	60°	70°	80°	90°
.40	Green				Red
.50	Green				
.55	Green				
.60	Green				
.65	Green				
.75	Green				
.80	Green				
.85	Green				

Type SS			
GPH	60°	70°	80°
.50	Green		
.60	Green		
.65	Green		
.75	Green		
.85	Green		
1.00	Green		
1.10	Green		
1.20	Green		
1.25	Green		
1.35	Green		
1.50	Green		
1.65	Green		
1.75	Green		
1.75	Green		
2.00	Green		

Types R-D and AR-D				
GPH	45°	60°	70°	80°
.50	Green	Green	Green	Green
.60	Green	Green	Green	Green
.65	Green	Green	Green	Green
.75	Green	Green	Green	Green
.85	Green	Green	Green	Green
1.00	Green	Green	Green	Green
1.10	Green	Green	Green	Green
1.20	Green	Green	Green	Green
1.25	Green	Green	Green	Green
1.35	Green	Green	Green	Green
1.50	Green	Green	Green	Green
1.65	Green	Green	Green	Green
1.75	Green	Green	Green	Green
1.75	Green	Green	Green	Green
2.00	Green	Green	Green	Green

Delavan Precision Oil Burner Nozzles

NOZZLE INTERCHANGE

Replacing a nozzle of one make with another sometimes presents problems. This is partly due to unique design differences among the various makes, plus the fact that the nozzle manufacturers use different methods for evaluating spray angles, patterns and spray quality.

In many cases, nozzles with similar patterns and spray angles are directly interchangeable. However, there are other cases where nozzles that would seem to be equivalent really are not. When this happens it is best to ask the burner manufacturer for a recommendation. Otherwise, it is a matter of trial and error: (1) Trying nozzles with slightly higher or lower flow rates, (2) wider or narrower angles and (3) more solid or more hollow patterns, to see which one performs best.

Nozzle Interchange Chart	
<i>Spray Angles 30° through 90°</i>	
HAGO	DELANV
H	A
SS (up to 2.0)	SS
SS (over 2.0)	A or W
ES/P	B*
B	B*
MONARCH	DELANV
NS/PL	A
R/AR (up to 2.0)	R-D/AR-D
R/AR (over 2.0)	A/A or W
PLP	B*
DANFOSS	DELANV
AS	W or B
AH	A

*The original B Nozzle

WARNING: Improper modification to combustion units may create a fire hazard resulting in possible injury. Contact the original equipment manufacturer before modifying the combustion unit.

P.O. Box 969 • Bamberg, SC 29003
www.delavan.com

1-800-982-6943

NOZZLE RATINGS AND TESTING

Every nozzle is spray tested for flow rate, spray angle and spray quality. Our nozzles are flow rated at 100 psi. Test conditions include: fuel gravity within a total spread of 1-1/20 API . . . viscosity within ± .04 centistoke (.03 SSU) . . . pressure at 100 psi . . . fuel temperature at 80°F, ± 2°F . . . an air-conditioned test area maintained at a temperature spread of 40F or less . . . and regularly calibrated pressure gauges and flow meters.

NOZZLE DIMENSIONS

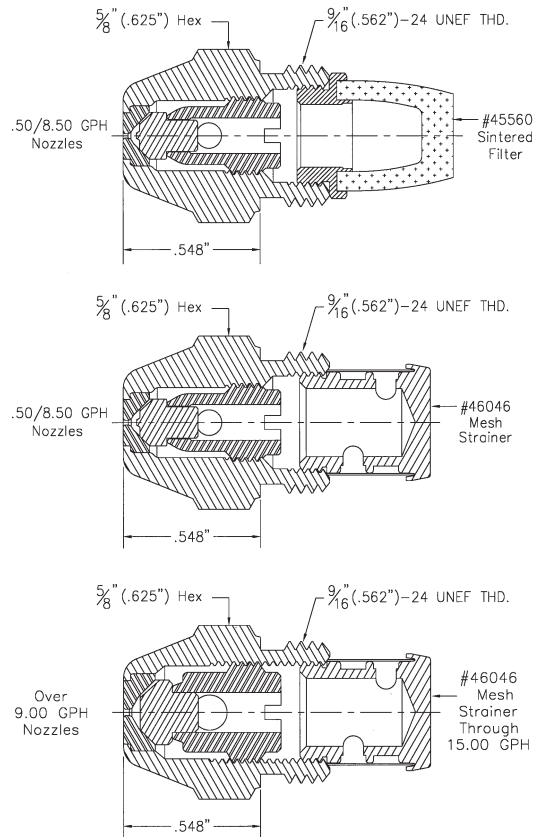

ORDERING INSTRUCTIONS

WHEN ORDERING OIL BURNER NOZZLES, be sure to specify the following:

- (1) Quantity
- (2) Capacity rating in gallons per hour (gph)
- (3) Spray angle
- (4) Spray pattern or type:
Hollow cone--Type A, Del-O-Flo Type A
Solid cone--Type B, Del-O-Flo Type B, Type W
- (5) Filter or strainer--See selection chart on page 7 for sintered filters and mesh strainers furnished with each nozzle. Optional mesh sizes may be substituted when ordering nozzles. Order by part number and description.

WHEN ORDERING ACCESSORIES, be sure to specify part number and brief description.

Delavan Spray, LLC.
P.O. Box 969 • Bamberg • South Carolina 29003

Refer to each product section for specific instructions on information to include when ordering. Contact your Delavan representative or the factory for the current price list and for any assistance in finding the right nozzle for your application.

Delavan Precision Oil Burner Nozzles



LINE FILTER

Use Delavan's line filter for extra filtration in burner applications of 2.00 GPH or less. These offer four times the filtering area of a standard nozzle strainer and twice the protection. A plugged line filter can cause a pressure drop. Check the pressure on the outlet side of the filter while the unit is flowing to see that it is the same as the pump pressure. If less, replace filter.

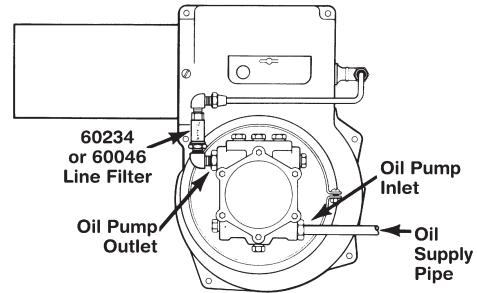

- 60046 1/8" NPT inlet and outlet threads
- 60234 1/8" SAE 45° Flare inlet and outlet threads

Easy installation (see drawing)

NOTE: Replace the line filter during the annual service check for an economical way to maintain clear lines.



SINTERED FILTERS & STRAINERS

Nozzles up to 2.00 GPH have as standard a sintered filter. From 2.25 up to 15.00, monel filters are provided. Nozzles with through-put of 16.00 GPH and higher have no filter attached.

Type	Part #	Media/Mesh size
Sintered Filter	45560-004	25 Micron
Sintered Filter	45560-001	40 Micron
Mesh Strainer	46046-001	74 micron/200M
Mesh Strainer	46046-002	125 Micron/120M

It is recommended to use sintered filters on nozzles with low throughput.

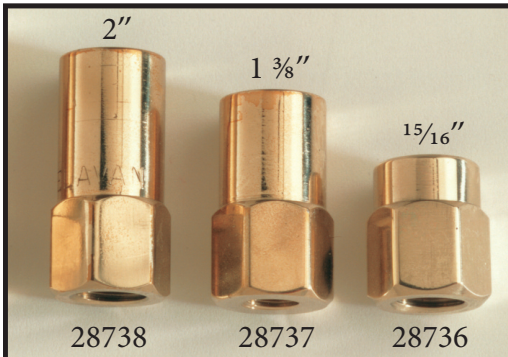

NOZZLE ADAPTERS

All nozzle adapters are made of brass, with precision machined mating surfaces for proper sealing.

IMPORTANT specify 1/8" or 1/4" pipe thread size

All nozzle adapters 9/16-24 UNEF internal thread

	Thd Size	Part Number
Long (Female)	1/8"	28738-001
	1/4"	28738-003
Standard (Female)	1/8"	28737-001
	1/4"	28737-003
Short (Female)	1/8"	28736-001
	1/4"	28736-003
Male	3/8"	28741-001

NOTE: Nozzle adapters are available in stainless steel. Contact customer service or your sales representative for more information.



DISPLAY STORAGE RACKS

An attractive black plastic display and storage rack is available and will hold up 120 nozzles (12 vials in 10 slots). It is inexpensive, light-weight and easy to mount on the wall. Holes are drilled in the rack for easy mounting. This rack is packaged two to a carton; order in multiples of two.

Part number #47749

Delavan Precision Oil Burner Nozzles

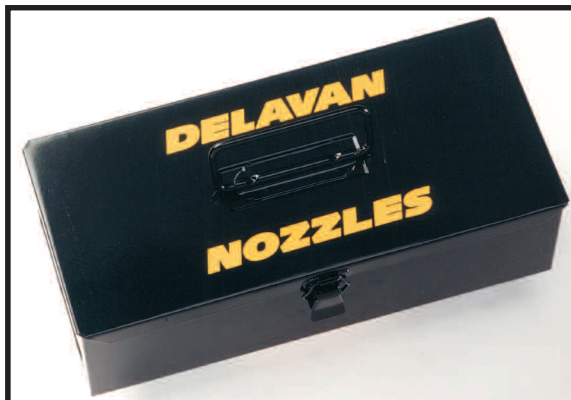

NOZZLE BOXES

Delavan nozzle boxes handle all brands of nozzle vials. Our 110-nozzle and 55-nozzle boxes are made up of heavy-gauge steel with rugged hinges and snap-latch construction... finished in baked-on jet black enamel.

#26846-4 -- 110 Nozzle Box -- (5" x 3 5/8" x 11 15/16")

*Visit our website at
www.delavan.com
for more details about
our products and
services.*



#26846-5 -- 55 Nozzle Box --
(5" x 1 3/4" x 11 15/16")

The W™ nozzle. Fast becoming the first choice of major OEMs worldwide.

Other nozzles can only wish they could be as versatile, as functional and as "in demand" as the Delavan W™ nozzle. The W is quickly becoming the most popular nozzle on Original Equipment Burners. It's also the nozzle more Service Managers recommend to reduce smoking and CO formation on problem burners. It's the quiet, efficient, "all purpose" nozzle that is equally at home in small residential burners and larger commercial units or boilers.

The Delavan W, in the green vial, has a more hollow pattern at the lower gallonage ranges, which is ideal for the residential warm air home heating furnaces that require a short, bushy fire. As the gallonage size moves up on the W, it becomes more of a solid pattern which is ideal with larger units with a longer firing chamber or a boiler.

So, next time you need a truly all purpose nozzle, go green.

DELAVAN 

For more information: PO Box 969 | Bamberg, SC 29003 | 800.982.6943 | FAX 803.245.4146 | delavansales@utas.utc.com | www.delavaninc.com

Delavan Precision Oil Burner Nozzles

Type WDA & WDB

Pressure Atomizing Nozzles for humidifying

Spray Characteristics

- Finely atomized cone spray pattern for humidifying
- WDA has a hollow cone pattern
- WDB has a solid cone pattern
- Available spray angles - 30 , 45 , 60 , 70 , 80 and 90

Ordering Instructions

WHEN ORDERING TYPE WDA & WDB NOZZLES, be sure to specify the following :

- 1) Nozzle number per capacity chart
 - 2) Spray angle
 - 3) Material (brass with stainless steel metering parts will be furnished if material is not specified).
- Order adapters separately, see selection chart.

Materials

Nozzle bodies are available in brass or stainless steel with a stainless steel orifice disc. Distributors are stainless steel and retainers are available in brass or stainless steel. Strainers are furnished up through WDA/WDB15 (15.0 GPH @ 125 PSIG) with each nozzle.

Adapter Selection Chart

Pipe Size	Adapter P/N		Length	
	Brass	S.S.	Adapter only	Adapter plus nozzle
1/8 NPTF	28737-001	28737-002	1.375"	1.905"
1/4 NPTF	28737-003	28737-004	1.375"	1.905"
3/8 NPTM	28741-001	—	1.375"	1.905"

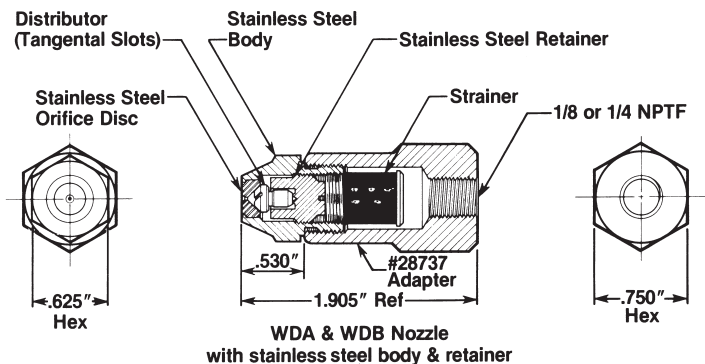

WDA & WDB Nozzle with stainless steel body & retainer

WDA-WDB CAPACITY CHART

NOZZLE NO. = CAPACITY AT 125 PSIG

NOZZLE NUMBER			App. Orif. Dia.	CAPACITY — GPH AT PSIG PRESSURE — based on water							
WDA	WDB	No.		30 PSIG	40 PSIG	75 PSIG	100 PSIG	125 PSIG	150 PSIG	300 PSIG	500 PSIG
WDA	WDB	*.50	.0083	—	—	.39	.45	.50	.55	.77	1.0
WDA	WDB	*.75	.0092	—	—	.58	.67	.75	.82	1.16	1.5
WDA	WDB	1.0	.011	—	—	.77	.89	1.00	1.10	1.55	2.0
WDA	WDB	1.5	.013	—	—	1.16	1.34	1.50	1.65	2.32	3.0
WDA	WDB	2.0	.015	—	—	1.55	1.79	2.00	2.20	3.10	4.0
WDA	WDB	2.5	.016	—	—	1.93	2.24	2.50	2.74	3.88	5.0
WDA	WDB	3.0	.018	—	—	2.32	2.68	3.00	3.30	4.65	6.0
WDA	WDB	4.0	.025	—	2.2	3.1	3.6	4.0	4.4	6.2	8.0
WDA	WDB	5.0	.025	—	2.8	3.9	4.5	5.0	5.5	7.7	10.0
WDA	WDB	6.0	.029	—	3.6	4.7	5.4	6.0	6.6	9.3	12.0
WDA	WDB	8.0	.032	—	4.5	6.2	7.2	8.0	8.9	12.4	16.0
WDA	WDB	10.0	.035	4.8	5.6	7.7	8.9	10.0	11.0	15.5	20.0
WDA	WDB	12.0	.040	5.8	6.8	9.3	10.7	12.0	13.2	18.6	24.0
WDA	WDB	14.0	.040	6.8	7.9	10.8	12.5	14.0	15.3	21.7	28.0
WDA	WDB	16.0	.046	7.8	9.0	12.4	14.3	16.0	17.5	24.8	32.0
WDA	WDB	18.0	.052	8.8	10.1	13.9	16.1	18.0	19.7	27.9	36.0
WDA	WDB	20.0	.055	9.8	11.3	15.5	17.9	20.0	21.9	31.0	40.0
WDA	WDB	24.0	.060	12.3	13.5	18.6	21.5	24.0	26.3	37.2	48.0
WDA	WDB	30.0	.067	14.6	16.9	23.2	26.8	30.0	32.9	46.5	60.0
WDA	WDB	35.0	.070	17.2	19.8	27.2	31.4	35.0	38.4	54.3	70.0

*NOT AVAILABLE IN 30° WDA-WDB Nozzles above 16.0 GPH are furnished without strainers. Max. Design Pressure: 500 psig

Delavan Oil Burner Nozzles For Industrial Applications

For Industrial and Special Combustion Applications

Delavan, as a world leader in nozzle technology, offers a unique variety of products to meet the requirements of domestic and industrial combustion.

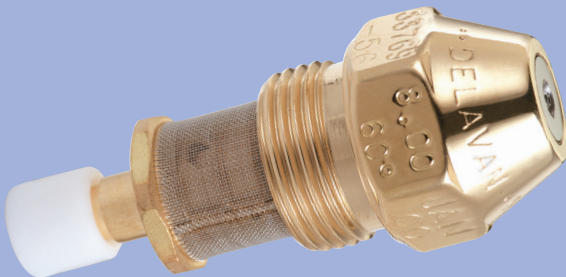

VARIFLO® - RETURN FLOW NOZZLES

Pressure atomizing nozzles for good atomization over a wide flow range.

- Permits variable burner outputs based on by-pass pressure
- Wider spray angles at lower flow rates
- Less subject to clogging

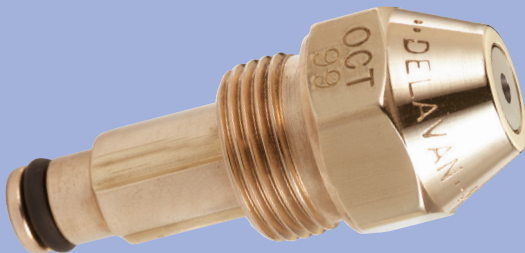

SNA-SIPHON® TYPE AIR ATOMIZING NOZZLES

for extremely fine spray particle size at low air pressures

- Permits good combustion with medium and heavy oils
- Produces a solid cone spray with extremely fine particle size at low air pressures
- Clog free operation of low volume due to large inside passages and orifice

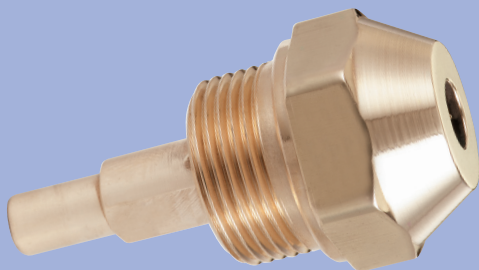

AIRO® - AIR ATOMIZING NOZZLES

For good atomization of both light and heavy oils at higher flow rates.

Covers a wide range of throughputs from 10.00 GPH (32 kg./h up to 200.00 GPH (720 kg./h)

VARIFLO® Pressure Atomizing Nozzles

for good atomizing over
a wide flow range

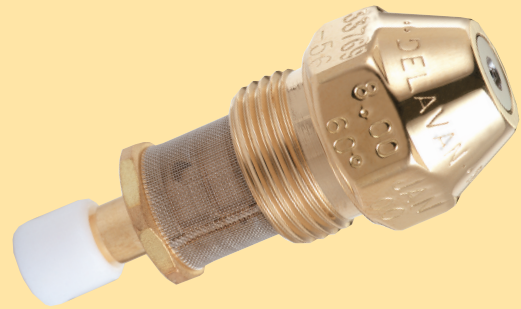

SPRAY CHARACTERISTICS

- Good atomization over a wider flow range.
- Wider spray angles at lower flow rates.
- Less subject to clogging.
- Less buildup of carbon and gum residue

HOW IT WORKS

The Delavan Variflo nozzle is a pressure atomizing nozzle which provides discharge rate variations without changing nozzles. This is accomplished by the bypass principle.

With constant inlet supply pressure and the bypass (return line) closed, the nozzle operates as a simplex atomizing nozzle. For a reduced discharge flow the bypass line is opened and part of the fuel is allowed to return to the tank. The advantage is reduced flow without deterioration of the spray quality.

The maximum to minimum discharge flow rate at constant supply pressure is referred to as the "turndown ratio". The standard catalog nozzles have turndown ratios of approximately 5 to 1.

The key advantage of the Variflo over a simplex nozzle (like Delavan's oil burner nozzles) is flexibility; larger turndown ratios with better atomization. With the Variflo nozzle, using a constant supply pressure, the discharge flow rate varies approximately as the square of the bypass pressure. This means that at minimum flows the atomization pressure is reduced approximately 34 percent. With the simplex nozzle the discharge flow rate varies as the square root of the supply pressure. This means that to obtain one-half of the design flow rate the supply pressure must be reduced by 1/4 of the original pressure. This pressure is too low for good atomization.

INSTALLATION

The Delavan Variflo nozzle may be:

1. Operated at a fixed discharge rate. The rates may be set by a valve to any flow rate in the nozzle's range.

2. Adapted for 2-stage firing. This is helpful when a low-fire start is required.
3. Operated with complete modulation over the designed flow range (with proper equipment).

The fuel supply system for the Variflo nozzle is the same inlet pump and pressure control system as for a simplex nozzle. The only difference is that pump capacity must be at least 50 percent over the rated (maximum) flow rate of the nozzle.

For a **FIXED FIRING RATE**, with manual adjustment when required, hook up as shown in figure 1. Use a relief valve for the bypass system control.

For **2-STAGE FIRING**, the hookup is the same except a solenoid valve is added. (See inset, figure 1.) The bypass control valve in this hookup should be set for minimum flow with the solenoid normally open for low fire. High fire is obtained by closing the solenoid. The solenoid may be actuated by a timer or temperature or pressure sensing element.

For **COMPLETE MODULATION**, hook up as shown in figure 1 except use a modulating valve by temperature or pressure, through the proper modulating motor, linked to the combustion air supply.

Remove pressure gauges from the system after making adjustments. The pressure gauge provides an air cushion in the system which causes after-squirt and drooling.

Return the bypass line to the supply tank as shown in figure 1. The Variflo nozzle can, under some conditions, draw air into the bypass line through the discharge orifice even during operation. If the air were piped to the suction side of the pump, the pump could become air locked with a resulting pressure loss. Another advantage to returning the line to the tank is extended nozzle life because the nozzle will run cooler.

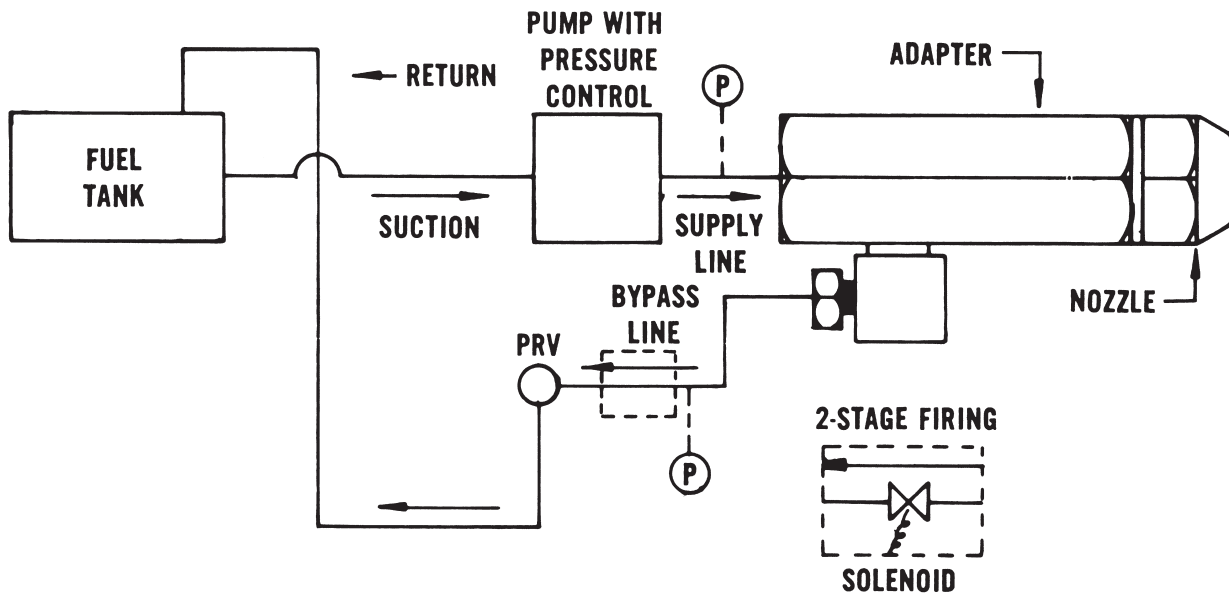
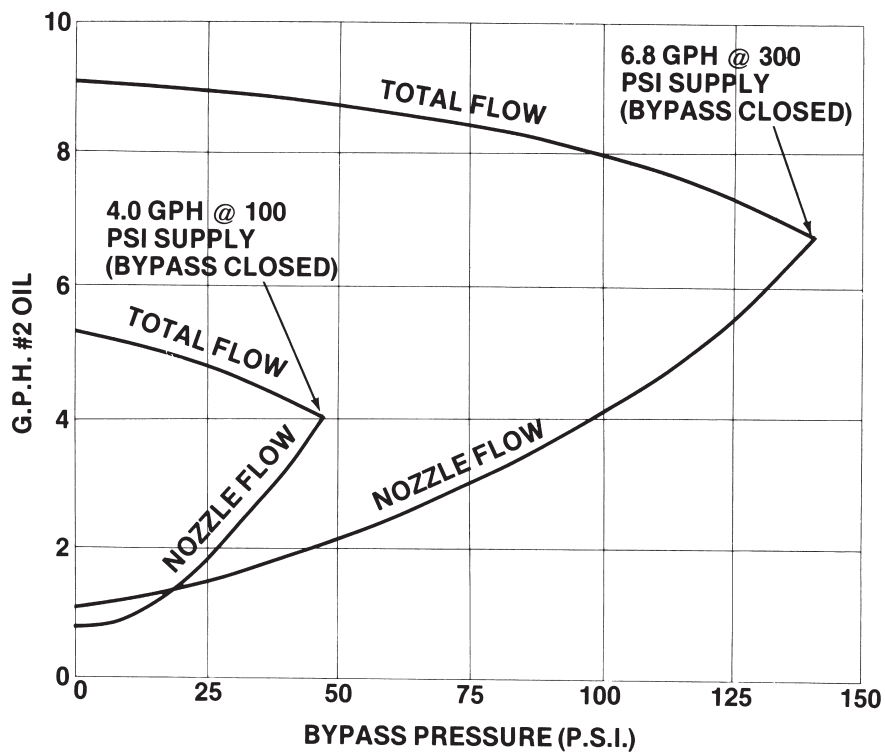
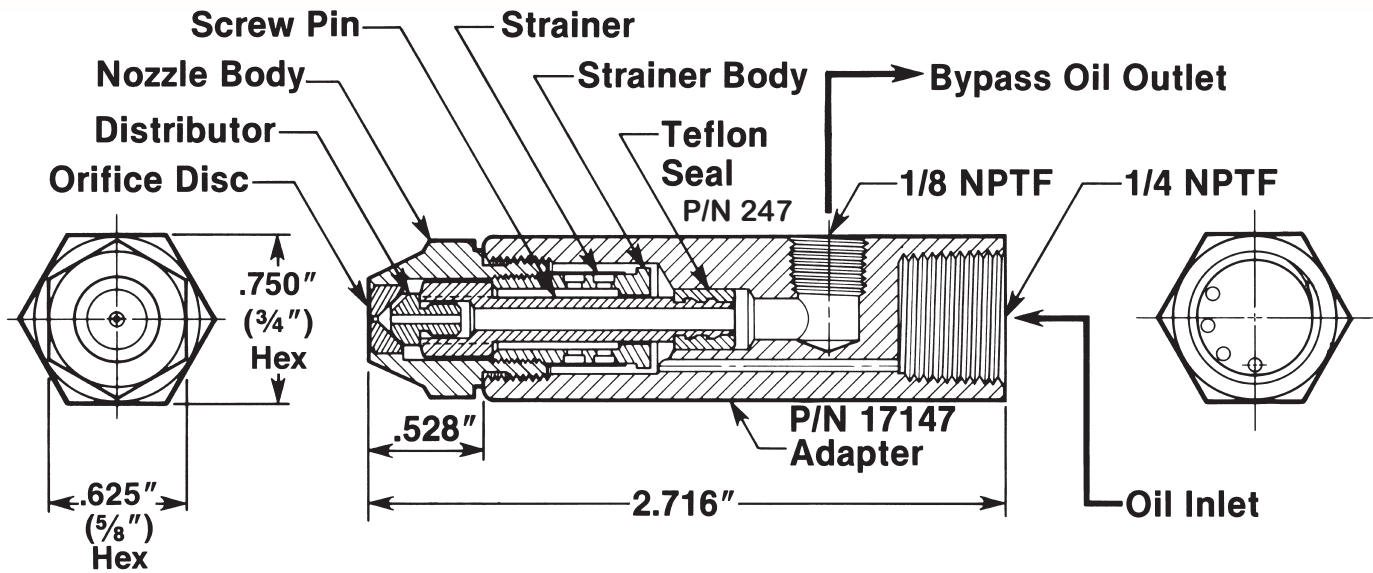

FIGURE 1. INSTALLATION SCHEMATIC



TYPICAL CURVE @ 100 & 300 PSI SUPPLY
(5 to 1 turn down — 5/8" hex size)



Variflo Nozzle Assembly P/N 33769

(see chart for dash no. corresponding to flow & spray angle desired)
VARIFLO NOZZLE CAPACITY CHART

Dash No.	Spray Angle	Bypass Closed Calibrated Nozzle Flow-GPH	100 PSI Supply		300 PSI Supply
			Bypass Open		Bypass Closed
			Total Flow -GPH (Ref.)	Nozzle Flow -GPH (Ref.)	Nozzle Flow -GPH (Ref.)
-001 -002	45° 60°	.75	1.02	.20	1.27
-003 -004	45° 60°	1.00	1.30	.22	1.60
-005 -006 -007	45° 60° 80°	1.50	1.90	.30	2.30
-008 -009 -010	45° 60° 80°	2.00	2.60	.38	3.30
-011 -012 -013	45° 60° 80°	2.50	3.40	.49	4.00
-014 -015 -016 -017	30° 45° 60° 80°	3.00	4.00	.57	5.00
-018 -019 -020 -021	30° 45° 60° 80°	3.50	4.60	.67	6.00
-022 -023 -024 -025	30° 45° 60° 80°	4.00	5.20	.78	6.80
-026 -027 -028 -029	30° 45° 60° 80°	4.50	6.00	.85	7.50
-030 -031 -032 -033	30° 45° 60° 80°	5.00	6.6	.97	8.60
-034 -035 -036 -037	30° 45° 60° 80°	5.50	7.40	1.02	9.10
-038 -039 -040 -041	30° 45° 60° 80°	6.00	8.00	1.17	9.90

Dash No.	Spray Angle	Bypass Closed Calibrated Nozzle Flow-GPH	100 PSI Supply		300 PSI Supply
			Bypass Open		Bypass Closed
			Total Flow -GPH (Ref.)	Nozzle Flow -GPH (Ref.)	Nozzle Flow -GPH (Ref.)
-042 -043 -044 -045	30° 45° 60° 80°	6.50	8.50	1.25	10.75
-046 -047 -048 -049	30° 45° 60° 80°	7.00	8.90	1.35	11.80
-050 -051 -052 -053	30° 45° 60° 80°	7.50	9.90	1.41	12.50
-054 -055 -056 -057	30° 45° 60° 80°	8.00	10.60	1.56	13.5
-058 -059 -060 -061	30° 45° 60° 80°	9.00	11.50	1.72	15.00
-062 -063 -064 -065	30° 45° 60° 80°	9.50	12.80	1.78	15.90
-066 -067 -068 -069	30° 45° 60° 80°	10.00	13.40	1.92	16.70
-070 -071 -072 -073	30° 45° 60° 80°	12.00	15.90	2.26	20.80
-074 -075 -076 -077	30° 45° 60° 80°	14.00	19.00	2.75	23.50
-078 -079 -080	45° 60° 80°	16.00	21.00	3.10	27.00
-081 -082 -083	45° 60° 80°	18.00	24.00	3.40	31.20
-084 -085 -086	45° 60° 80°	20.00	26.50	3.70	33.80
-087 -088 -089	45° 60° 80°	22.00	28.70	4.10	36.80
-090 -091 -092	45° 60° 80°	24.00	31.50	4.65	41.00
-093 -094 -095	60° 80° 90°	28.00	36.00	5.22	48.50
-096 -097 -098	60° 80° 90°	30.00	38.50	5.80	51.50
-099 -100 -101	60° 80° 90°	35.00	46.40	6.70	59.60
-102 -103	60° 80°	40.00	50.00	10.70	68.00
-104 -105	60° 80°	45.00	58.00	9.70	75.50
-106 -107	60° 80°	50.00	62.00	13.90	84.50

NOTE: 30° & 90° nozzles listed above available on special order only.

Other flow rates and spray angles available on special order.

Nozzles are calibrated for flow and spray angle at 100 PSI on #2 oil. Spray angles at 300 PSI will be somewhat narrower than spray angle at 100 PSI. As bypass is opened, spray angle will increase (up to 15° wider) both at 100 PSI and 300 PSI supply.

ORDERING INSTRUCTIONS

WHEN ORDERING VARIFLO NOZZLES, be sure to include both part number and description. Specify P/N 33769 – (see nozzle capacity chart for dash number corresponding to flow and spray angle desired). Order adapter separately (specify P/N 17147).

Dimensions and Adapter Information

Nozzle Body Size	Dimensions (Inches)			Adapter P/N	Adapter Threads Npt		Seal P/N
	Overall Length	Adapter Hex	Seal Surface to Nozzle Face	(Includes Seal)	Return Port	Supply Inlet	(Teflon)
5/8" Hex	2.72	0.75	0.528	17147 Brass	1/8	1/4	247
13/16" Hex	2.81	0.813	0.620	30298 Brass	1/8	1/4	337
1-1/4" Hex	3.67	1.25	0.800	31437 Mild Steel	1/4	3/8	1733

13/16" Variflo Nozzle Assembly

P/N 30630 Standard brass body with stainless steel metering set, 4 to 1 turndown ratio.

P/N 30631 Brass body with hardened stainless steel metering set, 4 to 1 turndown ratio.

Max Capacity in GPH			Standard Spray Angle at Maximum Flows (widens slightly at lower flows)						
@150 PSI Inlet pressure Using #2 fuel oil	@300 PSI Inlet pressure Using #2 fuel oil Rated Flow	@300 PSI using #5 Fuel Oil preheated to 100 SSU	30°	45°	60°	70°	80°	90°	
14.2	20	Approx same as for #2 fuel oil	-1	-2	-3	-4	-5	-6	
17.7	25		-7	-8	-9	-10	-11	-12	
21.2	30		-13	-14	-15	-16	-17	-18	
Recommended 300 PSI Next Column	35				-19	-20	-21	-22	-23
	37.5				-51	-52	-53	-54	-55
	40				-24	-25	-26	-27	-28
	45				-29	-30	-31	-32	-33
	50				-34	-35	-36	-37	-38
	55					-56	-57	-58	-59
	60					-39	-40	-41	-42
	65					-60	-61	-62	-63
70					-43	-44	-45	-46	
80				-47	-48	-49	-50		

1-1/4" Variflo Nozzle Assembly

P/N 30637 Standard stainless steel, 4 to 1 turndown ratio.

P/N 30649 All stainless steel with threaded scerw pin,, 4 to 1 turndown ratio.

P/N 30689 All stainless steel with hardened metering set, 4 to 1 turndown ratio.

@150 PSI Inlet pressure Using #2 fuel oil	@300 PSI Inlet pressure Using #2 fuel oil Rated Flow	@300 PSI using #5 Fuel Oil preheated to 100 SSU	Standard Spray Angle at Maximum Flows (widens slightly at lower flows)			
			60°	70°	80°	90°
Recommended 300 PSI Next Column	80	Approx same as for #2 fuel oil	-1	-2	-3	-4
	90		-5	-6	-7	-8
	100		-9	-10-	-11	-12
	125		-13	-14	-15	-16
	150		-17	-18	-19	-20
	165					

Contact customer service or your sales representative for more information.

SIPHON TYPE SNA[®] Air Atomizing Nozzles

for extremely fine spray
particle size at low air pressures

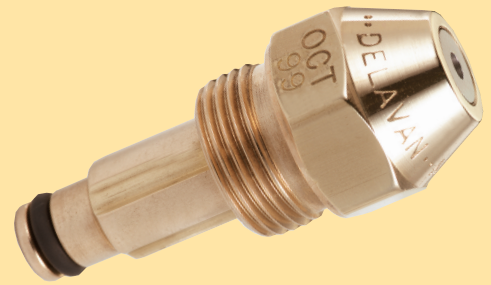

SPRAY CHARACTERISTICS

- Produces a solid cone spray pattern with extremely fine particle size at low air pressures and low CFM.
- Flow rates, spray angles and droplet sizes can be modified, with limitations, by variations in air, lift, etc.
- Clog free operation of low volume due to relatively large passages.

INSTALLATION

The air compressor should be capable of providing at least 10% more air than the specified values. All fuel and air line connections must be tight. Any leaks, especially in the fuel line, will have an adverse effect on the lift characteristics.

The nozzle will flow in either a horizontal or vertical position. The lift distance for a vertical mounted nozzle is measured from the liquid level to the end (face) of the nozzle. The lift distance for the horizontal mounting is shown in the installation drawing.

If the combustion application does not permit the use of a constant level device, excellent spray characteristics can be obtained using a fuel metering pump and an air compressor. It is also possible to operate the nozzle in a closed pressurized system utilizing air pressure for both lifting and atomizing the fuel.

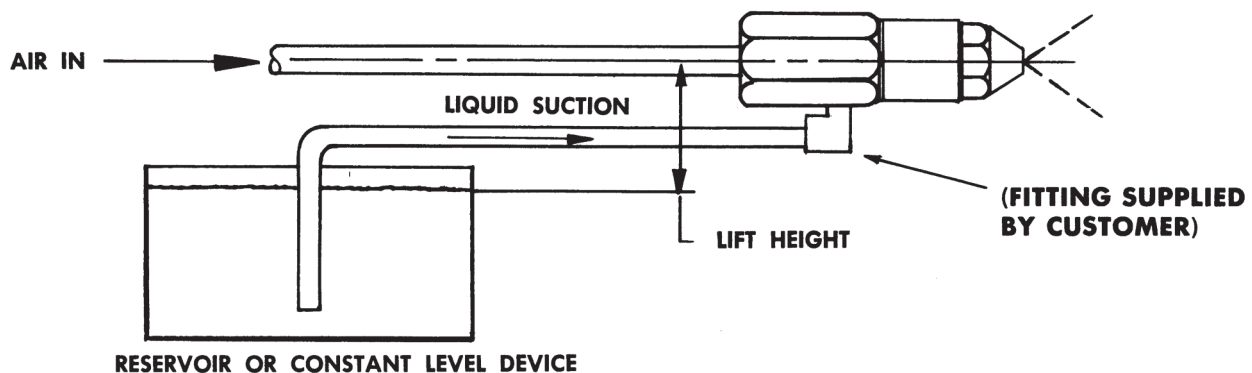

Delavan Precision Oil Burner Nozzles

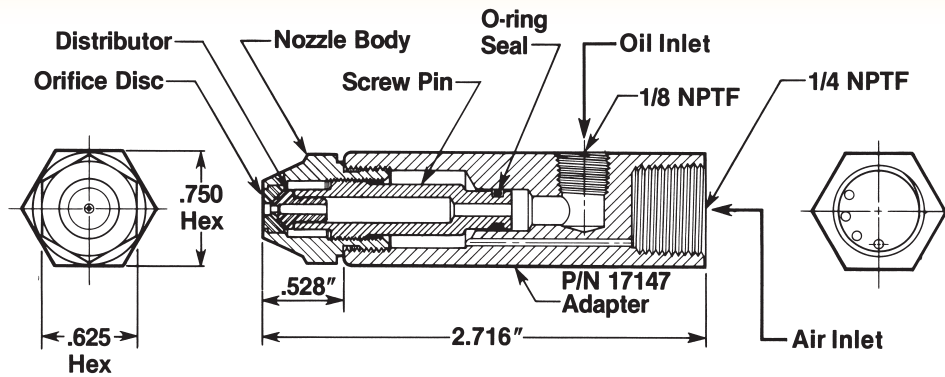

Siphon Type SNA Nozzle P/N 30609

Siphon Nozzle Capacity Chart

Part Number	Nozzle No.	3 PSIG Air		4 PSIG Air		5 PSIG Air		Lift Height (Inches)
		Fuel (GPH)	Air (CFM)	Fuel (GPH)	Air (CFM)	Fuel (GPH)	Air (CFM)	
30609-002	SNA .20	.19	.36	.23	.45	.25	.49	1
30610-001		.16	.36	.20	.45	.22	.49	4
		.14	.36	.17	.45	.20	.49	7
30609-003	SNA .30	.29	.41	.33	.49	.36	.55	1
30610-002		.26	.41	.30	.49	.33	.55	4
		.23	.41	.27	.49	.30	.55	7
30609-004	SNA .40	.38	.45	.44	.54	.49	.61	1
30610-003		.34	.45	.40	.54	.45	.61	4
		.30	.45	.36	.54	.41	.61	7
30609-005	SNA .50	.48	.50	.54	.59	.58	.65	1
30610-004		.43	.50	.50	.59	.53	.65	4
		.38	.50	.46	.59	.48	.65	7
30609-007	SNA .65	.63	.59	.72	.67	.78	.76	1
30610-005		.57	.59	.65	.67	.72	.76	4
		.51	.59	.58	.67	.66	.76	7
30609-008	SNA .75	.75	.63	.83	.74	.93	.87	1
30610-006		.65	.63	.75	.74	.84	.87	4
		.59	.63	.67	.74	.75	.87	7
30609-009	SNA .85	.87	.71	.93	.80	1.04	.93	1
30610-007		.75	.71	.85	.80	.95	.93	4
		.66	.71	.77	.80	.86	.93	7
30609-011	SNA 1.00	.96	.73	1.10	.91	1.15	1.02	1
30610-008		.84	.73	1.00	.91	1.06	1.02	4
		.72	.73	.90	.91	.97	1.02	7

* **30609 - Brass**

adapter for Brass: 17147

30610 - SST

Adapter for Stainless Steel: 29713-002

ORDERING INSTRUCTIONS: WHEN ORDERING SIPHON TYPE SNA NOZZLES, be sure to include both part number and description. Specify P/N 30609 – (see nozzle capacity chart for dash number corresponding to flow desired). Order adapter separately (specify P/N 17147). *Note: Siphon nozzles available in stainless steel. Contact customer service or your sales representative for more information*

AIRO® Air Atomizing Nozzles

for good atomization of both
light and heavy fuels at higher flow rates

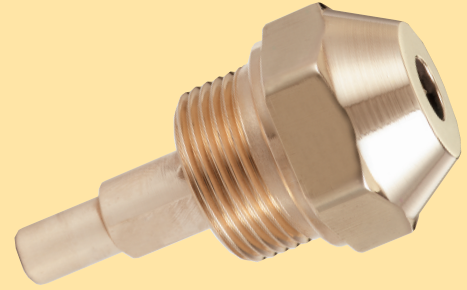

The industrial Airo Nozzle is an air atomizing nozzle designed to handle #2, #4, and preheated #5 and #6 fuels. Air is supplied at relatively low pressure to provide the energy for atomization. Air atomizing nozzles provide good atomization of fuels too viscous for pressure atomizing nozzles. They can also provide finer breakup if sufficient air is available.

The Airo Nozzle is of the internal mixing type. That means that the air and fuel are piped separately to the nozzle and are mixed just before they enter the atomizing slots. The air under pressure is mixed thoroughly with the fuel in the swirl chamber so that a uniform emulsion is discharged through the orifice. The resultant spray is well atomized in a solid cone pattern.

The cost of equipment with air atomizing nozzles is higher than for equivalent pressure atomizing nozzles because of the addition of the compressor. The power requirement is also higher because of the extra power required to compress air. These disadvantages are offset, however, by the advantages in handling of heavy fuels.

APPLICATIONS

- The Airo Nozzle may be used as a fixed discharge nozzle. (Fuel metering is discussed in a following heading.)
- This nozzle may be arranged for two-stage firing if desired.
- This type of nozzle may be arranged for complete modulating over the desired flow range.
- The Airo Nozzle will handle light fuels at any flow rate from 2 GPH and up. The proper nozzle must be selected for each range.
- The Industrial Airo Nozzle will handle #5 oil or #6 oil preheated to approximately 100 SSU. Above 20 GPH, higher viscosities may be handled if sufficient air is available.

SPRAY CHARACTERISTICS

- Uniform solid cone-spray angle varies with air pressure and flow. A separate metering device, such as an orifice, metering pump or valve is required.
- Large flow passages greatly reduce clogging.
- With the internal mixing type of nozzle, the spray angle changes with the fuel-air ratio (pounds of fuel per pound of atomizing air). The spray angle is wider at high fuel-air ratios. For example, if the spray angle is 75° at a fuel-air ratio of 30 to 1, it may be reduced to 60° at a fuel-air ratio of 10 to 1.
- Higher air pressures produce narrower spray angles.
- Droplet size is smaller at higher air pressures and narrower spray angles.
- Constant spray angles may be obtained by modulating air pressure with the fluid flow.

ADAPTERS AND SEALS

Adapters are optional and, if required, must be ordered separately. Adapters come with seals installed.

Hex Size	Part Number	Material
7/8	23034-001	Brass
	23034-002	Stainless steel
	337	Seal
1 1/4	30678-001	Mild steel
	30678-002	Stainless steel
	30678-003	Inconel
	9113	Seal

Note: Threaded screw pins require different seals. Contact customer service or your sales representative for more information.

INSTALLATION:

FUEL METERING

- A fixed firing rate may be obtained by supplying fuel by a pressure pump through a fixed metering orifice to the nozzle.
- Two stage operation may be obtained by the use of two metering orifices in the fuel line, one of them in series with a solenoid valve. This solenoid valve will be actuated by pressure or temperature.
- A positive fuel metering pump of the piston type is satisfactory for single stage operation.
- Modulating metering may be obtained by the use of a fuel pump in combination with a modulating valve.
- Metering *cannot* be done with this type of nozzle by balancing fuel pressure against air pressure.

METHODS OF METERING FUEL

- Metering pump.
- Constant pressure pump and metering orifice in the line.
- Constant pressure pump and motorized modulating valve actuated by steam pressure, water or process temperature.

AIR COMPRESSOR

- May be rotary type for pressures up to 25 PSI or as rated by manufacturer.
- May be piston type for higher pressure.
- May have built in pressure relief valve.
- Must have enough capacity for the nozzle requirement.

SPECIAL CONDITIONS:

It may be necessary when burning residual fuels to provide some means for heating the nozzle and fuel line before starting. It may also be advantageous to provide air purge of the fuel line to the nozzle on shut-down.

It is *always* advisable to make certain that air flow through the nozzle is established *before* fuel is supplied. This will prevent backing up of fuel into the air line and equipment. It will also insure good atomization at the start.

SERVICE:

- Since the fuel and air passages in this type of nozzle are quite large, clogging is not a serious problem. It is recommended, however, that both the air and the fuel be filtered to remove lint and large particles of foreign matter. Clogging of air passages or fuel passages will result in off-center fires.
- Damage to the orifice may result in a streaky fire, an off-center fire, or drooling.

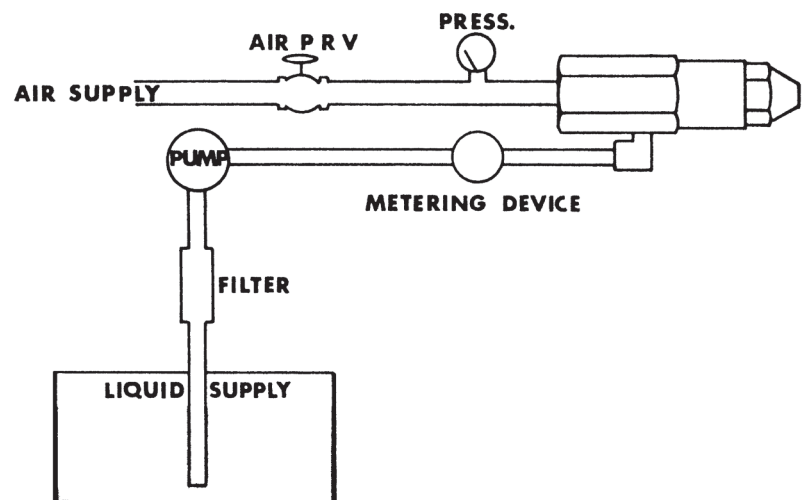

CONSTRUCTION & MATERIALS:

The Airol nozzle is made up of three basic parts, available in the following materials:

- **NOZZLE BODY** – Brass or stainless steel.
Thread sizes: 3/4"-20 UNEF on #30615 and 1-1/8"-18 UNEF on #30616.
- **DISTRIBUTOR** – Brass, stainless steel, or tungsten carbide (requires special body with replaceable tungsten carbide orifice disc, integral with body.)
- **SCREW PIN** – Brass or stainless steel.

NOTE: Contact factory for other material requirements.

DIMENSIONS AND WEIGHTS FOR AIRO NOZZLES

Nozzle Type	Material	Dimensions (Inches)				Inlet Sizes		Weight (Ounces)
		A	B	C	D	Air	Liquid	
30615-000 with 23034-001 Adapter	Brass	.625	.875 Hex	3.125	.875 Hex	1/4 NPT	1/8 NPT	7
30615-000 with 23034-002 Adapter	Stainless Steel	.625	.875 Hex	3.125	.875 Hex	1/4 NPT	1/8 NPT	8
30616-001 with 30678-000 Adapter	Stainless Steel	.800	1.25 Hex	3.620	1.25 Hex	1/2 NPT	1/4 NPT	9

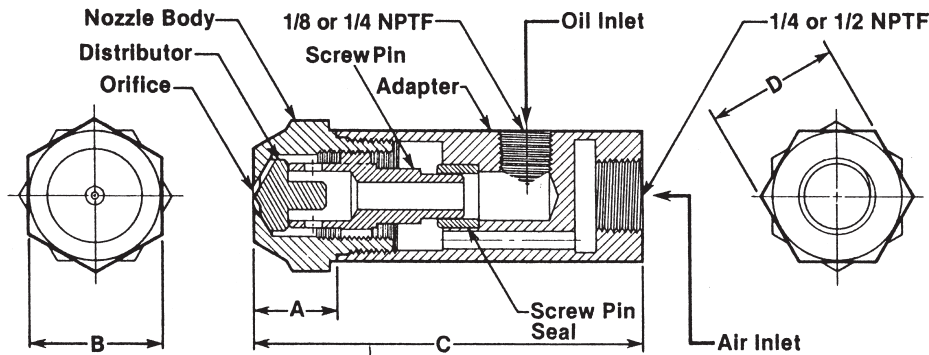

Airol Nozzle Assembly
P/N 30615 (.875" Hex) & P/N 30616 (1.250" Hex)

1 1/4" AIRO NOZZLE CAPACITIES

Part Number	Customer or Old Catalog PN	Flow Rate (GPH)	Body Material	Screw Pin Type and Material	Air Press (PSI)	Air Flow @ Max Disch (PPH)	Spray Angle (°)
30616-001	9078-60	60	SS	SS	30.0	14.5-16.0	70°
30616-004	9078-70	70	SS	SS	30.0	16.0-17.5	70°
30616-005	12581-70	70	SS	Thd'd, SS	30.0	16.0-17.5	70°
30616-008	9078-80	80	SS	SS	30.0	17.0-18.5	70°
30616-009	12581-80	80	SS	Thd'd, SS	30.0	17.0-18.5	70°
30616-011	15293-80	80	HSS	HSS	30.0	17.0-18.5	70°
30616-012	27932	80	SS	SS	30.0	20.0-22.0	75-85°
30616-014	9078-100	100	SS	SS	30.0	21.0-22.5	70°
30616-015	12581-100	100	SS	Thd'd, SS	30.0	21.0-22.5	70°
30616-017	15293-100	100	HSS	HSS	30.0	21.0-22.5	70°
30616-019	17022	100	Incon	Incon	30.0	21.0-22.5	70°
30616-020	9078-120	120	SS	SS	30.0	23.5-25.0	70°
30616-021	12581-120	120	SS	Thd'd, SS	30.0	23.5-25.0	70°
30616-024	9078-130	130	SS	SS	30.0	25.0-26.5	70°
30616-025	12581-130	130	SS	Thd'd, SS	30.0	25.0-26.5	70°
30616-027	15293-150	130	HSS	HSS	35.0	25.0-26.5	70°
30616-029	9078-150	150	SS	SS	30.0	26.0-27.5	70°
30616-030	12581-150	150	SS	Thd'd, SS	30.0	26.0-27.5	70°
30616-032	15293-150	150	HSS	HSS	30.0	23.0-24.5	70°
30616-033	19279	150	Incon	Thd'd, Incon	30.0	26.0-27.5	70°
30616-034	19810	150	Incon	Incon	30.0	26.0-27.5	70°
30616-035	9078-200	150	SS	SS	20.0	25.0-26.5	70°
30616-036	12581-200	150	SS	Thd'd, SS	20.0	25.0-26.5	70°
30616-039	14788	150	SS	SS	25.0	23.0-25.0	65°

Abbreviations: HSS—Hardened Stainless Steel Thd'd—Threaded BR—Brass Incon—Inconel
SS—Stainless Steel

7/8" Airo Nozzle Capacities

Part Number	Flow Rate (GPH)	Body Material	Screw Pin Material	Air Pressure (PSI)	Air Flow @ max PPH	Spray Angle Degrees
30615-001	10	Brass	Unthreaded Brass	20	4.6 - 4.9	70 - 80
30615-002	10	303 SST	Unthreaded 303 SST	20	4.6 - 4.9	70 - 80
30615-003	10	HT 303 SST	Unthreaded 303	20	4.6 - 4.9	70 - 80
30615-004	10	303 SST	Unthreaded Brass	20	4.6 - 4.9	70 - 80
30615-005	10	303 SST	Threaded Brass	20	4.6 - 4.9	70 - 80
30615-006	10	Brass	Threaded Brass	20	4.6 - 4.9	70 - 80
30615-007	10	303 SST	Threaded 303 SST	20	4.6 - 4.9	70 - 80
30615-009	10	Inconel	Threaded AMS 5665	20	4.6 - 5	60 - 70
30615-010	15	Brass	Unthreaded Brass	20	4.6 - 5	70 - 80
30615-011	15	303 SST	Unthreaded 303 SST	20	4.6 - 5	70 - 80
30615-012	15	HT 303 SST	Unthreaded 303 SST	20	4.6 - 5	70 - 80
30615-013	15	303 SST	Unthreaded Brass	20	4.6 - 5	70 - 80
30615-014	15	303 SST	Threaded Brass	20	4.6 - 5	70 - 80
30615-015	20	Brass	Unthreaded Brass	20	6 - 6.3	70 - 80
30615-016	20	303 SST	Unthreaded 303	20	6 - 6.3	70 - 80
30615-017	20	HT 303 SST	Unthreaded 303 SST	20	6 - 6.3	70 - 80
30615-018	20	303 SST	Unthreaded Brass	20	6 - 6.3	70 - 80
30615-019	20	303 SST	Threaded Brass	20	6 - 6.3	70 - 80
30615-020	20	Brass	Threaded Brass	20	6 - 6.3	70 - 80
30615-021	20	303 SST	Threaded 303 SST	20	6 - 6.3	70 - 80
30615-023	25	Brass	Unthreaded Brass	25	6.1 - 6.4	70 - 80
30615-024	25	303 SST	Unthreaded 303 SST	25	6.1 - 6.4	70 - 80
30615-025	25	HT 303 SST	Unthreaded 303 SST	25	6.1 - 6.4	70 - 80
30615-026	25	303 SST	Unthreaded Brass	25	6.1 - 6.4	70 - 80
30615-027	25	303 SST	Threaded 303 SST	25	6.1 - 6.4	70 - 80
30615-028	30	Brass	Unthreaded Brass	25	6.8 - 7.1	70 - 80
30615-029	30	303 SST	Unthreaded 303	25	6.8 - 7.1	70 - 80
30615-030	30	HT 303 SST	Unthreaded 303 SST	25	6.8 - 7.1	70 - 80
30615-031	30	303 SST	Unthreaded Brass	25	6.8 - 7.1	70 - 80
30615-032	30	303 SST	Threaded Brass	25	6.8 - 7.1	70 - 80
30615-033	30	Brass	Threaded Brass	25	6.8 - 7.1	70 - 80
30615-034	30	303 SST	Threaded 303 SST	25	6.8 - 7.1	70 - 80
30615-036	30	303 SST	Unthreaded Brass	30	9.5 - 10.5	70 - 80
30615-037	30	303 SST	Unthreaded Brass	30	10.2 - 11	70 - 80
30615-038	35	Brass	Unthreaded Brass	25	8 - 8.4	70 - 80
30615-039	35	303 SST	Unthreaded 303	25	8 - 8.4	70 - 80
30615-040	35	HT 303 SST	Unthreaded 303 SST	25	8 - 8.4	70 - 80
30615-041	35	303 SST	Threaded Brass	25	8 - 8.4	70 - 80
30615-042	35	303 SST	Threaded Brass	25	8 - 8.4	70 - 80
30615-043	35	Brass	Unthreaded Brass	30	16 - 18	70 - 80
30615-044	40	Brass	Unthreaded Brass	30	8.5 - 8.9	70 - 80
30615-045	40	303 SST	Unthreaded 303	30	8.5 - 8.9	70 - 80
30615-047	40	Brass	Threaded Brass	30	8.5 - 8.9	70 - 80
30615-048	40	303 SST	Threaded 303 SST	30	8.5 - 8.9	70 - 80
30615-050	40	303 SST	Unthreaded Brass	30	8.5 - 8.9	70 - 80
30615-051	40	303 SST	Threaded Brass	30	8.5 - 8.9	70 - 80
30615-052	40	303 SST	Unthreaded Brass	30	13.5 - 14.5	60 - 70
30615-053	40	Inconel	Threaded AMS 5665	30	8.5 - 9.7	60 - 70
30615-054	40	303 SST	Unthreaded Brass	30	10 - 11	70 - 80
30615-055	50	Brass	Unthreaded Brass	30	9.5 - 10.5	65 - 75
30615-056	50	303 SST	Unthreaded 303	30	9.5 - 10.5	65 - 75
30615-057	50	HT 303 SST	Unthreaded 303 SST	30	9.5 - 10.5	65 - 75
30615-058	50	303 SST	Unthreaded Brass	30	9.5 - 10.5	65 - 75
30615-059	50	303 SST	Threaded Brass	30	9.5 - 10.5	65 - 75
30615-060	50	303 SST	Threaded 303 SST	30	9.5 - 10.5	60 - 70
30615-062	50	303 SST	Unthreaded Brass	30	9.5 - 10.5	70
30615-063	50	Inconel	Unthreaded AMS	30	9.5 - 10.5	60 - 70
30615-064	50	Brass	Unthreaded Brass	30	17 - 18.5	80
30615-069	20	303 SST	Unthreaded 303 SST	20	6 - 6.3	70 - 80
30615-071	25	303 SST	Unthreaded 303	25	6.1 - 6.4	70 - 80
30615-073	30	303 SST	Unthreaded 303 SST	25	6.8 - 7.1	70 - 80
30615-075	35	303 SST	Unthreaded 303 SST	25	8 - 8.4	70 - 80
30615-077	40	303 SST	Unthreaded 303	30	8.5 - 8.9	70 - 80
30615-079	40	316 SST	Threaded 316 SST	30	8.5 - 8.9	70 - 80
30615-081	30	303 SST	Unthreaded Brass	30	10.2 - 11	70 - 80
30615-082	30	303 SST	Threaded 303 SST	30	10.2 - 11	70 - 80
30615-083	10	HT 303 SST	Unthreaded 303 SST	20	4.6 - 4.9	70 - 80
30615-084	30	303 SST	Unthreaded 303 SST	30	10.2 - 11	70 - 80
30615-085	40	303 SST	Unthreaded 303	30	13.5 - 14.5	60 - 70
30615-086	100	Brass	Unthreaded Brass	35	20 - 22	
30615-087	120	Brass	Unthreaded Brass	35	19 - 21	
30615-088	150	Brass	Unthreaded Brass	35	16 - 18	
30615-098	35	303 SST	Unthreaded 303 SST	30	16 - 18	80
30615-099	15	303 SST	Threaded 303 SST	20	4.6 - 5	70 - 80
30615-100	10	Brass	Unthreaded Brass	20	6.6 - 7	70 - 80
30615-101	50	303 SST	Unthreaded 303 SST	30	17 - 18.5	80
30615-102	120	303 SST	Unthreaded 303 SST	35	19 - 21	
30615-103	150	303 SST	Unthreaded 303	35	16 - 18	
30615-104	100	303 SST	Unthreaded 303 SST	35	20 - 22	
30615-105	20	Inconel	Threaded AMS 5665	20	6 - 6.3	70 - 80
30615-106	40	Inconel	Threaded AMS 5665	30	89.7 - 10.8	70 - 80
30615-107	10	303 SST	Unthreaded 303 SST	20	4.6 - 4.9	70 - 80

ORDERING INSTRUCTIONS

WHEN ORDERING AIRO NOZZLES, be sure to include both part number and description. To find part number and dash number, see the nozzle capacity charts. First locate the correct nozzle size and capacity, then select proper body material and screw pin type. NOTE: Please specify distributor material if different than screw pin material.

EXAMPLE: A 1-1/4" 100 GPH stainless steel nozzle with stainless steel, threaded screw pin is PN 30616-15. It will be shipped with a stainless steel distributor.

Order adapter separately. Be sure to specify part number and description.

ISO 9001 REGISTERED

DELAVAN PRODUCTS WARRANTY

New Goods or products supplied by Seller under this agreement are warranted to be, at the time of delivery of the product, free from defects in material and workmanship. The warranty period shall be ninety (90) days after installation or twelve (12) months from the date of shipment by Seller. If, at the time of delivery of the product, any such product is found to be defective in material or workmanship, Seller shall, if it confirms existence of the defect, repair or, at its option, replace such defective product at its expense and with reasonable promptness. Buyer shall provide Seller with written notice of a claimed defect within thirty (30) days after the defect becomes apparent to Buyer but in no event later than one year from the date of shipment of the Goods to Buyer. Said notice will contain reasonable proof that the claimed defect is covered by Seller's warranty. Seller's obligation hereunder is further conditioned upon return of the defective Goods to Seller within such period. The warranty period for Goods or parts thereof that have been repaired or replaced shall be three (3) months or the remainder of the original warranty period, whichever is greater.

Warranty Exclusions: Seller's warranty does not extend to any Goods which i) have been subjected to misuse, neglect, accident, improper, unintended or non-conforming installations; or ii) are used for purposes not included or not in accordance with Seller's prescribed operational maintenance procedures and instructions; or iii) which have been repaired or altered by Buyer or persons other than Seller (except as otherwise authorized by Seller) using practices that do not conform with Seller's prescribed maintenance and repair procedures; or iv) which have been damaged by secondary causes which are inconsistent with applicable product specifications, including but not limited to, improper voltages, adverse or extreme environmental conditions, improper signals, or products which have had their serial number or any part thereof altered, defaced, or removed.



“Spray Technologies”

P.O. Box 969 • Bamberg, South Carolina 29003

PHONE: (803) 245-4347 • FAX: (803) 245-4146

1.800.982.6943

www.delavan.com

email: delavansales@collins.com



Collins Aerospace

1709W-2019
©Delavan Spray, LLC.
Printed in the U.S.A.