



Residential
Grilles, Registers & Diffusers
Edition 11





- Contact your customer service representative or territory sales manager for pricing and availability.
- Free freight when your total spend is a minimum of \$2600.*

Thousands of HVAC products ready to ship.



heatfab.



Residential Vent & Chimney

Vent:

Standard efficiency b-vent, high efficiency polypropylene, special gas vent for condensing, near-condensing, and non-condensing vent systems. Stock residential diameters and system components available in 3" – 14". Additional sizes available up to 30". Direct vent systems also available. Premium quality materials and designs backed by UL standards.

Chimney:

All fuel chimney systems for venting wood, coal, oil, or gas. Available in residential diameters 4" – 8". Additional sizes available up to 24". Pellet venting systems for gas, wood pellet, and bio-fuels. Stainless steel inner and outer materials. Variety of installer friendly components backed by UL standards.

Chimney Liner:

Aluminum and stainless steel. Lengths available up to 50'. Standard diameters available up to 8". Variety of installer friendly components backed by UL standards.



Grilles, Registers, & Diffusers

A full line for residential and commercial applications. Offered in steel, aluminum and plastic. Many sizes in stock for quick shipment.



Flexible Air Duct

Flexible air duct systems UL Greenguard Gold certified for residential and commercial applications. Complete line of R-4.2, R-6.0, and R-8.0 available in many outer jacket and core combinations from 3" - 24" diameters and 25' - 50' lengths. Flexible aluminum, duct, duct sleeves and uninsulated flex duct also available.

MILCOR.

Interior Access Doors

Access Doors – High quality and affordable interior access doors for all types of requirements. In stock or custom.



Roof Top Products

New construction and retrofit drain systems, flashings, expansion joint covers, equipment rails and curbs, duct supports and pipe mounting pedestals. In stock, or made to order.

WARD®

Duct Components

Components and accessories for the residential and commercial HVAC and sheet metal industries including flange, rail, corners, hangers & strapping, and duct access doors.



Filters

A complete line of Multi-Pleat or Commercial & Industrial Disposable panel filters, available in fiberglass and polyester.

*Some restrictions may apply.

RESIDENTIAL

	Product Information	Engineering Data
RESIDENTIAL CONSTRUCTION FEATURES	5	
FLOOR REGISTERS & GRILLES		
210 Steel (Floor) Register	6	35
265 Steel (Floor) Return Grille	6	35
411 Steel (Floor) Diffuser	6	35
420 Steel Toe-Space Grille	7	36
421 Steel (Floor) Diffuser Enamel	7	36
350 Steel (Floor) Diffuser Powder Coat	7	36
531 Aluminum (Floor) Diffuser	7	36
RZ-Floor Rezzin™ Two-Way Floor Diffuser	8	36
BASEBOARD REGISTERS & GRILLES		
406 Steel (Baseboard) Diffuser, 15" or 18"	9	37
407 Steel (Baseboard) Return Grille	9	
462 Steel (Baseboard) Diffuser	9	37
464 Steel (Baseboard) Diffuser	9	37
654 Steel (Baseboard) Register	10	37
655 Steel (Baseboard) Register	10	37
657 Steel (Baseboard) Return Grille	10	37
658 Steel (Baseboard) Return Grille	11	37
664 Steel (Baseboard) Register	11	37
674 Steel (Baseboard) Return Grille	11	42
SIDEWALL/CEILING REGISTERS & GRILLES		
301 (A301) Steel (Stamped Aluminum) Curved Blade One-Way	12	38
302 (A302) Steel (Stamped Aluminum) Curved Blade Two-Way	12-13	38
303 (A303) Steel (Stamped Aluminum) Curved Blade Three-Way	13	38
304 (A304) Steel (Stamped Aluminum) Curved Blade Four-Way	14	38
300M Series Stamped Curved-Blade Register with Multi-Louver Damper	15	38
A611 Stamped Aluminum Curved Blade Register One-Way, MS/OB	16	39
A612 Stamped Aluminum Curved Blade Register Two-Way, MS/OB	16	39
A613 Stamped Aluminum Curved Blade Register Three-Way, MS/OB	16	30
A614 Stamped Aluminum Curved Blade Register Four-Way, MS/OB	17	39
A618 Stamped Aluminum Straight Blade Register, MS/OB	17	40
631 Stamped Steel Three-Way Register	18	41
650 (A650) Stamped Steel/Aluminum Return Grille	18	41
651 Stamped Steel Register	19	41
659 Stamped Steel Filter Grille	19	41
661 (A661) Stamped Steel/Aluminum Two-Way Register	20	42
672 Stamped Steel Return Grille	21	42
673 Stamped Steel Filter Grille	21	42
681 (A681) Stamped Steel One-Way Register	21	43
682 (A682) Stamped Steel Two-Way Register	22	43
683 (A683) Stamped Steel Three-Way Register	22	43
684 (A684) Stamped Steel Four-Way Register	22	43
680-OB Series Stamped Faced Opposed Blade Damper Register	23	
680M Series Stamped Lanced-Blade Register with Multi-Louver Damper	24	43

RESIDENTIAL

		Product Information	Engineering Data
A711	Stamped Aluminum One-Way, Sidewall/Ceiling Register MS	25	
A712	Stamped Aluminum Two-Way, Sidewall/Ceiling Register MS	25	
A713	Stamped Aluminum Three-Way, Sidewall/Ceiling Register MS	25	
A714	Stamped Aluminum Four-Way, Sidewall/Ceiling Register MS	25	
A718	Stamped Aluminum Straight Blade Register, MS	25	
REZZIN™ REGISTERS & DIFFUSERS			
2-WAY	Rezzin™ Sidewall/Ceiling Register, Double Deflection	26	44
3-WAY	Rezzin™ Sidewall/Ceiling Register, Three-Way Deflection	26	44
4-WAY	Rezzin™ Sidewall/Ceiling Diffuser	26	44
Doors			
HCAD	Access Door		27
CEILING DIFFUSERS			
11	Steel Duct Ring	28	
12	Steel Butterfly Damper with Ring	28	
16	Steel Round (Ceiling) Diffuser	28	45
24	Steel Square (Ceiling) Diffuser	29	45
21	Steel Square Mounting Frame	29	
22	Steel Butterfly Damper with Mounting Frame	29	
23	Steel Opposed Blade Damper	30	
A501	Aluminum Square Diffuser One-Way, MS/OB	30	46
A502	Aluminum Square Diffuser Two-Way, MS/OB	30	46
A503	Aluminum Square Diffuser Three-Way, MS/OB	31	46
A504	Aluminum Square Diffuser Four-Way, MS/OB	31	46
A505	Aluminum Square Diffuser Four-Way Corner, MS/OB	31	46
ECFM	Evaporative Cooler Aluminum Diffuser	33	48
RZ-Square	Rezzin™ Square Ceiling Diffuser	32	47
RZ-Round	Rezzin™ Round Ceiling Diffuser	32	47
	Rezzin™ Rough-In Plates	32	

ENGINEERING DATA

Engineering Data	33
Using the Engineering Data	33
Recommended Noise Criteria	33
Glossary of Terms	48
Alpha-Numeric Product Index	49

Residential Grilles, Registers & Diffusers

No one satisfies the demands for air distribution solutions better than *Hart & Cooley, Inc.* Our wide selection of grilles, registers, diffusers and accessories includes a variety of shapes and sizes to meet any application and budget requirement.

Our products are offered in steel, aluminum or plastic construction, and are designed for installation ease. They are made with an attention to detail that contributes to unmatched performance.

For example: an electro-deposition paint finish creates a flawless appearance; stamped face margins eliminate mitered corners and rough edges; each product is identified with a unique bar code label; and shrink-wrap packaging makes sure products are delivered in perfect condition. The wide variety of fin spacings, air patterns, and damper controls assures an appropriate solution for each application.

A nationwide distribution network provides for consistent product availability and timely delivery.

HAVE ADDITIONAL QUESTIONS?

We invite you to call us for more information on how our products can provide you with winning, comprehensive and confident solutions that save you time and money. 1-800-433-6341

Floor Registers & Grilles



210 Floor Register

- All-steel construction
- Provides firm, smooth surface
- Extremely rigid
- Free area averages over 75%
- Toe-operated valve control
- Golden Sand enamel finish

210 Standard Sizes (in.)						
W	HEIGHT					
	4		X	X	X	X
6	X	X	X	X	X	X
8		X	X	X	X	
9				X		
10			X	X	X	
12				X	X	

End View Showing Depth with Valve Open:

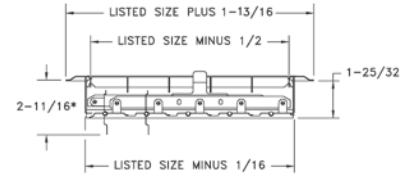

*3-9/16 FOR SIZES OVER 14 x 20



265 Floor Return Air Grille

- All-steel construction
- Provides firm, smooth surface
- Extremely rigid
- Free area averages over 75%
- Golden Sand enamel finish

265 Standard Sizes (in.)											
W	HEIGHT										
	4	X	X	X	X		X		X		X
6		X	X	X	X	X	X	X		X	X
8	X	X	X	X	X	X	X	X		X	
9			X								
10		X	X	X	X	X	X	X		X	
12			X	X	X	X	X	X		X	
14				X	X		X	X		X	
16					X		X	X		X	
18						X		X		X	
20							X	X	X	X	
24								X		X	X

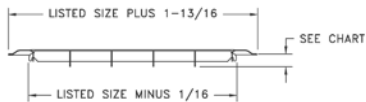

411 Deluxe Floor Diffuser

- All-steel construction
- Heavy-gauge individually welded diffusion vanes
- Multi-angle fin setting
- Foot-operated dial control
- Can be used in high traffic areas
- Golden Sand or Bright White enamel finish

411 Available Sizes (in.)	
Size	Free Area Sq. In.
2 x 10	15
2 x 12	19
2 x 14	22
4 x 10	29
4 x 12	35
4 x 14	40
6 x 10	44
6 x 12	53
6 x 14	60

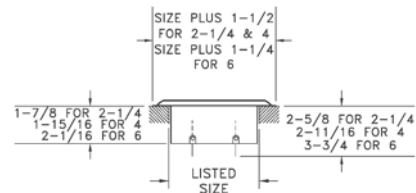
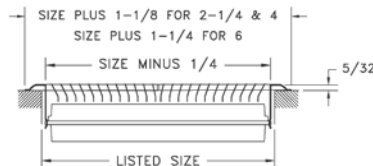



420 Toe-Space Grille

- All-steel construction
- Heavy-gauge stamped face
- Multi-angle fins
- Golden Sand or Bright White enamel finish

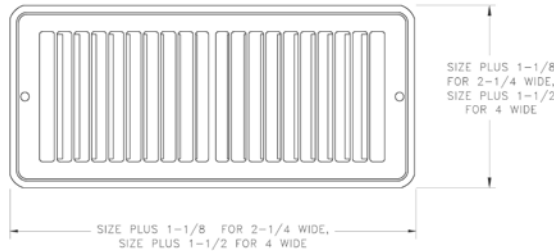
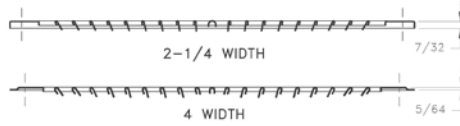

420 Available Sizes (in.)	
Size	Free Area Sq. In.
10 x 2	15
12 x 2	17
14 x 2	20
10 x 4	27
12 x 4	32
14 x 4	37



421 Floor Diffuser—Enamel

350 Floor Diffuser—Powder Coat

- All-steel construction
- Multi-angle fin setting
- Rolled fin for strength and safety
- Welded construction
- Heavy-gauge stamped face
- 421 available colors: Golden Sand or Bright White
- 350 available colors: Golden Sand, Bright White, Hickory Dark Java or Silver Maple Grey

421/350 Available Sizes (in.)	
Size	Free Area Sq. In.
2 x 10	15
2 x 12	17
2 x 14	20
4 x 8	22
4 x 10	27
4 x 12	32
4 x 14	37
6 x 10	39
6 x 12	48
6 x 14	56

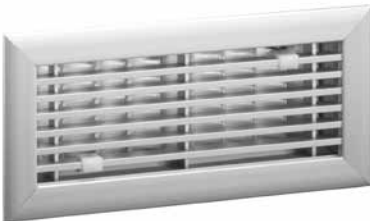
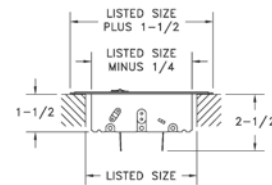
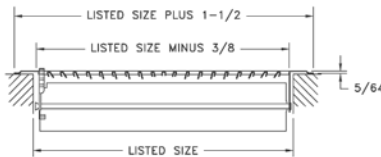

531 Royale® Floor Diffuser

- Extruded aluminum construction
- Corrosion-resistant, high strength
- Heavy cross-bracing at strategic intervals
- Dual multi-shutter valves for adjustable air pattern
- Nylon slide valve operators
- Satin-anodized finish

531 Available Sizes (in.)	
Size	Free Area Sq. In.
2.25 x 10	10
2.25 x 12	12
2.25 x 14	14
4 x 10	19
4 x 12	23
4 x 14	27
6 x 10	31
6 x 12	37
6 x 14	44

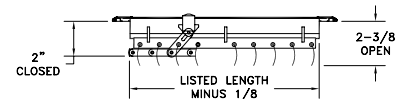
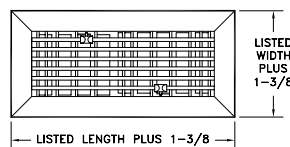
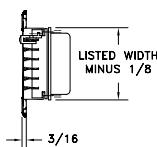

Floor Registers & Grilles

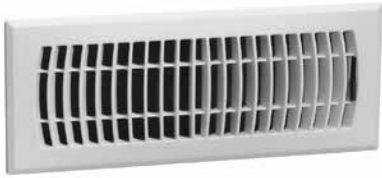

Rezzin Plastic Floor Diffuser

- Solid ABS construction for floor use
- Multi-angled fins for fan pattern of air distribution
- Foot-operated, opposed-blade damper
- Bright White or Brown finish

Available Sizes (in.)		
HT	WIDTH	
	2	10
4	X	X

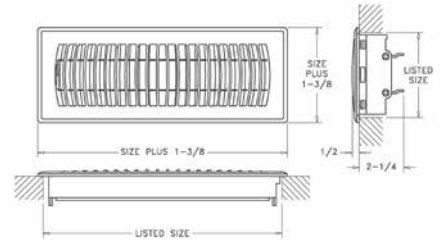



15" face

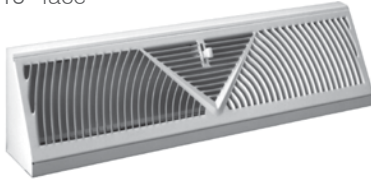

18" face

406 Baseboard Diffuser

- All-steel construction
- Blankets wall or window area
- Golden Sand or Bright White enamel finish

Model Number	Size	Free Area Sq. In.	Overall Length	Height	Base Projection	Opening Width
406	15"	32	15	4 1/2	2 3/4	12
406	18"	38	18	4 1/2	2 13/16	12
407	18"	38	18	4 1/2	2 13/16	12

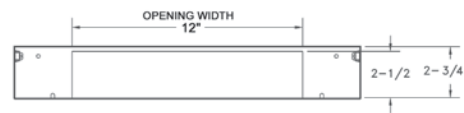
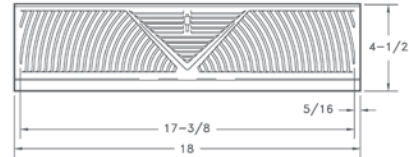

BOTTOM VIEW

406 18" Shown

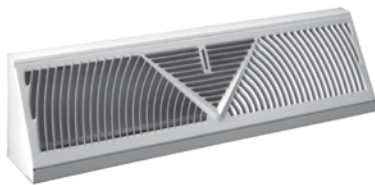

407 Matching Return Air Grille

- All-steel construction
- Complementary return air grille for Model 406 supply
- Golden Sand or Bright White enamel finish

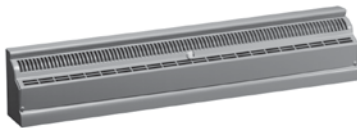

462 Baseboard Diffuser

- All-steel construction
- Two-foot length
- Airfoil valves reduce resistance
- Equal air distribution over the length of the diffuser
- Face can be easily removed
- Golden Sand or Bright White enamel finish

Model Number	Size	Free Area Sq. In.	Overall Length	Height	Base Projection	Bottom Opening
462	2'	27	24	4 1/2	2 23/32	2 5/16 X 16



BOTTOM VIEW OF NO. 462

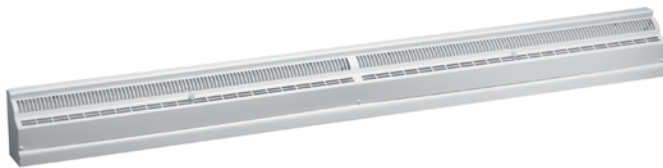

464 Baseboard Diffuser

- All-steel construction
- Four-foot length
- Airfoil valves reduce resistance
- Equal air distribution over the length of the diffuser
- Dual valves
- Face can be easily removed
- Golden Sand or Bright White enamel finish

Model Number	Size	Free Area Sq. In.	Overall Length	Height	Base Projection	Bottom Opening
464	4'	54	48	4 1/2	2 23/32	2 5/16 X 24



BOTTOM VIEW OF NO. 464

Baseboard Registers & Grilles



654 Baseboard Register with Damper

- One-piece steel construction
- 1/3" spaced fins set at 20 degrees
- 7/8" margin turnback
- Exceptional free area
- Positive volume-control damper
- Bright White enamel finish

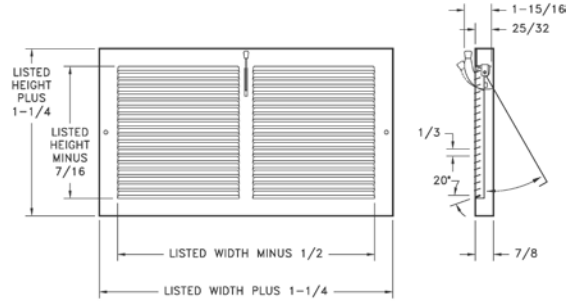

655 Baseboard Register with Damper

- All-steel construction
- 1/3" spaced fins set at 20 degrees
- Volume-control damper
- Bright White enamel finish

655 Available Sizes (in.)				
HT	WIDTH			
	6	X	X	X

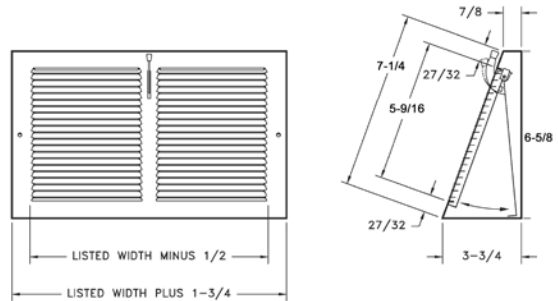

657 Baseboard Return Air Grille

- One-piece steel construction
- 1/3" spaced fins set at 20 degrees
- 7/8" margin turnback
- Exceptional free area
- Install with fins upward or downward for best duct concealment
- Complementary return air grille for Model 654 or 664 supply
- Golden Sand or Bright White enamel finish

657 Standard Sizes (in.)								
HT	WIDTH							
	4			X				
6	X	X	X	X	X	X	X	X
8	X	X	X	X	X	X	X	X
10			X		X	X	X	
12			X			X	X	

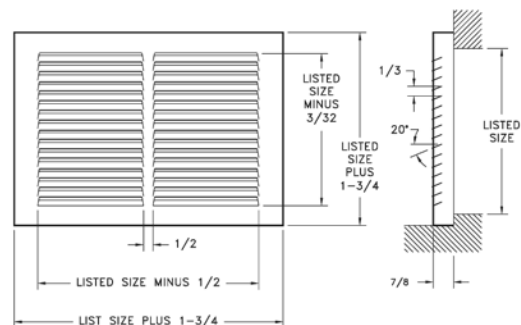



658 Baseboard Return Air Grille

- All-steel construction
- 1/3" spaced fins set at 20 degrees
- Complementary return air grille for Model 655 supply
- Bright White enamel finish

658 Available Sizes (in.)					
HT	WIDTH				
		10	12	14	24
6	X	X	X	X	X
8			X	X	X

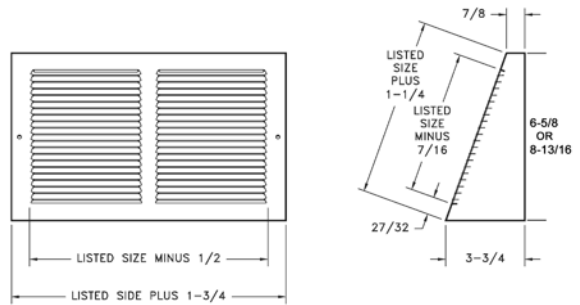

664 Baseboard Register

- All-steel construction
- 1/3"-spaced fins set at 20 degrees
- 7/8" margin turnback
- 1-5/8" depth when fully opened
- Exceptional free area
- Ideal for shallow duct installations
- Multi-shutter valve
- Bright White enamel finish

664 Available Sizes (in.)				
HT	WIDTH			
		8	10	12
6	X	X	X	X
8			X	

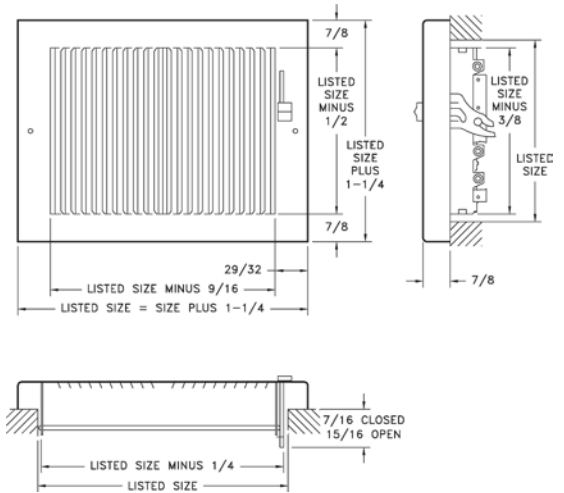

674 Return Air Grille

- One-piece steel construction
- 1/2"-spaced fins set at 40 degrees
- 7/8" margin turnback
- Complementary return air grille for 1/2"-spaced products
- Bright White enamel finish

674 Available Sizes (in.)			
HT	WIDTH		
		14	24
6	X	X	X
8	X	X	X

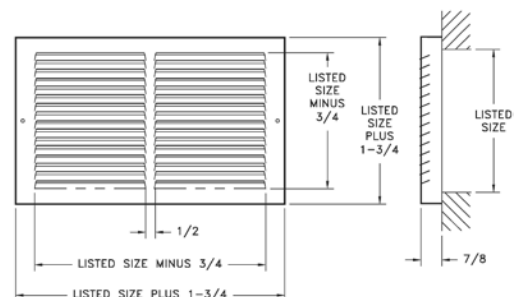

Sidewall Registers & Grilles



301 Register

- All-steel one-piece stamped-face curved-blade construction
- One-way deflection
- One-way air pattern
- For sidewall or ceiling application
- Multi-shutter valve
- Listed heights 10" and larger require double valves
- Bright White enamel finish

301 Available Sizes (in.)					
HT	WIDTH				
	6	8	10	12	14
4		X	X	X	X
6	X	X	X	X	X
8		X	X	X	X
10			X		
12				X	

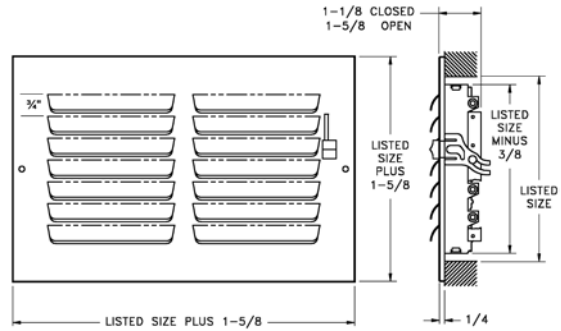

A301 Register

- Aluminum one-piece stamped-face curved-blade construction
- For sidewall or ceiling application
- One-way deflection
- One-way air pattern
- Galvanized multi-shutter valve
- Listed heights 10" and larger require double valves
- Bright White enamel finish

A301 Available Sizes (in.)					
HT	WIDTH				
	6	8	10	12	14
4		X	X	X	
6	X	X	X	X	X
8		X	X	X	X
10			X		

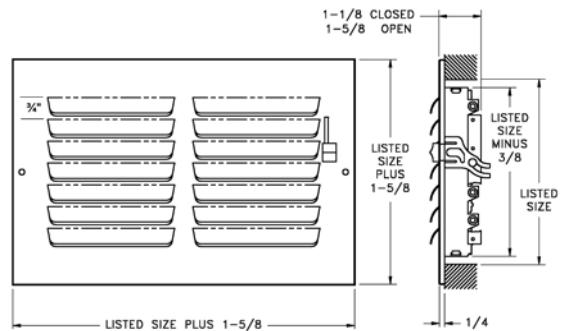

302 Register

- All-steel one-piece stamped-face curved-blade construction
- Two-way deflection
- Two-way air pattern
- For sidewall or ceiling application
- Multi-shutter valve
- Listed heights 10" and larger require double valves
- Bright White enamel finish

302 Available Sizes (in.)				
HT	WIDTH			
	8	10	12	14
4	X			
6		X	X	X
8	X	X	X	X

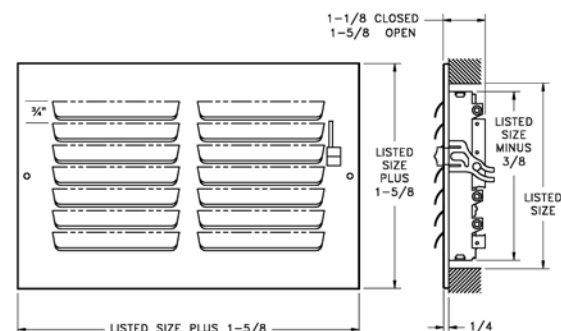

Sidewall Registers & Grilles



A302 Register

- Aluminum one-piece stamped-face curved-blade construction
- For sidewall or ceiling application
- Two-way deflection
- Two-way air pattern
- Galvanized multi-shutter valve
- Listed heights 10" and larger require double valves
- Bright White enamel finish

A302 Available Sizes (in.)		
HT	WIDTH	
		10
6	X	X
8		X
10	X	

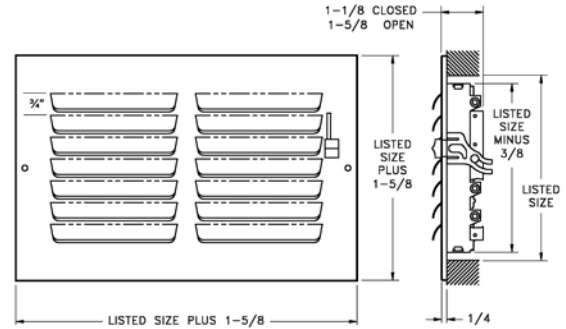

303 Register

- All-steel one-piece stamped-face curved-blade construction
- Three-way deflection
- Three-way air pattern
- For sidewall or ceiling application
- Multi-shutter valve
- Listed heights 10" and larger require double valves
- Bright White enamel finish

303 Available Sizes (in.)						
HT	WIDTH					
		6	8	10	12	14
4		X	X		X	
6	X	X	X	X	X	X
8		X	X	X	X	
10			X			
12				X		

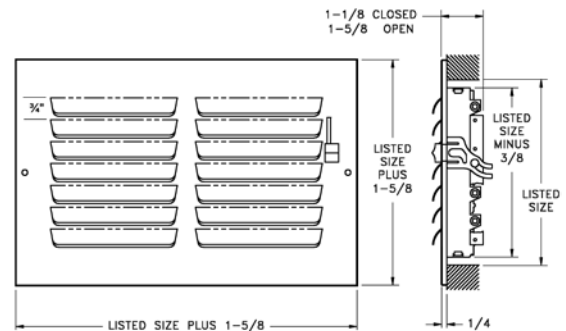

A303 Register

- Aluminum one-piece stamped-face curved-blade construction
- For sidewall or ceiling application
- Three-way deflection
- Three-way air pattern
- Galvanized multi-shutter valve
- Listed heights 10" and larger require double valves
- Bright White enamel finish

A303 Available Sizes (in.)				
HT	WIDTH			
		6	8	10
4		X		
6	X		X	X
8		X	X	X
10			X	
12				X

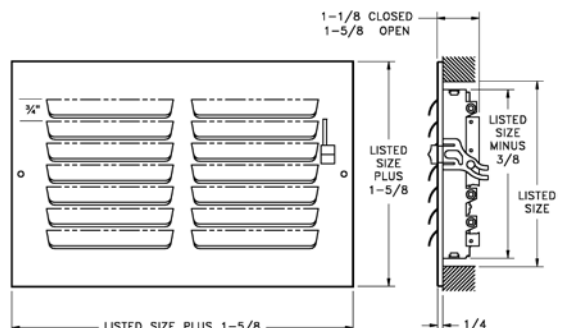

Sidewall Registers & Grilles



304 Register

- All-steel one-piece stamped-face curved-blade construction
- Four-way deflection
- Four-way air pattern
- For sidewall or ceiling application
- Multi-shutter valve
- Listed heights 10" and larger require double valves
- Bright White enamel finish

304 Available Sizes (in.)					
HT	WIDTH				
		6	8	10	12
6	X				
8		X			
10			X		
12				X	
14					X

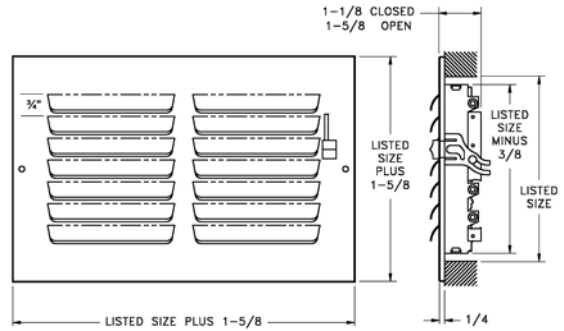

A304 Register

- Aluminum one-piece stamped-face curved-blade construction
- For sidewall or ceiling application
- Four-way deflection
- Four-way air pattern
- Galvanized multi-shutter valve
- Listed heights 10" and larger require double valves
- Bright White enamel finish

A304 Available Sizes (in.)				
HT	WIDTH			
		6	8	10
6	X			
8		X		
10			X	
12				X

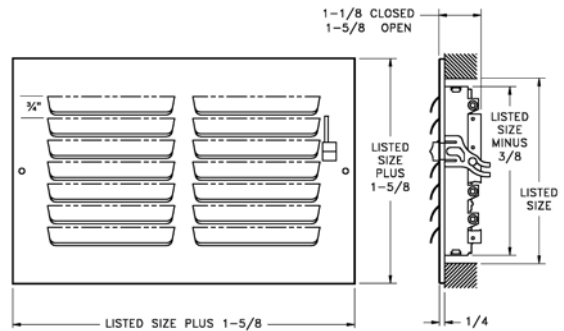



300M Series Register

- All-steel construction with metal handle
- Stamped curved-blade supply register with multi-louver damper for ceiling or sidewall installation
- Stamped, one-piece face with multi-louver damper for volume control
- Available in 1-way, 2-way, 3-way and 4-way airflow patterns
- Bright White finish

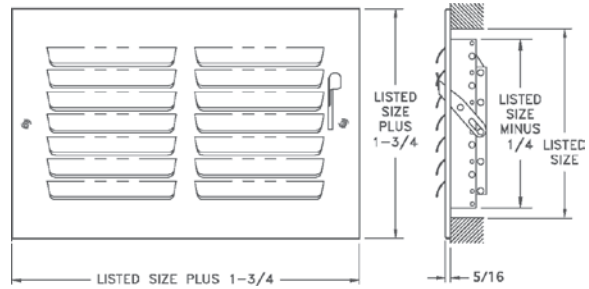

301M Available Sizes (in.)					
HT	WIDTH				
	6	8	10	12	14
4		X		X	
6	X	X	X	X	X
8		X	X	X	X
10			X		X
12				X	



302M Available Sizes (in.)		
HT	WIDTH	
	10	12
6	X	X
8	X	X
10	X	
12		X



303M Available Sizes (in.)					
HT	WIDTH				
	6	8	10	12	14
4		X			
6	X	X	X	X	X
8		X	X	X	X
10			X		X
12				X	



304M Available Sizes (in.)					
HT	WIDTH				
	6	8	10	12	14
6	X				
8		X			
10			X		
12				X	
14					X

Sidewall Registers & Grilles

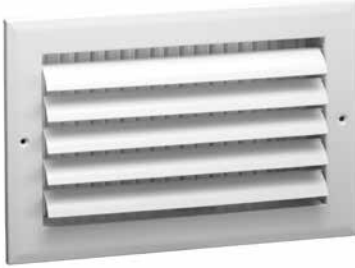

A611MS/A611OB Register

- Aluminum face/fin construction
- For sidewall or ceiling application
- One-way deflection
- Adjustable curved blades increase deflection control
- Galvanized multi-shutter valve or opposed-blade damper
- Bright White finish

A611 Available Sizes (in.)					
HT	WIDTH				
	6	8	10	12	14
4		X	X	X	
6	X		X	X	X
8		X	X	X	X
10			X		
12				X	

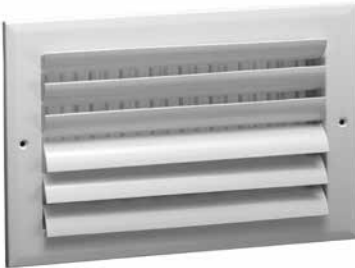
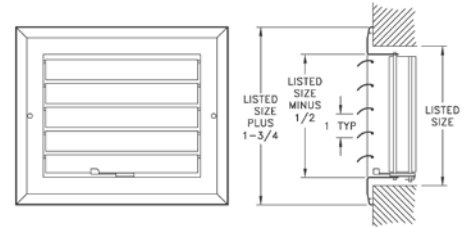
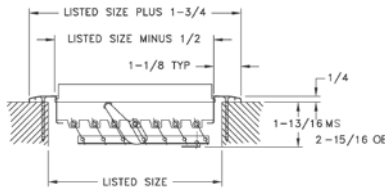

A612MS/A612OB Register

- Aluminum face/fin construction
- For sidewall or ceiling application
- Two-way deflection
- Adjustable curved blades increase deflection control
- Galvanized multi-shutter valve or opposed-blade damper
- Bright White finish

A612 Available Sizes (in.)				
HT	WIDTH			
	8	10	12	14
6		X	X	X
8	X		X	X
10		X		
12			X	

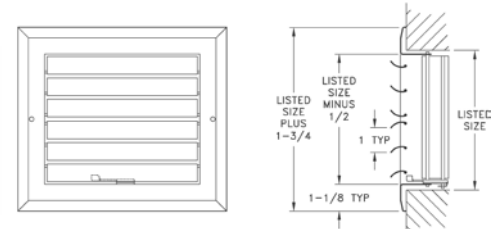
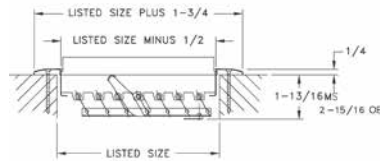

A613MS/A613OB Register

- Aluminum face/fin construction
- For sidewall or ceiling application
- Three-way deflection
- Adjustable curved blades increase deflection control
- Galvanized multi-shutter valve or opposed-blade damper
- Bright White finish

A613 Available Sizes (in.)					
HT	WIDTH				
	6	8	10	12	14
4		X	X		
6	X		X	X	X
8		X		X	X
10			X		
12				X	
14					X

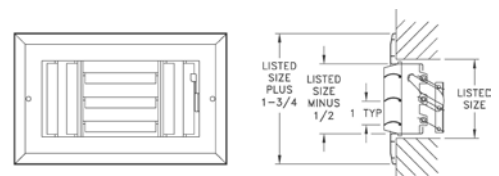
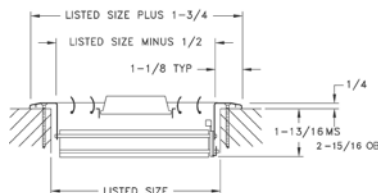

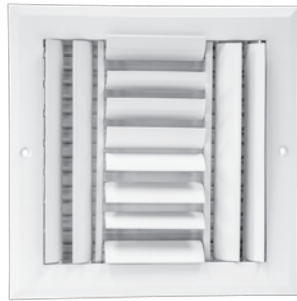

A614MS/A614OB Register

- Aluminum face/fin construction
- For sidewall or ceiling application
- Four-way deflection
- Adjustable curved blades increase deflection control
- Galvanized multi-shutter valve or opposed-blade damper
- Bright White finish

A614 Available Sizes (in.)					
HT	WIDTH				
	6	8	10	12	14
6	X				
8		X			
10			X		
12				X	
14					X

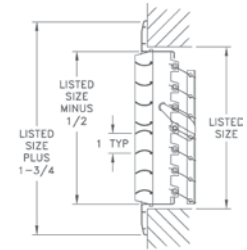
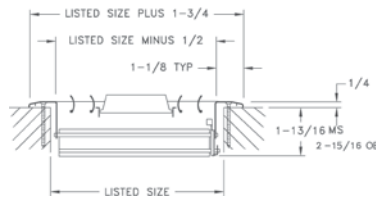

A618MS/A618OB Register

- Aluminum face/fin construction
- Adjustable straight fins provides individual deflection control
- Stamped face margins eliminate mitered corners and rough edges
- Galvanized multi-shutter valve or opposed-blade damper
- Bright White finish

A618 Available Sizes (in.)					
HT	WIDTH				
	6	8	10	12	14
4		X	X	X	X
6	X	X	X	X	X
8		X	X	X	X
10			X		
12				X	
14					X

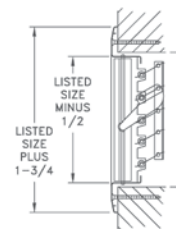
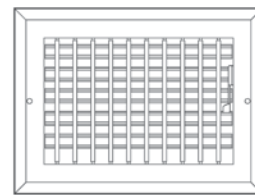
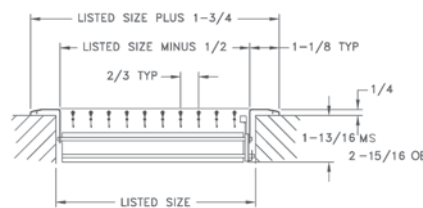

Sidewall Registers & Grilles



631 Register

- All-steel construction
- Ideal for shallow duct installations
- Used for ceiling or sidewall installations
- For heating or cooling
- Three-way deflection
- 1/3" spaced fins set at 20 degrees
- Multi-shutter valve
- 1-5/8" depth when fully opened
- Interlocking valve louvers for positive shut-off
- Bright White finish

631 Available Sizes (in.)					
HT	WIDTH				
	8	10	12	14	16
4	X	X	X	X	
6	X	X	X	X	X
8		X	X	X	

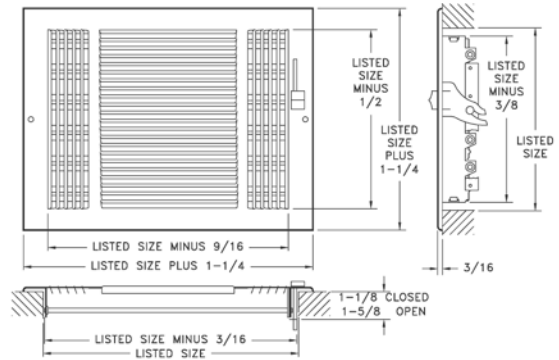

650 Return Air Grille

- All-steel construction
- 1/3" spaced fins set at 20 degrees
- Exceptional free area
- 5/16" Margin Turnback
- Bright White finish

650 Available Sizes (in.)												
HT	WIDTH											
	6	8	10	12	14	16	18	20	24	30	36	
4	X	X	X	X	X	X		X	X	X		
6	X	X	X	X	X	X	X	X	X	X	X	
8		X	X	X	X	X	X	X	X	X	X	
10	X		X	X	X	X	X	X	X	X	X	
12			X	X	X	X	X	X	X	X	X	
14	X	X	X	X	X	X	X	X	X	X		
16				X	X	X	X	X	X	X		
18				X	X		X	X	X	X		
20			X	X	X	X		X	X	X		
24	X		X	X	X	X	X	X	X	X		
25								X				
30					X			X	X	X		

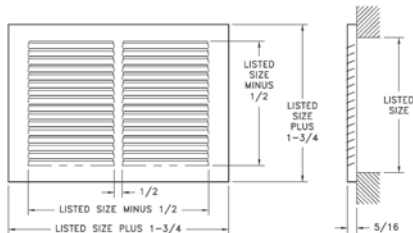

Note: When ordering, specify horizontal dimension first.



A650 Return Air Grille

- Aluminum construction
- 1/3" spaced fins set at 20 degrees
- Exceptional free area
- 5/16" Margin Turnback
- Bright White finish

A650 Available Sizes (in.)					
HT	WIDTH				
	6	10	12	14	18
6	X		X		
8				X	
10		X			
12			X		X
14				X	

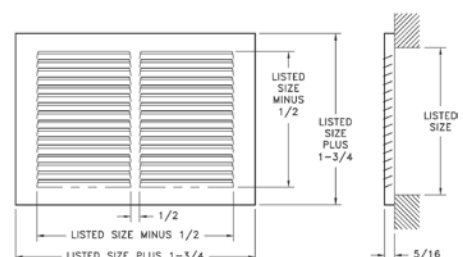

Sidewall Registers & Grilles



651 Register

- All-steel construction
- 1/3" spaced fins set at 20 degrees
- Volume-control damper
- Bright White finish

651 Available Sizes (in.)				
HT	WIDTH			
	8	10	12	14
4	X	X	X	
6	X	X	X	X

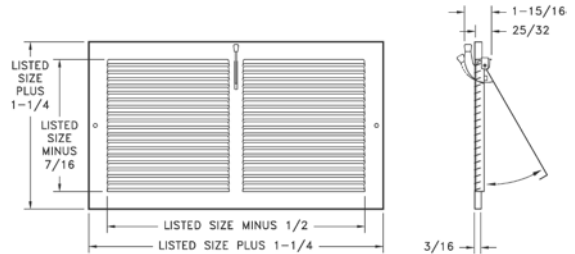

659 Return Air Filter Grille

- All-steel construction
- 1/3" spaced fins set at 20 degrees
- Effectively conceals filter
- Use standard 1" thick disposable filters (not included)
- Removable face for easy installation and cleaning
- Equipped with adjustable filter retainers
- Bright White finish

659 Standard Sizes (in.)										
HT	WIDTH									
	10	12	14	16	18	20	24	25	30	36
6		X	X				X		X	
8							X		X	
10	X					X	X		X	
12		X			X	X	X		X	
14			X			X	X	X	X	X
16				X		X	X	X	X	
18					X		X		X	
20	X	X	X	X		X	X	X	X	
24		X	X		X	X	X		X	
25			X	X		X		X		
30			X	X		X	X		X	
36							X			

Note: When ordering, specify horizontal dimension first.

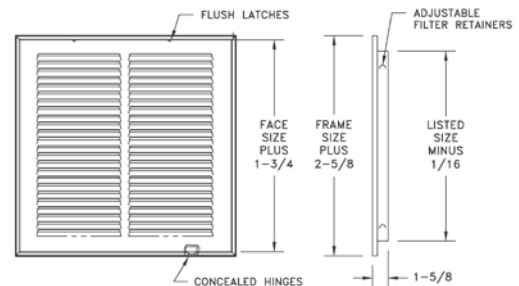

Sidewall Registers & Grilles



661 Register

- All-steel construction
- Used for ceiling or sidewall installations
- For heating or cooling
- Ideal for shallow duct installations
- Two-way deflection
- 1/3" spaced fins set at 20 degrees
- Galvanized multi-shutter valve
- 1-5/8" depth when fully opened
- Interlocking valve louvers for positive shut-off
- Bright White finish

Available with fusible link option, limited sizes (not UL-listed or fire-rated)

661 Standard Sizes (in.)										
HT	WIDTH									
	6	8	10	12	14	16	18	20	24	30
4	X	X	X	X	X	X			X	
5		X	X	X	X					
6	X	X	X	X	X	X	X	X	X	X
8		X	X	X	X	X	X	X	X	X
10			X	X						
12				X						

Note: When ordering sidewall products, specify horizontal (width) dimension first.

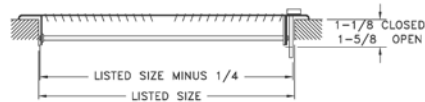
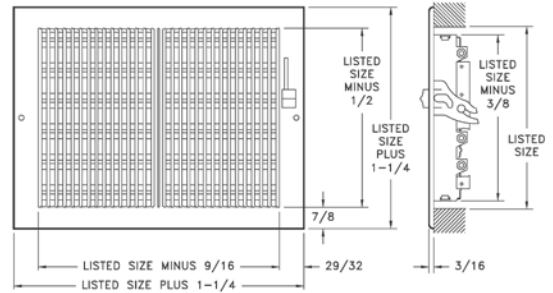

A661 Register

- Stamped aluminum construction
- Used for ceiling or sidewall installations
- For heating or cooling
- Ideal for shallow duct installations
- Two-way deflection
- 1/3" spaced fins set at 20 degrees
- Galvanized multi-shutter valve
- 1-5/8" depth when fully opened
- Interlocking valve louvers for positive shut-off
- Bright White finish

A661 Available Sizes (in.)				
HT	WIDTH			
	8	10	12	14
4	X	X	X	
6		X	X	X

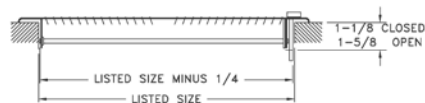
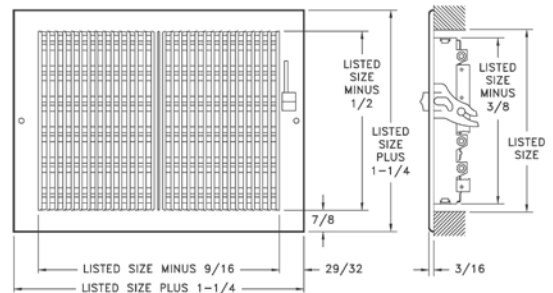

Sidewall Registers & Grilles



672 Return Air Grille

- All-steel construction
- 1/2" spaced fins set at 40 degrees
- Exceptional free area
- 5/16" Margin Turnback
- Bright White finish

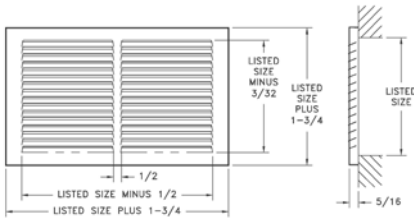

		672 Available Sizes (in.)											
		WIDTH											
HT		6	8	10	12	14	16	18	20	24	25	30	36
4	X	X	X	X	X	X	X	X	X	X	X	X	X
6	X	X	X	X	X	X	X	X	X	X	X	X	X
8		X	X	X	X	X	X	X	X	X	X	X	X
10			X	X	X	X	X	X	X	X	X	X	X
12	X		X	X	X	X	X	X	X	X	X	X	X
14		X	X	X	X	X	X	X	X	X	X	X	X
16				X	X	X	X	X	X	X	X	X	X
18				X	X	X	X	X	X	X	X	X	X
20			X	X	X	X	X	X	X	X	X	X	X
24			X	X	X	X	X	X	X	X	X	X	X
25					X	X		X		X			
30					X	X		X	X			X	



673 Return Air Filter Grille

- All-steel construction
- 1/2" spaced fins set at 40 degrees
- Effectively conceals filter
- Use standard 1" thick disposable filters (not included)
- Removable face for easy installation and cleaning
- Equipped with adjustable filter retainers
- Bright White finish

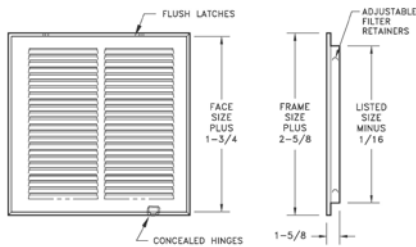

		673 Standard Sizes (in.)											
		WIDTH											
HT		10	12	14	16	18	20	24	25	30	32	36	40
6	X			X				X		X			
8			X				X		X				
10	X						X	X	X	X			
12		X				X	X	X	X	X		X	
14			X				X	X	X	X		X	
16			X	X			X	X	X	X		X	
18		X				X	X	X	X	X			
20	X	X	X	X	X	X	X	X	X	X			X
24		X	X	X	X	X	X	X	X	X		X	
25			X	X			X		X		X		
30		X	X	X			X	X	X	X			
32					X		X		X				
36		X		X			X	X					
40							X						



681/A681 Register

- All-steel construction
- Aluminum face steel damper (A681)
- Used for ceiling or sidewall installations
- Ideal for shallow duct installations
- One-way deflection
- 1/2" spaced fins set at 40 degrees
- Multi-shutter valve
- 1-5/8" depth when fully opened
- Interlocking valve louvers for positive shut-off
- Bright White finish

		681 Available Sizes (in.)						
		WIDTH						
HT		8	10	12	14	16	18	20
4	X							
6	X	X	X	X	X	X	X	X

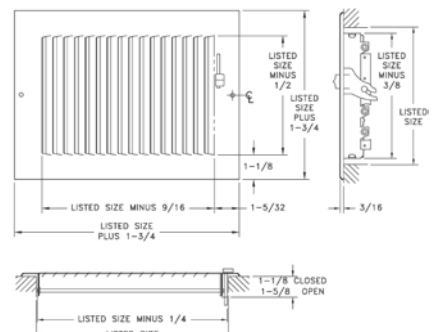

Sidewall Registers & Grilles



682/A682 Register

- All-steel construction
- Aluminum face steel damper (A682)
- Used for ceiling or sidewall installations
- Ideal for shallow duct installations
- Two-way deflection
- 1/2" spaced fins set at 40 degrees
- Multi-shutter valve
- 1-5/8" depth when fully opened
- Interlocking valve louvers for positive shut-off
- Bright White finish

682 Available Sizes (in.)									
HT	WIDTH								
	6	8	10	12	14	16	18	20	24
4	X	X	X	X	X				
5			X	X					
6	X	X	X	X	X	X	X	X	X
8		X	X	X	X	X	X	X	X
10			X						
12				X					

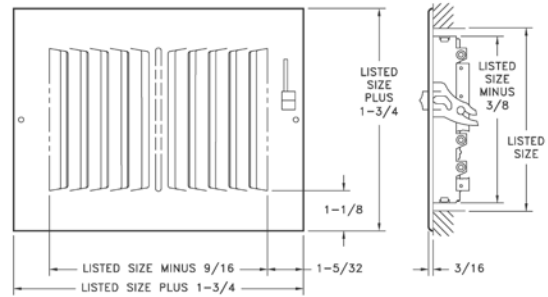

Available with fusible link option, limited sizes (not UL-listed or fire-rated)



683/A683 Register

- All-steel construction
- Aluminum face steel damper (A683)
- Used for ceiling or sidewall installations
- Ideal for shallow duct installations
- Three-way deflection
- 1/2" spaced fins set at 40 degrees
- Multi-shutter valve
- 1-5/8" depth when fully opened
- Interlocking valve louvers for positive shut-off
- Bright White finish

683 Available Sizes (in.)						
HT	WIDTH					
	6	8	10	12	14	16
4		X	X	X	X	
6	X	X	X	X	X	X
8		X	X	X	X	X
10			X			
12				X		
14					X	
16						X

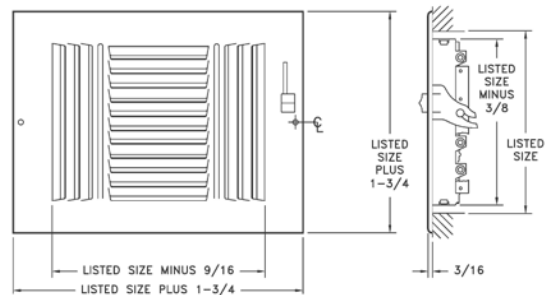

684/A684 Register

- All-steel construction
- Aluminum face steel damper (A684)
- Used for ceiling or sidewall installations
- Ideal for shallow duct installations
- Four-way deflection
- 1/2" spaced fins set at 40 degrees
- Multi-shutter valve
- 1-5/8" depth when fully opened
- Interlocking valve louvers for positive shut-off
- Listed heights 10" and larger require double valves
- Bright White finish

684 Available Sizes (in.)						
HT	WIDTH					
	6	8	10	12	14	16
6	X					
8		X				
10			X			
12				X		
14					X	
16						X

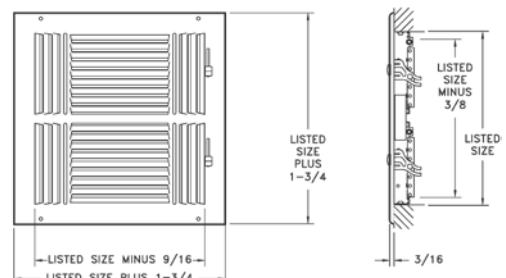



680-OB Series Register

- Fits in a 3-1/2" deep ceiling radiation damper
- Ideal for Multi-Family projects
- Tamper resistant controls
- Equipped with an Opposed Blade Damper
- Available in one, two, three or four way deflection
- All steel construction
- 1/2" spaced fins set at 40 degrees

681-OB										
	6	8	10	12	14	16	18	20	22	24
4	X	X	X	X						
6	X	X	X	X						
8	X	X	X	X						
10		X								
12			X							
14										
16										

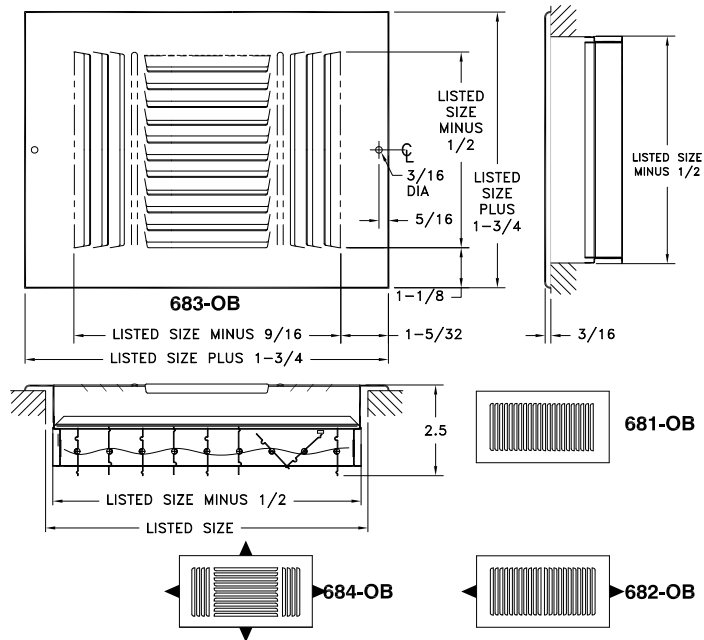

682-OB										
	6	8	10	12	14	16	18	20	22	24
4	X	X	X	X	X	X				
6	X	X	X	X	X	X	X	X		X
8	X	X	X	X		X	X	X		X
10		X		X	X	X				
12				X	X	X				
14										
16										

683-OB										
	6	8	10	12	14	16	18	20	22	24
4	X	X	X	X	X	X				
6	X	X	X	X	X	X	X	X		X
8	X	X	X	X	X	X	X	X		X
10		X		X	X	X				
12				X	X	X	X			
14										
16										

684-OB										
	6	8	10	12	14	16	18	20	22	24
4										
6	X									
8		X								
10			X							
12				X						
14					X					
16						X				

Sidewall Registers & Grilles



680M Series Register

- All-steel construction with metal handle
- Stamped, straight-blade supply register with multi-louver damper for ceiling or sidewall installation
- Stamped, one-piece face with multi-louver damper for volume control
- Fins spaced on 1/2" centers at 40 degrees
- Available in 1-way, 2-way, 3-way and 4-way airflow patterns
- Bright White finish

681M Available Sizes (in.)							
HT	WIDTH						
	8	10	12	14	16	18	20
4	X						
6		X	X	X	X		X
8			X				

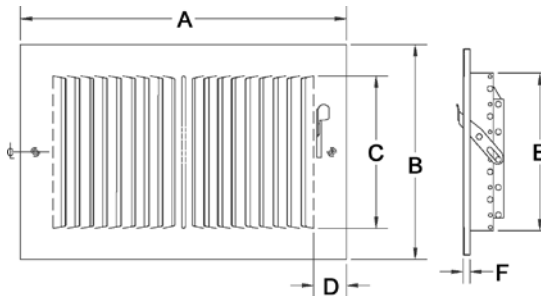

A	B	C	D	E	F
LISTED SIZE PLUS 1-3/4"	LISTED SIZE PLUS 1-3/4"	LISTED SIZE MINUS 5/8"	1-3/16"	LISTED SIZE MINUS 1/4"	5/16"



682M Available Sizes (in.)							
HT	WIDTH						
	6	8	10	12	14	16	
4	X	X	X	X	X	X	
6	X	X	X	X	X	X	X
8		X	X	X	X	X	X
10			X		X		



683M Available Sizes (in.)							
HT	WIDTH						
	6	8	10	12	14	16	
4		X	X	X	X		
6	X	X	X	X	X	X	
8		X	X	X	X	X	
10			X		X		
12				X			



684M Available Sizes (in.)					
HT	WIDTH				
	6	8	10	12	14
6	X				
8		X			
10			X		
12				X	
14					X



A711MS Register

- Aluminum construction
- Used for ceiling or sidewall installations
- One-way deflection
- One-way air pattern
- Adjustable curved blades increase deflection control
- Multi-shutter valve
- Bright White finish

A711 Available Sizes (inches)					
Height	Width				
	6	8	10	12	14
4		X	X		
6	X		X	X	X
8		X	X	X	X
10			X		
12				X	

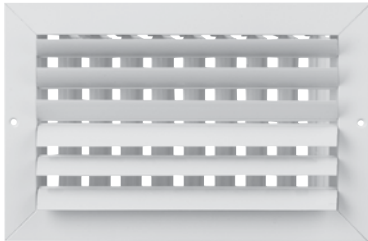

A712MS Register

- Aluminum construction
- Used for ceiling or sidewall installations
- Two-way deflection
- Two-way air pattern
- Adjustable curved blades increase deflection control
- Multi-shutter valve
- Bright White finish

A712 Available Sizes (inches)		
Height	Width	
	10	12
6	X	X
8		X
10	X	
12		X



A713MS Register

- Available in a 10" x 10" size
- Aluminum construction
- Used for ceiling or sidewall installations
- Three-way deflection
- Three-way air pattern
- Adjustable curved blades increase deflection control
- Multi-shutter valve
- Bright White finish

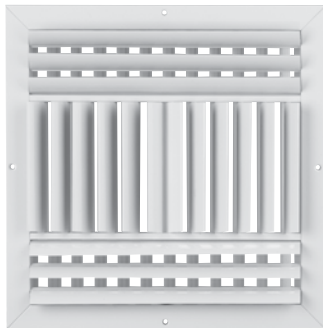

A714MS Register

- Aluminum construction
- Used for ceiling or sidewall installations
- Four-way deflection
- Four-way air pattern
- Adjustable curved blades increase deflection control
- Multi-shutter valve
- Bright White finish

A714 Available Sizes (inches)					
Height	Width				
	6	8	10	12	14
6	X				
8		X			
10			X		
12				X	
14					X

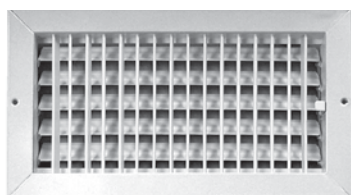

A718MS Register

- Aluminum construction
- Adjustable straight fins provides individual deflection control
- Stamped face margins eliminate mitered corners and rough edges
- Multi-shutter valve
- Bright White finish

A718 Available Sizes (inches)				
Height	Width			
	8	10	12	14
4	X	X	X	X
6		X	X	X
8		X	X	X
10				
12				

Rezzin™ Registers & Diffusers



2-Way Plastic Sidewall/ Ceiling Register

- Engineered polymer construction
- Two-way deflection
- Traditional styling
- Integral multi-shutter damper with easy-to-use damper handle
- For heating or cooling applications
- Bright White finish

2-Way Available Sizes (in.)				
HT	WIDTH			
	4	8	10	12
6	X	X	X	X
8		X		X

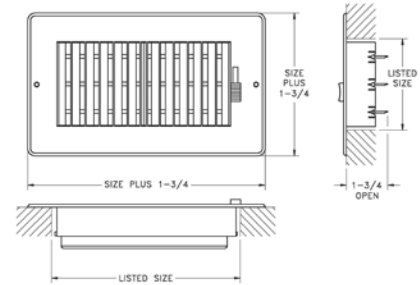

3-Way Plastic Sidewall/ Ceiling Register

- Engineered polymer construction
- Three-way deflection
- Traditional styling
- Integral multi-shutter damper with easy-to-use damper handle
- For heating or cooling applications
- Bright White finish

3-Way Available Sizes (in.)				
HT	WIDTH			
	4	8	10	12
6	X	X	X	X
8		X		X

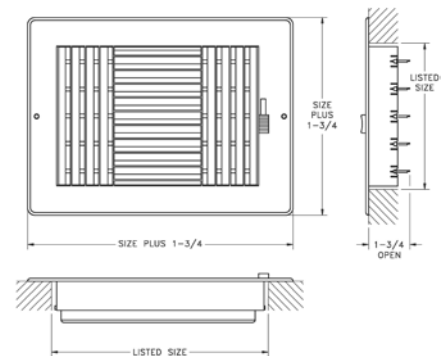

4-Way Plastic Sidewall/Ceiling Register

- Engineered polymer construction
- Four-way deflection
- Traditional styling
- Integral multi-shutter damper with easy-to-use damper handle
- For heating or cooling applications
- Bright White finish

4-Way Available Sizes (in.)				
HT	WIDTH			
	6	6	8	10
8	X	X		
10			X	
12				X

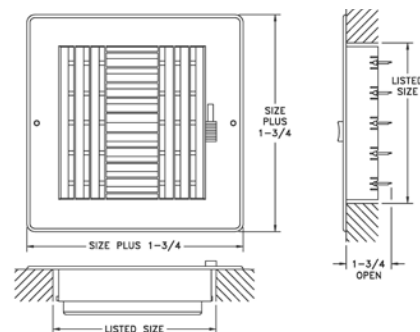



Access Door (HCAD)

- All Steel Construction
- Flush, removable face with concealed latches and Hinges
- 22 gauge face, 24 gauge frame
- Available in bright white finish
- Available in sizes: 6x6, 8x8, 10x10, 12x12, 14x14, 16x16, 24x24

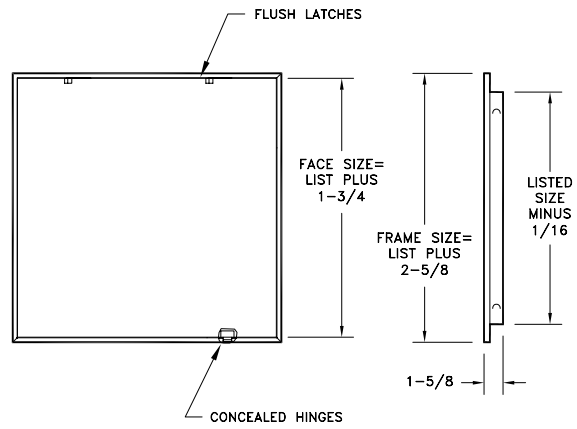

Ceiling Diffusers



16 Ceiling Diffuser

- All-steel construction
- Step-down diffuser rings deflect air stream 360 degrees
- Bright White finish

Only available in sizes shown.

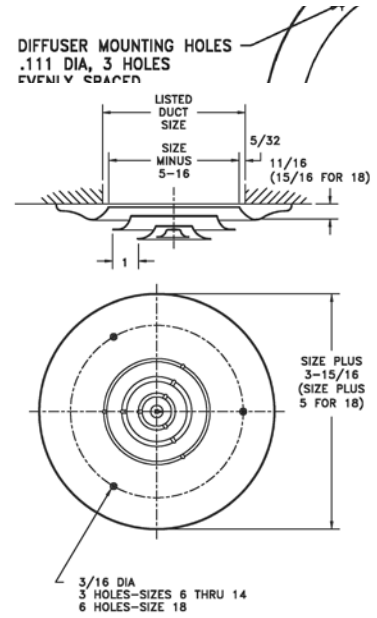

12 Butterfly Damper

- All-steel construction
- Controls air volume evenly over entire #16 diffuser
- Removable knob operator for adjustment from closed to fully open
- Golden Sand enamel finish

Note: Knob permits diffuser to be held in position while attaching face screws.

Only available in sizes shown.

12 Available Sizes (in.)		
Size	A	B
6	7 ¹ / ₂	3 ¹¹ / ₁₆
8	9 ¹ / ₂	4 ¹¹ / ₁₆
10	10 ⁷ / ₈	5 ¹¹ / ₁₆
12	12 ⁷ / ₈	6 ¹¹ / ₁₆
14	14 ⁷ / ₈	7 ¹¹ / ₁₆
18	18 ³ / ₁₆	9 ¹¹ / ₁₆

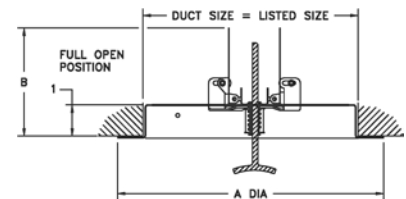

11 Duct Ring

- All-steel construction
- For installation of #16 diffuser when not using a damper
- Golden Sand enamel finish

SURFACE MOUNTING HOLES
.19 DIA, 3 HOLES

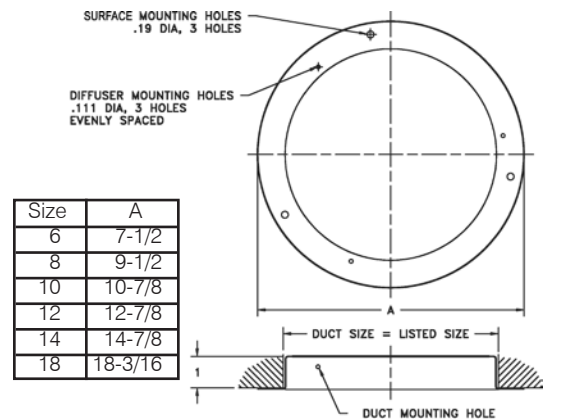

Size	A
6	7-1/2
8	9-1/2
10	10-7/8
12	12-7/8
14	14-7/8
18	18-3/16



24 Square Ceiling Diffuser

- All-steel construction
- Step-down face deflects air stream 360 degrees
- Bright White finish

Only available in sizes shown.

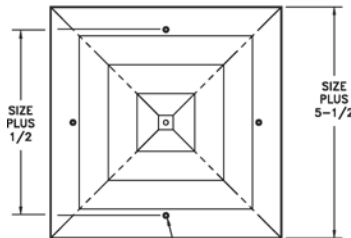
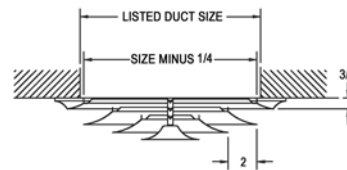

7/32 DIA
2 SCREW HOLES FOR
6 TO 8 INCH SIZES
4 SCREW HOLES FOR
10, 12 AND 14 INCH SIZES

24 Ceiling Diffuser (in.)		
Size	Free Area Sq. Inches	No. of Cones
6	41	3
8	65	3
10	84	3
12	123	4
14	152	4
16	199	5
18	236	5
20	293	6
22	338	6
24	404	7



21 Installation Frame

- All-steel construction
- Golden Sand enamel finish
- Used but not furnished with #24 ceiling diffusers.

Not required when using 22 Butterfly Damper or 23 Opposed Blade Damper.

Cannot be used with SD and SDD.

21 Available Sizes (in.)
6, 8, 10, 12, 14, 16, 18, 20, 22, 24

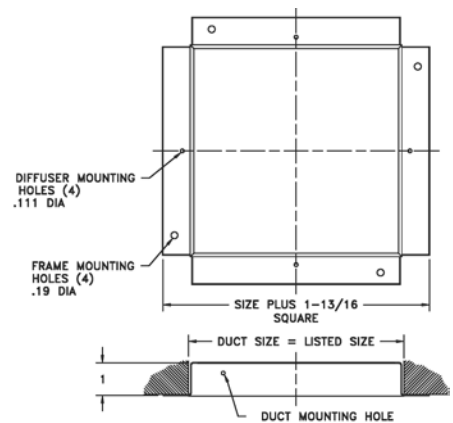

22 Butterfly Damper

- All-steel construction
- Used with #24 Ceiling Diffuser
- Knob control for quick adjustment (removable)
- Installation flange included
- Golden Sand enamel finish

Only available in sizes shown.

22 Available Sizes (in.)		
Size	A	B
6	6 ³ / ₁₆	3 ¹¹ / ₁₆
8	8 ³ / ₁₆	4 ¹¹ / ₁₆
10	10 ³ / ₁₆	5 ¹¹ / ₁₆
12	12 ³ / ₁₆	6 ¹¹ / ₁₆
14	14 ³ / ₁₆	7 ¹¹ / ₁₆

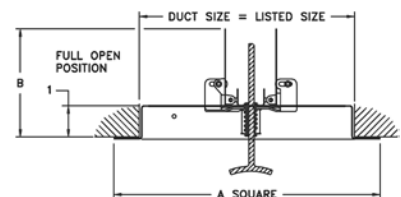

Ceiling Diffusers

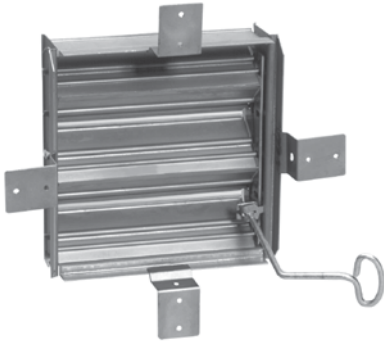

23 Opposed-Blade Damper

- All-steel construction
- Used with #24 Ceiling Diffuser
- Controls air volume over entire diffuser
- Key operated
- Mill finish

23 Available Sizes (in.)	
6	8, 10, 12, 14, 16, 18, 20, 22, 24

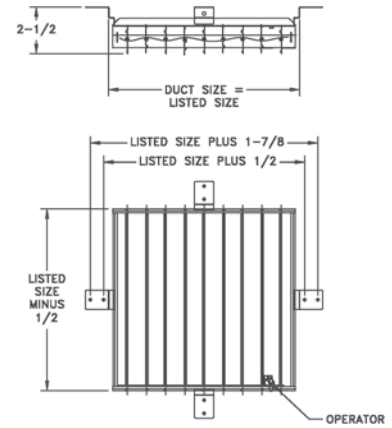

A501MS/A501OB Square Ceiling Diffuser

- Extruded aluminum construction
- Cores flush with margin
- One-way air diffusion
- Face mount for easy installation
- For sidewall or ceiling application
- Multi-shutter or opposed-blade dampers - aluminum
- Inconspicuous fingertip lever for air volume control
- Bright White finish

A501MS/A501OB (in.)					
HT	WIDTH				
		6	8	10	12
6	X				
8		X			
10			X		
12				X	
14					X

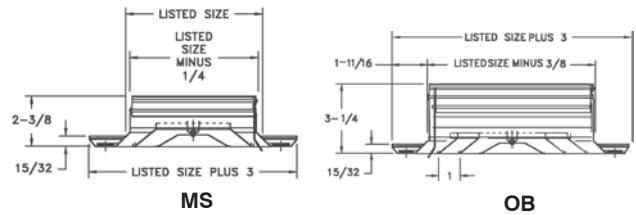

A502MS/A502OB Square Ceiling Diffuser

- Extruded aluminum construction
- Cores flush with margin
- Two-way air diffusion
- Face mount for easy installation
- For sidewall or ceiling application
- Multi-shutter or opposed-blade dampers - aluminum
- Inconspicuous fingertip lever for air volume control
- Bright White

A502MS/A502OB (in.)					
HT	WIDTH				
		6	8	10	12
6	X				
8		X			
10			X		
12				X	
14					X

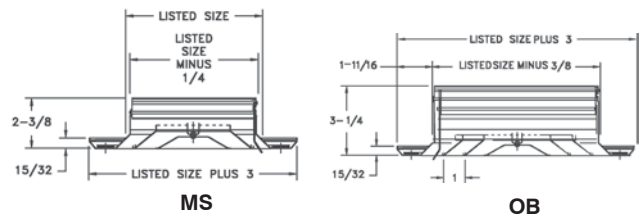



A503MS/A503OB Square Ceiling Diffuser

- Extruded aluminum construction
- Cores flush with margin
- Three-way air diffusion
- Face mount for easy installation
- For sidewall or ceiling application
- Multi-shutter or opposed-blade dampers - aluminum
- Inconspicuous fingertip lever for air volume control
- Bright White finish

A503MS/A503OB (in.)					
HT	WIDTH				
	6	8	10	12	14
6	X				
8		X			
10			X		
12				X	
14					X

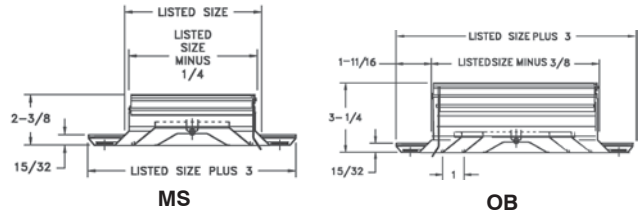

A504MS/A504OB Square Ceiling Diffuser

- Extruded aluminum construction
- Cores flush with margin
- Four-way air diffusion
- Face mount for easy installation
- For sidewall or ceiling application
- Multi-shutter or opposed-blade dampers - aluminum
- Inconspicuous fingertip lever for air volume control
- Bright White finish

A504MS/A504OB (in.)					
HT	WIDTH				
	6	8	10	12	14
6	X				
8		X			
10			X		
12				X	
14					X

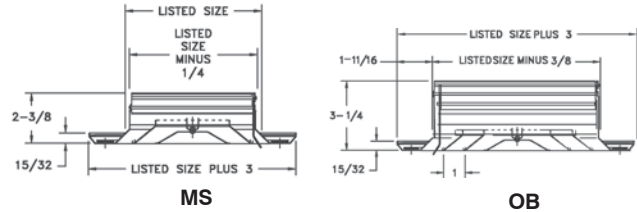

A505MS/A505OB Square Ceiling Diffuser

- Extruded aluminum construction
- Cores flush with margin
- Two-way corner air diffusion
- Face mount for easy installation
- For sidewall or ceiling application
- Multi-shutter or opposed-blade dampers - aluminum
- Inconspicuous fingertip lever for air volume control
- Bright White finish

A505MS/A505OB (in.)					
HT	WIDTH				
	6	8	10	12	14
6	X				
8		X			
10			X		
12				X	
14					X

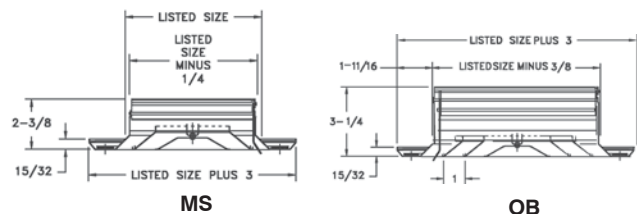

Rezzin™ Registers & Diffusers

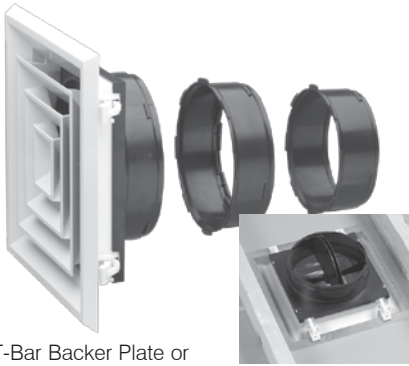

T-Bar Backer Plate or Rafter Rough-In Plate Available

Rezzin Square Ceiling Diffuser

- Engineered polymer construction
- 12"x12" face
- 6", 7" and 8" collars included
- Ratcheting cam lock—install without screws
- Removable core and integral damper
- Available in 4-way, 3-way and 2-way corner
- Bright White finish
- Contains metal parts

Sq Ceiling Available Size (in.)
12 x 12

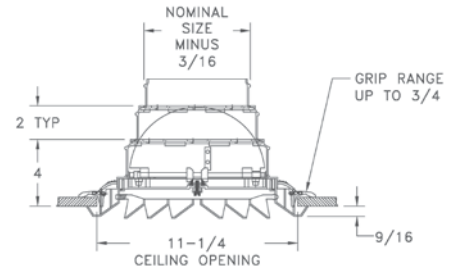

4-WAY



3-Way



4-Way



2-Way Corner

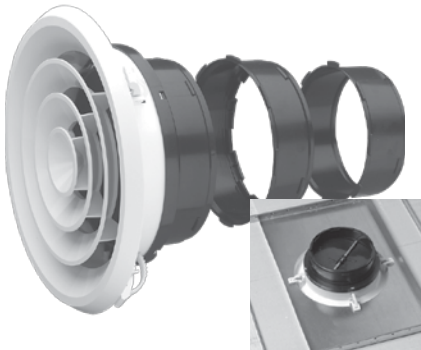

T-Bar Backer Plate or Rafter Rough-In Plate Available

Rezzin Round Ceiling Diffuser

- Engineered polymer construction
- 12" round face
- 6", 7" and 8" collars included
- Ratcheting cam lock—install without screws
- Removable core and integral damper
- Bright White finish
- Contains metal parts

Rd Ceiling Available Size (in.)
12

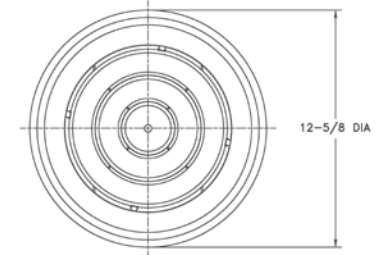
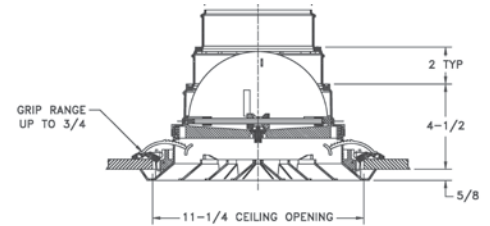

Rezzin Rough-In Plates



16" O.C.



24" O.C.

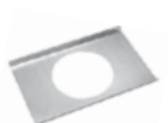

T-Bar



16" O.C.



24" O.C.



T-Bar

Using the Engineering Data

For most of the models & sizes we've done the calculations for you.

421

Face Velocity		300	400	500	600	700	800
Pressure Loss		.006	.010	.016	.022	.031	.040
4x10 Ak .170	CFM	50	70	85	100	120	135
	Spread	4.5	5.0	6.5	7.5	9.0	10.0
	Throw	4.0	6.0	8.0	10.0	11.0	12.5

Terminal velocity of 50 fpm

821-defl A

Face Velocity		400	500	600	700	800
Pressure Loss		.010	.016	.022	.031	.040
24 x 8 Ak 1.045	CFM	420	525	625	730	835
	Throw	17.0	21.0	25.0	29.0	33.0

Terminal velocity is 75 fpm

CFM = volume of air flow in cubic feet per minute

Face Velocity = speed of air at the face of diffuser in feet per minute (FPM)

Ak = net area in square feet. This is the lab measured area across the face when air is mechanically forced through the opening.

Free Area (if given) = daylight area (in²) of blade openings. Free area is typically only required on natural / gravity movement of air, non-mechanically forced, as in free area needed for combustion air requirements on heating equipment. Use the Ak value (*144 to get to in²) if the free area has not been calculated, but is needed for a given size/model grille requiring free area for combustion.

Equation of Airflow: CFM = Ak (ft²) x Face Velocity (fpm)

Example from 421 table above: 100 = .17 x 600 _ numbers are often rounded

Sizing a Supply

Determine the amount of CFM (air volume) needed for each supply outlet. This should be done by room heating and cooling load requirements from various design manuals (ACCA Man J, ASHRAE Fundamentals Hndbk) and then followed by the duct design and layout.

Face Velocity - H&C recommends sizing a supply outlet in the range of 500 to 800 fpm face velocity (700 being a common target). The upper end of this range will create better mixing of room air and longer throws, which is what the typical forced air system is intended to do. However, the Pressure resistance and Noise must be taken into consideration depending upon the applica-

tion. In some instances, greater face velocity is allowed because the pressure and noise can be accommodated.

Pressure Loss (inches of w.c.) – the selection of the face velocity must consider the associated pressure loss that deals with each relative model. An increase in face velocity creates more pressure resistance against the blower's delivery of air volume. The velocity ranges given previously, in most cases, will have minor effect on the blower's overall performance given the entire duct system losses that it will encounter.

Noise – an increase in face velocity will create more noise. The tables below show NC design guidelines and also face velocity ranges if NC values have not been tabulated.

Application	Recommended Face Velocities
Broadcasting Studios	<500 FPM
Residences	500 to 750 FPM
Apartments	500 to 750 FPM
Churches	500 to 750 FPM
Hotel Guestrooms	500 to 750 FPM
Legitimate Theaters	500 to 1000 FPM
Private Offices, acoustically treated	500 to 1000 FPM
Private Offices, not treated	1000 to 1250 FPM
Motion Picture Theaters	1000 to 1250 FPM
General Offices	1250 to 1500 FPM
Stores, upper floors	1500 FPM
Stores, main floors	1500 FPM
Industrial Buildings	1500 to 2000 FPM

	Communication Environment	Typical Occupancy
< NC 25	Extremely quiet environment; suppressed speech is quite audible; suitable for acute pickup of all sounds.	Broadcasting studios, concert halls, music rooms.
NC 30	Very quiet office; suitable for large conferences; telephone use satisfactory.	Residences, theaters, libraries, executive offices, directors rooms.
NC 35	Quiet office; satisfactory for conference at a 15-foot table; normal voice 10 to 30 feet; telephone use satisfactory.	Private offices, schools, hotel guestrooms, courtrooms, churches, hospital rooms.
NC 40	Satisfactory for conferences at a 6- to 8-foot table; normal voice 6 to 12 feet; telephone use satisfactory.	General office, labs, dining rooms.
NC 45	Satisfactory for conferences at a 4- to 5-foot table; normal voice 3 to 6 feet; raised voice 6 to 12 feet; telephone use occasionally difficult.	Retail stores, cafeterias, lobby areas, large drafting and engineering offices, reception areas.
> NC 50	Unsatisfactory for conference of more than two or three persons; normal voice 1 to 2 feet; raised voice 3 to 6 feet; telephone use slightly difficult.	Computer rooms, stenographic pools, print machine rooms, process areas.

Sizing a Return

Air volume going back to the air handler (fan) must equal what is supplied from the air handler. Therefore the total CFM capacity of the return grilles must equal

Engineering Data

or exceed the total CFM capacity of all the supply diffusers.

Keeping face velocity low

- Returns should be at 400-600 fpm maximum
- Filter Returns should be at 450 fpm maximum
- *ACCA recommends 300 max for filter grilles and 500 max for non-filter grilles.
- The rule of thumb is 2 cfm per square inch of filter size. See table below.
- Low velocity reduces noise, especially on stamped face grilles (672/673); fixed-bar grilles can handle more velocity without noise (94A/96AFB/RH45/RHF45/RCB).
- You really can't oversize a single point return like you can with a supply. The system will not be affected adversely, only improved. *This does not apply to multiple return locations where balancing is more critical to pull in relevant amounts from each room.
- Static pressure is also reduced. Pressure works

Filter Size	Area (in ²)	Ton (cfm)	Filter Size	Area (in ²)	Ton (cfm)
12 12	144	n/a	20 20	400	2 (800)
12 20	240	1 (400)	20 25	500	2.5 (1000)
12 24	288	1.5 (600)	20 30	600	3 (1200)
12 30	360	1.5 (600)	20 36	720	3 (1200)
14 14	196	1 (400)	24 24	576	3 (1200)
14 20	280	1.5 (600)	24 30	720	3 (1200)
14 24	336	1.5 (600)	24 36	864	4 (1600)
14 30	420	2 (800)	25 25	625	3 (1200)
16 20	320	1.5 (600)	30 30	900	4 (1600)
16 24	384	2 (800)	30 36	1080	5 (2000)

against & reduces blower delivery volume (cfm)

- No one expects noise from a return.

Location

- Returns should be put in stagnant air locations that need to be reconditioned.
 - High for cooling mode (hot air rises)
 - Low for heating mode (cold air falls)
 - Both modes, choose a primary season
- Returns should not be near a supply register's throw range. If at all possible place the return at an opposite corner of the room.

Room Air Movement

- Returns do NOT have much effect on a room's air movement, regardless of face velocity. They only grab air about a duct diameter away from the face. Most of the room air movement is done by the supplies.

Unlisted Sizes—Engineering Data

When a size is not listed there are a couple ways to do an engineered estimate. Airflow principles permit you to utilize existing sizes to determine sizes not shown.

Method 1: Use nearest nominal size table entry. If a 14x14 is not given, but a 20x10 is, since these two

sizes have an approximate equal core area (196 and 200) the table entry for a 20x10 can be used to approximate what the 14x14 grille would perform to.

Method 2: A more exact method would be to do interpolation process between two listed sizes. If 14x14 is not given, but 18x10 and 20x10 are, then this equation will get more exact 14x14 data. $Y = Y1 + [(X - X1) * (Y2 - Y1)] / (X2 - X1)$ where:

Y = unknown CFM or throw that is being computed for 14x14

Y1 = CFM or throw of listed 18x10 (for ex 600 cfm)

Y2 = CFM or throw of listed 20x10 (for ex 640 cfm)

X = 196 in² (nominal area of 14x14)

X1 = 180 in² (nominal area of 18x10)

X2 = 200 in² (nominal area of 20x10)

Using equation above computes $Y = 600 + [(196 - 180) * (640 - 600)] / (200 - 180) =$

$600 + [(16 * 40) / 20] = 600 + 32 = 632$ cfm for Y

Method 3: Sizes beyond the table (smaller or larger) can have their CFM or Throw determined by using listed sizes by the following:

24		
12 x 6	12 x 6	12
12 x 6	12 x 6	

CFM for larger sizes:

If looking for 24x6 or 24x12 cfm that is not listed, using the listed 12x6 cfm and doubling it or quadrupling it will give the answer for the 24x6 and 24x12, respectively.

CFM for smaller sizes:

If looking for a 6x6 cfm that is not listed, using the listed 12x6 cfm and halving it will give the answer for a 6x6.

Throw:

Double the size and CFM, multiply the throw by 1.5

Quadruple the size and CFM, multiply the throw by 2

Half the size and CFM, multiply the throw by .67

One quarter the size and CFM, multiply the throw by .5

*Pressure loss, face velocity and noise criteria will all remain the same relative to the listed size used to determine the larger or smaller sizes not shown.

210 Floor Register (Page 6)

Face Velocity		300	400	500	600	700	800	900	1000
Pressure Loss		.006	.010	.016	.022	.031	.040	.050	.062
4 x 10	CFM	60	80	100	120	140	160	180	200
Ak .20	Throw	8	11	13	16	19	22	24	26
4 x 12 and 6 x 8	CFM	75	100	125	150	175	200	225	250
Ak .25	Throw	9	12	15	18	21	25	28	31
4 x 14	CFM	85	110	140	170	195	225	250	280
Ak .28	Throw	6	10	15	19	22	25	28	32
6 x 10 and 8 x 8	CFM	95	130	160	190	225	255	290	320
Ak .32	Throw	10	14	17	21	24	27	31	34
6 x 12	CFM	115	150	190	230	265	305	340	380
Ak .38	Throw	12	15	19	23	26	30	34	38
8 x 10	CFM	125	170	210	250	295	335	380	420
Ak .42	Throw	12	15	18	24	28	32	37	41
6 x 14	CFM	130	175	220	265	310	350	395	440
Ak .44	Throw	13	16	20	24	28	32	36	41
6 x 16	CFM	145	195	245	295	345	390	440	490
Ak .49	Throw	11	16	21	25	30	35	39	44
8 x 12 and 10 x 10	CFM	160	210	265	320	370	425	475	530
Ak .53	Throw	12	17	21	26	32	37	43	48
9 x 12 and 8 x 14	CFM	180	240	300	360	420	480	540	600
Ak .60	Throw	14	20	24	29	34	39	44	50
10 x 12	CFM	195	260	325	390	455	520	585	650
Ak .65	Throw	14	18	24	30	35	41	46	51
8 x 16 and 9 x 14	CFM	205	275	345	415	485	550	620	690
Ak .69	Throw	15	21	27	32	37	42	48	53
10 x 14 and 12 x 12	CFM	235	310	390	470	545	625	700	780
Ak .78	Throw	14	21	28	34	40	46	51	56
10 x 16	CFM	265	350	440	530	615	705	790	880
Ak .88	Throw	17	23	30	36	41	48	53	60
12 x 14	CFM	280	370	465	560	650	745	835	930
Ak .93	Throw	18	24	30	37	43	50	56	62
12 x 16 and 14 x 14	CFM	320	430	535	640	750	855	965	1070
Ak 1.07	Throw	20	26	32	39	46	53	59	64
12 x 18 and 14 x 16	CFM	365	490	610	730	855	975	1100	1220
Ak 1.22	Throw	21	28	34	42	49	56	62	68
14 x 18	CFM	425	570	710	850	995	1135	1280	1420
Ak 1.42	Throw	22	30	37	45	52	58	63	68
12 x 24 and 14 x 20	CFM	475	635	795	955	1115	1270	1430	1590
Ak 1.59	Throw	23	31	39	46	52	59	65	71

Terminal Velocity of 50 FPM

411 Floor Diffuser (Page 6)

Face Velocity		300	400	500	600	700	800	900	1000
Pressure Loss		.006	.010	.016	.022	.031	.040	.050	.062
2 1/4 x 10	CFM	25	35	45	55	60	70	80	90
Ak .09	Spread	3.0	4.0	5.0	6.5	7.5	9.0	10.0	11.0
	Throw	2.0	2.5	3.0	4.0	4.5	5.0	6.0	6.5
2 1/4 x 12	CFM	35	45	55	65	75	90	100	110
Ak .11	Spread	3.0	4.5	6.0	7.0	8.5	9.5	11.0	12.0
	Throw	2.0	3.0	3.5	4.0	5.0	6.0	6.5	7.0
2 1/4 x 14	CFM	40	50	65	80	90	105	115	130
Ak .13	Spread	3.5	5.0	7.0	8.0	9.5	10.5	12.0	13.0
	Throw	2.5	3.0	4.0	4.5	5.5	6.5	7.0	8.0
4 x 10	CFM	50	70	85	100	120	135	155	170
Ak .17	Spread	4.0	6.0	7.5	9.0	11.0	12.0	13.5	15.5
	Throw	3.0	3.5	4.5	5.5	6.5	7.0	8.0	9.0
4 x 12	CFM	65	85	105	125	145	170	190	210
Ak .21	Spread	5.0	7.0	8.5	10.0	12.0	13.5	15.5	17.0
	Throw	3.0	4.0	5.0	6.0	7.0	8.0	9.0	10.0
4 x 14	CFM	75	100	125	150	175	200	225	250
Ak .25	Spread	5.5	7.5	9.5	11.0	13.0	15.0	17.0	18.5
	Throw	3.5	4.5	5.5	6.5	7.5	9.0	10.0	11.0
6 x 10	CFM	80	110	135	160	190	215	245	270
Ak .27	Spread	6.0	8.0	10.0	11.5	13.5	15.5	17.5	19.5
	Throw	3.5	4.5	6.0	7.0	8.0	9.0	10.5	11.5
6 x 12	CFM	100	130	165	200	230	265	295	330
Ak .33	Spread	6.5	8.5	11.0	13.0	15.0	17.0	19.5	21.5
	Throw	4.0	5.0	6.5	7.5	9.0	10.0	11.5	12.5
6 x 14	CFM	115	155	195	235	275	310	350	390
Ak .39	Spread	7.5	9.5	12.0	14.0	17.0	19.0	21.5	23.5
	Throw	4.5	5.5	7.0	8.5	10.0	11.0	12.5	14.0

Terminal Velocity of 50 FPM

265 Return Air Grille (Page 6)

Average Face Velocity*		400	500	600	700	800	900	1000
4 x 12	CFM	120	150	175	205	235	265	295
Ak .295	Pt	.011	.017	.024	.033	.043	.054	.065
4 x 14	CFM	135	170	200	235	270	300	335
Ak .335	Pt	.011	.016	.023	.032	.042	.052	.064
6 x 10	CFM	150	185	220	260	295	335	370
Ak .37	Pt	.010	.016	.022	.031	.041	.051	.063
6 x 12	CFM	180	225	265	310	355	400	445
Ak .445	Pt	.010	.015	.021	.030	.039	.049	.060
8 x 10	CFM	195	245	295	345	390	440	490
Ak .49	Pt	.010	.015	.021	.029	.038	.047	.059
6 x 14	CFM	205	255	305	355	410	460	510
Ak .51	Pt	.010	.015	.020	.029	.038	.047	.058
8 x 12	CFM	235	295	350	410	470	525	585
Ak .565	Pt	.009	.014	.020	.028	.036	.046	.057
8 x 14	CFM	270	340	410	475	545	610	680
Ak .68	Pt	.009	.014	.019	.027	.035	.044	.055
10 x 12	CFM	290	360	430	505	575	650	720
Ak .72	Pt	.009	.014	.019	.027	.035	.043	.054
12 x 12 and 6 x 24	CFM	340	425	510	595	680	765	850
Ak .85	Pt	.009	.013	.019	.026	.033	.042	.053
6 x 30	CFM	410	515	620	720	825	925	1030
Ak 1.03	Pt	.008	.012	.018	.024	.032	.040	.049
8 x 24	CFM	445	555	665	775	890	1000	1110
Ak 1.11	Pt	.008	.012	.018	.024	.031	.039	.048
14 x 14	CFM	460	575	690	805	920	1035	1150
Ak 1.15	Pt	.008	.012	.018	.024	.031	.039	.048
8 x 30	CFM	540	675	810	945	1080	1215	1350
Ak 1.35	Pt	.008	.012	.017	.023	.030	.037	.046
14 x 20	CFM	630	790	950	1105	1265	1420	1580
Ak 1.58	Pt	.007	.011	.016	.022	.029	.036	.045
12 x 24	CFM	655	820	985	1150	1310	1475	1690
Ak 1.64	Pt	.007	.011	.016	.022	.029	.036	.044
10 x 30	CFM	670	840	1010	1175	1345	1510	1680
Ak 1.68	Pt	.007	.011	.016	.022	.029	.036	.044
18 x 18	CFM	720	900	1080	1260	1440	1620	1800
Ak 1.80	Pt	.007	.011	.015	.021	.028	.035	.043
14 x 24	CFM	750	935	1120	1310	1495	1685	1870
Ak 1.87	Pt	.007	.011	.015	.021	.028	.035	.043
12 x 30	CFM	800	1000	1200	1400	1600	1800	2000
Ak 2.00	Pt	.007	.011	.015	.021	.027	.034	.042
14 x 30	CFM	940	1175	1410	1645	1880	2115	2350
Ak 2.35	Pt	.007	.010	.015	.020	.026	.033	.040
24 x 24	CFM	1240	1550	1860	2170	2480	2790	3100
Ak 3.10	Pt	.006	.010	.014	.019	.024	.031	.038

For sizes not listed and sizing tips see page(s) 35

*Velocity measured 1" from face

420/421 Floor Diffuser (Page 7)

Face Velocity		300	400	500	600	700	800	900	1000
Pressure Loss		.006	.010	.016	.022	.031	.040	.050	.062
2 x 10 Ak .085	CFM		35	45	50	60	70	75	85
	Spread		3.0	5.0	5.0	6.0	7.0	8.0	9.0
	Throw		4.0	4.5	6.0	7.0	8.0	9.0	10.0
2 x 12 Ak .100	CFM	30	40	50	60	70	80	90	100
	Spread	3.0	4.0	4.5	5.5	6.5	7.0	8.0	9.0
	Throw	3.5	4.5	5.5	7.0	8.0	9.0	10.0	11.0
2 x 14 Ak .115	CFM	35	45	60	70	80	90	105	115
	Spread	3.5	4.0	5.0	7.0	7.0	8.0	9.0	10.0
	Throw	3.5	4.5	6.0	8.0	8.0	9.5	10.5	12.0
4 x 8 Ak .130	CFM	40	50	65	80	90	105	115	130
	Spread	3.0	4.0	5.0	6.5	7.5	8.5	9.5	11.0
	Throw	4.0	4.5	6.0	7.5	8.5	10.0	11.0	13.0
4 x 10 Ak .170	CFM	50	70	85	100	120	135	155	170
	Spread	4.5	5.0	6.5	7.5	9.0	10.0	11.5	13.0
	Throw	4.0	6.0	8.0	10.0	11.0	12.5	14.0	15.5
4 x 12 Ak .195	CFM	60	80	100	120	140	160	175	195
	Spread	5.0	6.5	8.0	9.5	11.5	13.0	14.5	16.0
	Throw	4.0	5.5	7.0	8.0	9.5	11.0	12.0	13.0
4 x 14 Ak .230	CFM	70	90	115	140	160	185	205	230
	Spread	5.5	7.0	8.5	10.0	12.0	13.5	15.5	17.0
	Throw	4.5	5.5	7.0	8.5	10.0	11.5	12.5	14.0
6 x 10 Ak .240	CFM	70	95	120	145	170	190	215	240
	Spread	5.5	7.0	8.0	10.0	12.0	14.0	15.0	17.0
	Throw	4.0	5.5	7.0	8.5	10.0	11.0	12.5	14.0
6 x 12 Ak .285	CFM	85	115	140	170	200	230	255	285
	Spread	6.0	7.5	9.0	11.0	13.0	15.0	17.0	19.0
	Throw	4.5	6.0	7.5	9.0	10.0	12.0	14.0	16.0
6 x 14 Ak .330	CFM	100	130	165	200	230	265	300	330
	Spread	6.5	8.0	9.0	12.0	14.0	16.5	18.0	20.0
	Throw	4.5	6.5	8.0	9.5	11.0	13.0	15.0	17.0

Terminal Velocity of 50 FPM

Rezzin Floor Diffuser (Page 8)

Face Velocity		300	400	500	600	700	800	900	1000
2 x 12 Ak .084	CFM	25	34	42	50	59	67	76	84
	Ps	.01	.02	.03	.05	.06	.08	.10	.12
	Throw	2.0	2.5	3.5	4.0	4.5	5.5	6.0	6.5
	Spread	1.5	2.0	2.5	3.0	3.0	3.5	4.0	4.5
4 x 10 Ak .141	CFM	42	56	71	85	99	113	127	141
	Ps	.02	.02	.03	.04	.06	.07	.09	.11
	Throw	2.0	2.5	3.0	3.5	4.5	5.0	5.5	6.0
	Spread	0.5	1.5	2.5	3.0	4.0	5.0	5.5	6.5
4 x 12 Ak .157	CFM	47	63	79	94	110	126	141	157
	Ps	.02	.03	.04	.05	.07	.09	.11	.13
	Throw	1.5	2.0	2.5	3.0	3.5	4.0	4.5	5.0
	Spread	0.5	1.5	2.5	4.0	5.0	6.0	7.0	8.0

Terminal Velocity of 50 FPM

531 Royale® Floor Register (Page 7)

Face Velocity		300		400		500		600		700		800		900		1000	
Pressure Loss		.006		.010		.016		.022		.031		.040		.050		.062	
		H	C	H	C	H	C	H	C	H	C	H	C	H	C	H	C
2 x 10 Ak .055 Heating Ak .060 Cooling	CFM							35	35	40	40	45	50	55	55	60	60
	Spread							3.5	4.5	5.0	5.0	5.5	6.0	6.5	7.0	7.0	7.0
	Throw							4.0	6.0	5.5	7.5	6.0	8.5	6.5	9.0	10.0	10.0
2 x 12 Ak .067 Heating Ak .074 Cooling	CFM					35	35	40	45	45	50	55	60	60	65	65	75
	Spread					3.5	4.0	4.0	4.5	5.0	5.5	6.0*	6.0*	6.0*	6.0*	6.0*	6.0*
	Throw					4.0	6.0	5.0	6.5	5.5	7.5	6.0	9.0	7.0	10.0	8.0	11.0
2 x 14 Ak .079 Heating Ak .087 Cooling	CFM			30	35	40	45	45	50	55	60	65	70	70	80	80	85
	Spread			3.0	4.0	4.0	4.5	5.0	5.5	6.0*	6.0*	6.0*	6.0*	6.0*	6.0*	6.0*	6.0*
	Throw			3.5	4.5	5.0	6.0	5.5	7.0	6.5	8.5	7.5	10.0	8.0	11.5	8.5	12.5
4 x 10 Ak .115 Heating Ak .125 Cooling	CFM	35	40	45	50	55	65	70	75	80	90	90	100	105	115	115	125
	Spread	3.0	3.5	3.5	4.5	4.5	5.5	5.5	6.0*	6.0*	6.0*	6.0*	6.0*	6.0*	6.0*	6.0*	6.0*
	Throw	3.0	4.5	4.0	6.0	5.5	7.5	6.5	9.5	7.5	10.5	8.5	11.5	9.5	13.5	11.5	15.0
4 x 12 Ak .140 Heating Ak .160 Cooling	CFM	40	50	55	65	70	80	85	95	100	110	115	130	125	145	140	160
	Spread	3.0	4.0	4.0	5.0	5.0	6.0	5.5	6.0*	6.0*	6.0*	6.0*	6.0*	6.0*	6.0*	6.0*	6.0*
	Throw	3.5	5.0	4.5	6.5	6.0	8.5	7.5	10.0	11.0	11.5	11.0	13.0	11.0	15.0	12.0	17.0
4 x 14 Ak .165 Heating Ak .180 Cooling	CFM	50	55	65	70	80	90	100	110	115	125	130	145	150	160	165	180
	Spread	3.5	4.5	4.5	5.0	5.0	6.0*	6.0*	6.0*	6.0*	6.0*	6.0*	6.0*	6.0*	6.0*	6.0*	6.0*
	Throw	4.0	5.5	5.5	7.0	6.5	9.5	8.0	11.0	10.0	12.5	11.0	14.0	12.0	15.5	13.5	17.5
6 x 10 Ak .190 Heating Ak .205 Cooling	CFM	60	60	75	80	95	105	115	125	135	145	150	165	170	185	190	205
	Spread	3.5	4.5	4.5	5.5	5.5	6.0*	6.0*	6.0*	6.0*	6.0*	6.0*	6.0*	6.0*	6.0*	6.0*	6.0*
	Throw	4.5	6.0	5.5	7.5	7.0	9.5	8.5	11.0	10.0	13.0	11.0	15.0	12.5	16.5	14.0	18.5
6 x 12 Ak .225 Heating Ak .250 Cooling	CFM	70	75	90	100	115	125	135	150	160	175	180	200	205	225	225	250
	Spread	4.0	5.0	5.0	6.0*	6.0*	6.0*	6.0*	6.0*	6.0*	6.0*	6.0*	6.0*	6.0*	6.0*	6.0*	6.0*
	Throw	5.0	6.5	6.0	8.5	8.0	10.5	9.0	12.0	11.0	15.0	12.5	16.5	14.0	18.5	16.0	21.0
6 x 14 Ak .265 Heating Ak .300 Cooling	CFM	80	90	105	120	135	150	160	180	185	210	210	240	240	270	265	300
	Spread	4.5	5.0	5.0	6.0*	6.0*	6.0*	6.0*	6.0*	6.0*	6.0*	6.0*	6.0*	6.0*	6.0*	6.0*	6.0*
	Throw	5.0	7.0	7.0	9.5	8.5	11.5	10.0	13.5	12.0	16.0	13.5	18.0	16.0	20.5	17.5	23.5

The spread shown for the heating mode is for a valve setting of 22° left deflection. *The maximum value given for spread for heating is that which occurs at the ceiling height (8 feet). The cooling spread is a straight vertical column of air and is not shown. Throw and spread values are based on a terminal velocity of 50 FPM.

406 18" Baseboard Diffuser (Page 9)

Face Velocity		300	400	500	600	700	800
Pressure Loss		.013	.022	.035	.048	.067	.088
Ak .260	CFM	80	105	130	155	180	210
	Spread	4.5	6.5	7.5	8.5	9.5	11.0
	Throw	5.0	7.0	8.0	9.0	10.0	11.0

Terminal Velocity of 50 FPM

406 15" Baseboard Diffuser (Page 9)

Face Velocity		300	400	500	600	700	800	900	1000
15"	CFM	48	63	79	95	111	127	143	159
	Ps	.005	.009	.014	.020	.027	.035	.044	.053
Throw	50	5.5	7.5	9.0	11.0	13.0	14.5	16.5	18.5
Spread	FPM	5.5	7.5	7.5	11.5	13.5	15.0	17.0	19.0
Throw	100	3.0	3.5	4.5	5.5	6.5	7.5	8.5	9.0
Spread	FPM	3.0	3.5	4.5	5.5	6.5	7.5	9.0	9.5
Throw	150	2.0	2.5	3.0	3.5	4.5	5.0	5.5	6.0
Spread	FPM	2.0	2.5	3.0	3.5	4.5	5.0	5.5	6.0

462 & 464 Baseboard Diffusers (Page 9)

Airflow (CFM)		300	400	500	600	700	800
2 feet 27 sq. in. Ak .187	CFM	55	75	95	110	130	150
	Spread	6.5	7.5	8.0	8.5	9.0	11.0
	Throw	7.0	8.0	9.5	10.5	12.0	13.0
Pressure Loss		.009	.017	.029	.038	.054	.072
4 feet 54 sq. in. Ak .375	CFM	110	150	185	225	260	300
	Spread	12.0	15.0	17.5	19.0	20.0	21.0
	Throw	7.5	9.0	10.0	11.5	12.5	13.5
	Pressure Loss	.031	.058	.090	.124	.178	.224

Terminal Velocity of 50 FPM

654, 655 Baseboard/Sidewall Registers (Page 10)

Face Velocity		300	400	500	600	700	800	900	1000
Pressure Loss		.006	.010	.016	.022	.031	.040	.050	.062
8 x 6 Ak .180	CFM	55	72	90	108	125	145	162	180
	Throw	7.5	10.0	12.5	15.0	17.5	20.5	23.0	25.0
10 x 6 Ak .230	CFM	70	92	115	140	160	185	205	230
	Throw	9.0	11.5	14.5	17.5	20.0	23.0	25.5	29.0
12 x 6 Ak .290	CFM	85	115	145	175	205	230	260	290
	Throw	10.0	13.0	17.0	20.0	23.5	26.5	30.0	33.0
14 x 6 Ak .340	CFM	102	135	170	205	240	270	305	340
	Throw	11.0	14.5	18.0	22.0	25.5	29.0	32.5	36.0

Terminal Velocity of 75 FPM

664 Baseboard Register (Page 11)

Face Velocity		300	400	500	600	700	800	900	1000
Pressure Loss		.006	.010	.016	.022	.031	.040	.050	.062
8 x 6 Ak .180	CFM	55	70	90	110	125	145	160	180
	Throw	5.5	7.0	9.0	10.5	12.5	14.0	16.0	18.0
10 x 6 and 12 x 5 Ak .245	CFM	75	100	125	145	170	195	220	245
	Throw	6.0	8.0	10.0	12.0	14.0	16.0	18.0	20.0
14 x 6 Ak .360	CFM	110	145	180	215	252	290	325	360
	Throw	7.0	9.5	12.0	14.0	16.5	19.0	21.5	24.0
12 x 8 Ak .425	CFM	130	170	215	255	300	340	385	425
	Throw	7.5	10.0	12.5	15.0	18.0	20.5	23.0	25.5

Terminal Velocity of 75 FPM

657/658 Baseboard Return Grille (Page 10, 11)

Average Face Velocity*		300	400	500	600	700
10 x 6 Ak .38	CFM	115	150	190	225	265
	Pt	.013	.023	.037	.052	.072
12 x 6 Ak .46	CFM	135	180	230	280	320
	Pt	.013	.022	.035	.051	.070
10 x 8 Ak .51	CFM	150	205	255	305	355
	Pt	.012	.022	.035	.050	.068
14 x 6 Ak .53	CFM	160	210	265	320	370
	Pt	.012	.022	.035	.050	.068
12 x 8 Ak .61	CFM	180	245	305	365	430
	Pt	.012	.022	.034	.049	.066
14 x 8 Ak .72	CFM	215	288	360	430	505
	Pt	.012	.021	.033	.047	.065
20 x 6 Ak .75	CFM	225	300	375	450	525
	Pt	.012	.021	.033	.047	.064
16 x 8 Ak .83	CFM	250	330	415	500	580
	Pt	.012	.021	.033	.046	.063
14 x 10 and 24 x 6 Ak .92	CFM	275	365	460	550	640
	Pt	.011	.020	.032	.045	.062
14 x 12 Ak 1.08	CFM	320	430	540	650	755
	Pt	.011	.020	.031	.045	.060
30 x 6 Ak 1.12	CFM	335	445	560	670	780
	Pt	.011	.020	.031	.044	.060
24 x 8 Ak 1.21	CFM	365	485	605	730	850
	Pt	.011	.020	.031	.044	.059
20 x 10 Ak 1.25	CFM	375	500	630	750	880
	Pt	.011	.019	.030	.043	.059
24 x 10 and 30 x 8 Ak 1.50	CFM	450	600	750	890	1040
	Pt	.011	.019	.030	.042	.057
24 x 12 Ak 1.82	CFM	550	730	910	1100	1270
	Pt	.010	.018	.029	.041	.056
30 x 10 Ak 1.91	CFM	575	760	960	1150	1330
	Pt	.010	.018	.029	.041	.055
30 x 12 Ak 2.25	CFM	680	900	1130	1350	1570
	Pt	.010	.018	.028	.040	.054

*Velocity measured 1" from face

301 Curved-Blade Register (Page 12)

Face Velocity		300	400	500	600	700	800	900	1000
6 x 6 Ak .09	CFM	30	40	45	55	65	75	85	95
	Ps	.007	.013	.020	.029	.040	.052	.066	.081
	Throw	6.0	8.0	10.0	11.0	13.0	15.0	17.0	19.0
8 x 4 Ak .11	CFM	30	45	55	65	75	85	95	105
	Ps	.007	.013	.021	.030	.041	.053	.067	.083
	Throw	6.0	8.0	10.0	12.0	14.0	16.0	18.0	20.0
8 x 6 Ak .12	CFM	35	50	60	75	85	100	110	125
	Ps	.007	.013	.021	.030	.040	.053	.067	.082
	Throw	7.0	9.0	11.0	13.0	15.0	17.0	19.0	22.0
8 x 8 Ak .16	CFM	50	65	80	95	110	130	145	160
	Ps	.008	.014	.022	.031	.042	.055	.070	.086
	Throw	8.0	10.0	12.0	15.0	17.0	20.0	22.0	25.0
10 x 4 Ak .12	CFM	35	50	60	70	85	95	110	120
	Ps	.008	.013	.021	.030	.041	.054	.068	.084
	Throw	6.0	9.0	11.0	13.0	15.0	17.0	19.0	21.0
10 x 6 Ak .14	CFM	40	55	70	80	95	110	120	135
	Ps	.008	.014	.021	.031	.042	.054	.069	.085
	Throw	7.0	9.0	11.0	14.0	16.0	18.0	20.0	23.0
10 x 8 Ak .19	CFM	55	75	95	115	130	150	170	190
	Ps	.008	.014	.022	.031	.043	.056	.071	.087
	Throw	8.0	11.0	13.0	16.0	19.0	21.0	24.0	27.0
10 x 10 Ak .24	CFM	70	95	120	145	170	190	215	240
	Ps	.008	.014	.021	.030	.042	.054	.069	.085
	Throw	8.0	11.0	14.0	16.0	19.0	22.0	24.0	27.0
12 x 4 Ak .13	CFM	40	55	65	80	95	105	120	135
	Ps	.008	.014	.021	.031	.042	.054	.069	.085
	Throw	9.0	12.0	15.0	18.0	21.0	24.0	27.0	30.0
12 x 6 Ak .18	CFM	55	75	95	110	130	150	165	185
	Ps	.008	.015	.023	.033	.045	.059	.074	.091
	Throw	7.0	9.0	11.0	13.0	16.0	18.0	20.0	22.0
12 x 8 Ak .22	CFM	65	85	110	130	150	170	195	215
	Ps	.008	.014	.022	.032	.043	.056	.071	.088
	Throw	8.0	11.0	13.0	16.0	19.0	21.0	24.0	26.0
12 x 12 Ak .30	CFM	90	120	150	180	210	235	265	295
	Ps	.008	.014	.022	.032	.044	.057	.073	.090
	Throw	10.0	13.0	16.0	19.0	22.0	25.0	28.0	31.0
14 x 4 Ak .15	CFM	45	60	75	90	105	120	130	145
	Ps	.008	.014	.021	.031	.042	.055	.069	.086
	Throw	10.0	14.0	17.0	20.0	24.0	27.0	30.0	34.0
14 x 6 Ak .22	CFM	65	85	110	130	150	175	195	215
	Ps	.008	.014	.022	.031	.042	.055	.070	.087
	Throw	7.0	9.0	12.0	14.0	16.0	19.0	21.0	23.0
14 x 8 Ak .24	CFM	75	95	120	145	170	195	220	240
	Ps	.008	.014	.022	.032	.043	.057	.072	.089
	Throw	9.0	12.0	14.0	17.0	20.0	23.0	26.0	29.0

Terminal Velocity of 75 FPM

302 Curved-Blade Register (Page 12)

Face Velocity		300	400	500	600	700	800	900	1000
8 x 4 Ak .11	CFM	30	40	50	65	75	85	95	105
	Ps	.012	.021	.033	.047	.064	.083	.106	.131
	Throw	3.0	4.0	6.0	7.0	8.0	9.0	10.0	11.0
8 x 6 Ak .13	CFM	40	50	65	75	90	100	115	125
	Ps	.012	.020	.032	.046	.063	.082	.104	.128
	Throw	4.0	5.0	6.0	7.0	8.0	9.0	11.0	12.0
8 x 8 Ak .19	CFM	55	75	90	110	130	150	165	185
	Ps	.011	.020	.031	.045	.061	.080	.101	.125
	Throw	5.0	6.0	7.0	9.0	10.0	11.0	13.0	14.0
10 x 6 Ak .17	CFM	50	65	85	100	115	130	150	165
	Ps	.011	.020	.031	.045	.062	.080	.102	.126
	Throw	4.0	6.0	7.0	8.0	9.0	11.0	12.0	13.0
10 x 8 Ak .23	CFM	65	90	110	135	155	180	200	225
	Ps	.011	.020	.031	.044	.061	.079	.100	.124
	Throw	5.0	7.0	8.0	10.0	11.0	13.0	14.0	15.0
12 x 6 Ak .21	CFM	60	80	100	125	145	165	185	205
	Ps	.011	.020	.031	.045	.061	.079	.101	.124
	Throw	5.0	6.0	8.0	9.0	10.0	12.0	13.0	15.0
12 x 8 Ak .27	CFM	80	105	130	160	185	210	240	265
	Ps	.011	.020	.031	.044	.060	.079	.099	.123
	Throw	5.0	7.0	9.0	10.0	12.0	14.0	15.0	17.0
14 x 6 Ak .24	CFM	70	95	115	140	165	190	210	235
	Ps	.011	.020	.031	.044	.060	.079	.100	.123
	Throw	5.0	7.0	8.0	10.0	11.0	13.0	14.0	16.0
14 x 8 Ak .31	CFM	90	120	150	185	215	245	275	305
	Ps	.011	.020	.031	.044	.060	.078	.099	.122
	Throw	6.0	8.0	9.0	11.0	13.0	14.0	16.0	18.0

Terminal Velocity of 75 FPM

303 Curved-Blade Register (Page 13)

Face Velocity		300	400	500	600	700	800	900	1000
6 x 6 Ak .12	CFM	35	50	60	75	85	100	110	125
	Ps	.014	.025	.039	.056	.077	.100	.126	.156
	Throw	5.0	7.0	9.0	10.0	12.0	14.0	15.0	17.0
8 x 4 Ak .10	CFM	30	40	50	65	75	85	95	105
	Ps	.015	.027	.041	.060	.081	.106	.134	.166
	Throw	5.0	6.0	8.0	9.0	11.0	12.0	14.0	15.0
8 x 6 Ak .14	CFM	40	55	70	85	100	115	125	140
	Ps	.015	.026	.041	.059	.080	.104	.132	.163
	Throw	6.0	7.0	9.0	11.0	13.0	15.0	16.0	18.0
8 x 8 Ak .18	CFM	55	75	90	110	130	145	165	185
	Ps	.013	.022	.035	.050	.069	.090	.114	.140
	Throw	6.0	8.0	11.0	13.0	15.0	17.0	19.0	21.0
10 x 4 Ak .12	CFM	35	50	60	75	85	100	110	125
	Ps	.014	.025	.039	.056	.076	.100	.126	.156
	Throw	5.0	7.0	9.0	10.0	12.0	14.0	15.0	17.0
10 x 6 Ak .17	CFM	50	70	85	105	120	140	155	175
	Ps	.015	.027	.043	.062	.084	.110	.139	.171
	Throw	6.0	8.0	10.0	12.0	14.0	16.0	18.0	20.0
10 x 8 Ak .22	CFM	65	90	110	135	155	180	200	225
	Ps	.012	.022	.034	.049	.066	.086	.109	.135
	Throw	7.0	9.0	12.0	14.0	16.0	18.0	21.0	23.0
10 x 10 Ak .31	CFM	95	125	155	185	220	250	280	310
	Ps	.015	.027	.043	.062	.084	.110	.139	.172
	Throw	8.0	11.0	14.0	16.0	19.0	22.0	24.0	27.0
12 x 6 Ak .21	CFM	60	85	105	125	145	165	185	205
	Ps	.012	.022	.034	.049	.066	.086	.109	.135
	Throw	7.0	9.0	11.0	13.0	15.0	18.0	20.0	22.0
12 x 8 Ak .26	CFM	80	105	130	160	185	210	240	265
	Ps	.008	.014	.022	.032	.044	.057	.072	.089
	Throw	8.0	10.0	13.0	15.0	17.0	20.0	22.0	25.0
12 x 12 Ak .38	CFM	115	155	190	230	270	305	345	385
	Ps	.008	.014	.023	.033	.044	.058	.073	.090
	Throw	9.0	12.0	15.0	18.0	21.0	24.0	27.0	30.0
14 x 4 Ak .16	CFM	50	65	80	100	115	130	150	165
	Ps	.008	.014	.022	.031	.042	.055	.070	.086
	Throw	6.0	8.0	10.0	12.0	14.0	16.0	17.0	19.0
14 x 6 Ak .20	CFM	60	80	100	120	145	165	185	205
	Ps	.009	.017	.026	.037	.051	.066	.084	.104
	Throw	7.0	9.0	11.0	13.0	15.0	17.0	20.0	22.0
14 x 8 Ak .30	CFM	90	120	150	185	215	245	275	305
	Ps	.008	.014	.022	.032	.044	.057	.073	.090
	Throw	8.0	11.0	13.0	16.0	19.0	21.0	24.0	27.0
16 x 6 Ak .26	CFM	80	105	130	160	185	210	240	265
	Ps	.008	.014	.022	.032	.044	.057	.072	.089
	Throw	8.0	10.0	12.0	15.0	17.0	20.0	22.0	25.0

Terminal Velocity of 75 FPM

304 Curved-Blade Register (Page 14)

Face Velocity		300	400	500	600	700	800	900	1000
6 x 6 Ak .16	CFM	50	65	80	95	110	125	145	160
	Ps	.040	0.72	.112	.161	.219	.287	.363	.448
	Throw	3.0	4.0	5.0	6.0	7.0	8.0	9.0	10.0
8 x 8 Ak .22	CFM	65							

A611 1-Way Adjustable Curved-Blade Register
(Page 16)

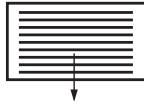

Face Velocity		300	400	500	600	700	800	900	1000	1100	1200
Pressure Loss		.006	.010	.016	.022	.031	.040	.050	.062	.075	.090
8 x 4	CFM	30	45	55	65	75	85	95	105	120	130
Ak .107	Throw	3.5	5.5	6.5	7.5	9.0	10.0	11.5	12.5	14.0	15.5
10 x 4	CFM	40	55	65	80	90	105	120	130	145	160
Ak .132	Throw	4.0	6.0	7.0	8.5	9.5	11.0	12.5	13.5	15.5	17.0
10 x 6	CFM	60	80	100	120	140	160	180	200	220	240
Ak .200	Throw	5.0	6.5	8.5	10.0	11.5	13.5	15.0	16.0	18.0	20.0
12 x 6	CFM	70	95	120	140	165	190	210	235	260	280
Ak .235	Throw	5.5	7.0	9.0	10.5	12.5	14.5	16.0	18.0	20.0	22.0
10 x 8	CFM	80	105	130	160	185	210	240	265	290	315
Ak .264	Throw	5.5	7.5	9.5	11.5	13.0	15.0	17.0	19.0	21.0	23.0
12 x 8	CFM	95	130	160	190	225	255	290	320	350	385
Ak .320	Throw	6.0	8.5	10.5	12.5	14.5	16.5	19.0	21.0	23.0	25.0
14 x 8	CFM	110	145	180	220	255	290	330	365	400	435
Ak .364	Throw	6.5	8.5	11.0	13.0	15.5	17.5	20.0	22.0	24.0	26.0

For sizes not listed and sizing tips see page 40

Terminal Velocity of 75 FPM

A612 2-Way Adjustable Curved-Blade Register
(Page 16)

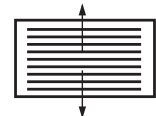

Face Velocity		300	400	500	600	700	800	900	1000	1100	1200
Pressure Loss		.006	.010	.016	.022	.031	.040	.050	.062	.075	.090
10 x 6	CFM	60	80	100	120	140	160	180	200	220	240
Ak .200	Throw	3.5	4.5	6.0	7.0	8.5	9.5	10.5	12.0	13.0	14.0
12 x 6	CFM	70	95	120	140	165	190	210	235	260	280
Ak .235	Throw	4.0	5.0	6.5	7.5	9.0	10.0	11.5	12.5	14.0	15.0
12 x 8	CFM	95	130	160	190	225	255	290	320	350	385
Ak .320	Throw	4.5	6.0	7.5	8.5	10.5	11.5	13.5	14.5	16.0	18.0
14 x 8	CFM	110	145	180	220	255	290	330	365	400	435
Ak .364	Throw	4.5	6.0	7.5	9.5	11.0	12.5	14.0	15.5	17.0	19.0

For sizes not listed and sizing tips see page 40

Terminal Velocity of 75 FPM

A613 3-Way Adjustable Curved-Blade Register
(Page 16)

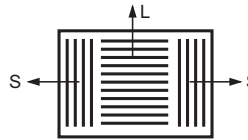

Face Velocity		300	400	500	600	700	800	900	1000	1100	1200
Pressure Loss		.006	.010	.016	.022	.031	.040	.050	.062	.075	.090
10 x 6	Total CFM	60	80	100	120	140	160	180	200	220	240
Ak .200	CFM L/S	22/19	29/26	36/32	43/38	50/45	58/51	65/58	72/64	79/70	86/77
	Throw L/S	3.0/2.0	4.0/4.0	5.0/4.5	6.0/5.0	7.0/6.5	8.0/7.5	9.0/8.5	10.0/9.5	11.0/10.5	12.0/11.5
8 x 8	Total CFM	65	85	110	130	150	170	195	215	235	260
Ak .215	CFM L/S	30/18	39/23	50/30	60/35	68/41	78/46	89/53	98/58	108/64	119/70
	Throw L/S	3.5/3.0	4.5/3.5	6.0/4.5	7.0/5.5	8.0/6.5	9.5/7.0	10.5/8.0	11.5/9.0	13.0/10.0	14.0/11.0
12 x 6	Total CFM	70	95	120	140	165	190	210	235	260	280
Ak .235	CFM L/S	21/25	28/33	36/42	42/49	49/58	57/67	63/74	70/82	77/91	83/98
	Throw L/S	3.0/3.0	4.0/4.0	5.0/5.5	6.0/6.5	7.0/7.5	8.0/8.5	9.0/9.5	9.5/10.5	10.5/11.5	11.5/12.5
10 x 10	Total CFM	100	130	165	200	230	265	295	330	365	395
Ak .330	CFM L/S	36/32	47/42	59/63	72/64	83/74	95/85	106/94	119/106	131/117	142/126
	Throw L/S	4.0/3.5	5.0/4.5	6.5/6.0	7.5/7.0	9.0/8.5	10.0/9.5	11.0/10.5	12.5/12.0	14.0/13.0	15.0/14.0

For sizes not listed or sizing tips see page 35

Terminal Velocity of 75 FPM

A614 4-Way Adjustable Curved-Blade Register
(Page 17)

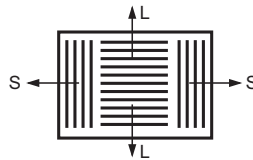

Face Velocity		300	400	500	600	700	800	900	1000	1100	1200
Pressure Loss		.006	.010	.016	.022	.031	.040	.050	.062	.075	.090
8 x 8	Total CFM	65	85	110	130	150	170	195	215	235	260
Ak .215	CFM L/S	15/18	20/23	25/30	30/35	35/41	39/46	45/53	49/58	54/64	60/70
	Throw L/S	2.5/3.0	3.5/3.5	4.0/4.5	5.0/5.5	6.0/6.5	6.5/7.0	7.5/8.0	8.0/9.0	9.0/10.0	10.0/11.0
10 x 10	Total CFM	100	130	165	200	230	265	295	330	365	395
Ak .330	CFM L/S	18/32	24/42	30/53	36/64	42/74	48/85	53/94	60/106	66/117	71/126
	Throw L/S	2.5/3.5	3.5/4.5	4.5/6.0	5.5/7.0	6.5/8.5	7.0/9.5	8.0/10.5	9.0/12.0	10.0/13.0	10.5/14.0
12 x 12	Total CFM	135	180	225	270	315	360	405	450	495	540
Ak .452	CFM L/S	20/47	27/63	34/79	40/95	47/111	54/126	61/142	67/158	74/174	81/190
	Throw L/S	2.5/4.0	3.5/5.5	4.5/7.0	5.5/8.5	6.5/10.0	7.5/11.0	8.5/12.5	9.0/14.0	10.0/15.5	11.0/17.0

For sizes not listed or sizing tips see page 35

Terminal Velocity of 75 FPM

A618 Adjustable Fin Register

(Page 17)
Deflection A

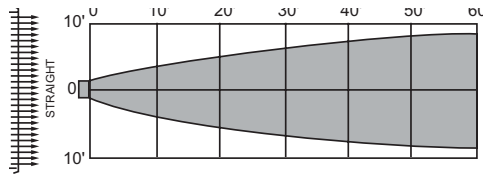

Face Velocity	300	400	500	600	700	800	900	1000	1100	1200
Pressure Loss	.006	.010	.016	.022	.031	.040	.050	.062	.075	.090
8 x 4 CFM	45	60	80	95	110	125	140	155	170	185
Ak_156 Throw	5.0	6.5	8.5	10.0	12.0	13.0	15.0	16.0	18.0	19.0
10 x 4 CFM	60	80	100	120	140	160	180	200	220	240
Ak_198 Throw	6.0	7.5	9.5	12.0	13.0	15.0	17.0	19.0	20.0	22.0
12 x 4 CFM	70	95	120	145	170	190	215	240	265	290
Ak_240 Throw	6.0	8.0	10.0	12.0	14.0	16.0	18.0	20.0	22.0	25.0
10 x 6 CFM	95	125	155	190	220	250	280	315	345	375
Ak_313 Throw	7.0	9.0	12.0	14.0	16.0	19.0	21.0	23.0	26.0	28.0
12 x 6 CFM	115	150	190	225	265	305	340	380	415	455
Ak_379 Throw	8.0	10.0	13.0	15.0	18.0	21.0	23.0	26.0	28.0	31.0
10 x 8 CFM	130	170	215	255	300	340	385	425	470	510
Ak_425 Throw	8.0	11.0	14.0	16.0	19.0	21.0	24.0	27.0	30.0	32.0
14 x 6 CFM	135	180	225	270	310	355	400	445	490	545
Ak_446 Throw	8.0	11.0	14.0	17.0	19.0	22.0	25.0	28.0	30.0	33.0
12 x 8 CFM	160	200	265	320	370	425	475	530	585	635
Ak_530 Throw	9.0	11.0	15.0	18.0	21.0	24.0	27.0	30.0	33.0	36.0
14 x 8 CFM	185	250	310	370	435	495	560	620	680	745
Ak_620 Throw	10.0	13.0	16.0	20.0	23.0	26.0	30.0	33.0	36.0	39.0

For sizes not listed or sizing tips see page 35

Terminal Velocity of 75 FPM

A618 Adjustable Fin Register

(Page 17)
Deflection C

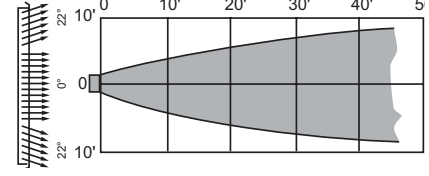

Face Velocity	300	400	500	600	700	800	900	1000	1100	1200
Pressure Loss	.006	.010	.016	.022	.031	.040	.050	.062	.075	.090
8 x 4 CFM	40	55	70	85	100	115	125	140	155	170
Ak_141 Throw	3.5	5.0	6.5	7.5	9.0	10.0	11.0	13.0	14.0	15.0
10 x 4 CFM	55	70	90	105	125	140	160	180	195	215
Ak_178 Throw	4.0	5.5	7.0	8.5	10.0	11.0	13.0	14.0	16.0	17.0
12 x 4 CFM	65	85	110	130	150	175	195	215	240	260
Ak_216 Throw	4.5	6.0	8.0	9.5	11.0	13.0	14.0	16.0	18.0	19.0
10 x 6 CFM	85	115	140	170	195	225	255	280	310	340
Ak_282 Throw	5.5	7.5	9.0	11.0	12.0	14.0	16.0	18.0	20.0	22.0
12 x 6 CFM	105	135	170	205	240	275	310	340	375	410
Ak_342 Throw	6.0	8.0	10.0	12.0	14.0	16.0	18.0	20.0	22.0	24.0
10 x 8 CFM	115	155	195	235	275	310	350	390	430	470
Ak_390 Throw	6.0	8.0	11.0	13.0	15.0	17.0	19.0	21.0	23.0	26.0
14 x 6 CFM	125	165	205	245	290	330	370	410	455	495
Ak_412 Throw	7.0	9.0	11.0	13.0	16.0	18.0	20.0	22.0	24.0	27.0
12 x 8 CFM	140	190	235	280	330	375	425	470	515	565
Ak_470 Throw	7.0	9.0	12.0	14.0	16.0	19.0	21.0	23.0	25.0	28.0
14 x 8 CFM	165	220	275	330	385	440	495	550	605	660
Ak_550 Throw	8.0	10.0	13.0	15.0	18.0	20.0	23.0	25.0	28.0	30.0

For sizes not listed or sizing tips see page 35

Terminal Velocity of 75 FPM

A618 Adjustable Fin Register

(Page 17)
Deflection E

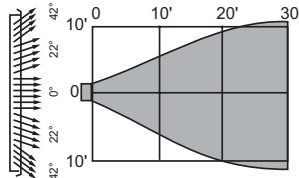

Face Velocity	300	400	500	600	700	800	900	1000	1100	1200
Pressure Loss	.006	.010	.016	.022	.031	.040	.050	.062	.075	.090
8 x 4 CFM	40	50	65	75	90	100	115	125	140	150
Ak_127 Throw	3.0	4.0	5.0	5.5	7.0	7.5	8.5	9.5	11.0	11.5
10 x 4 CFM	50	65	80	95	115	130	145	160	180	195
Ak_162 Throw	3.0	4.5	5.5	6.5	7.5	8.5	9.5	11.0	12.0	13.0
12 x 4 CFM	60	80	100	120	140	160	175	195	215	235
Ak_197 Throw	4.0	4.5	6.0	7.5	8.5	10.0	11.0	12.0	13.0	14.0
10 x 6 CFM	75	105	130	155	180	205	230	255	285	310
Ak_257 Throw	4.0	5.5	7.5	8.5	9.5	11.0	12.0	14.0	15.0	17.0
12 x 6 CFM	95	125	155	185	220	250	280	310	340	375
Ak_311 Throw	4.5	6.0	7.5	9.0	11.0	12.0	14.0	15.0	17.0	18.0
10 x 8 CFM	105	140	175	210	245	280	315	350	385	420
Ak_350 Throw	5.0	6.0	8.0	10.0	11.0	13.0	14.0	16.0	18.0	19.0
14 x 6 CFM	110	145	185	220	255	290	330	365	400	440
Ak_365 Throw	5.5	6.5	8.5	10.0	11.0	13.0	15.0	16.0	18.0	20.0
12 x 8 CFM	130	175	220	260	305	350	390	435	480	520
Ak_435 Throw	5.0	7.0	9.0	11.0	13.0	15.0	16.0	18.0	20.0	22.0
14 x 8 CFM	155	205	255	305	355	410	460	510	560	610
Ak_510 Throw	6.0	8.0	10.0	12.0	14.0	16.0	18.0	20.0	22.0	23.0

For sizes not listed or sizing tips see page 35

Terminal Velocity of 75 FPM

A618 Adjustable Fin Register

(Page 17)
Deflection G

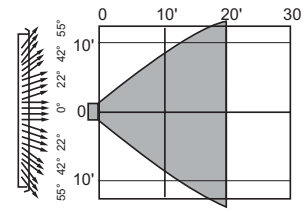

Face Velocity	300	400	500	600	700	800	900	1000	1100	1200
Pressure Loss	.006	.010	.016	.022	.031	.040	.050	.062	.075	.090
8 x 4 CFM	35	45	60	70	85	95	105	120	130	140
Ak_118 Throw	2.0	2.5	3.5	4.0	5.0	5.5	6.0	6.5	7.5	8.0
10 x 4 CFM	45	60	75	90	105	120	135	150	165	180
Ak_149 Throw	2.0	3.0	3.5	4.5	5.0	6.0	6.5	7.5	8.0	9.0
12 x 4 CFM	55	70	90	110	125	145	165	180	200	215
Ak_181 Throw	2.5	3.0	4.0	5.0	5.5	6.5	7.5	8.0	9.0	10.0
10 x 6 CFM	70	95	120	140	165	190	210	235	260	285
Ak_236 Throw	3.0	4.0	5.0	5.5	6.5	7.5	8.5	9.5	10.0	11.0
12 x 6 CFM	85	115	145	170	200	230	255	285	315	345
Ak_286 Throw	3.0	4.0	5.0	6.0	7.0	8.5	9.0	10.0	11.0	12.0
10 x 8 CFM	95	130	160	190	225	255	290	320	350	385
Ak_320 Throw	3.0	4.5	5.5	6.5	7.5	8.5	10.0	11.0	12.0	13.0
14 x 6 CFM	100	135	170	200	235	270	300	335	370	405
Ak_336 Throw	3.5	4.5	5.5	6.5	8.0	9.0	10.0	11.0	12.0	13.0
12 x 8 CFM	120	160	200	235	275	315	355	395	435	475
Ak_395 Throw	3.5	5.0	6.0	7.0	8.0	10.0	11.0	12.0	13.0	15.0
14 x 8 CFM	140	185	230	275	320	370	415	460	505	550
Ak_460 Throw	4.0	5.5	6.5	8.0	9.0	10.5	11.5	13.0	14.5	15.5

For sizes not listed or sizing tips see page 35

Terminal Velocity of 75 FPM

631 Register (Page 18)

Face Velocity		300	400	500	600	700	800	900	1000
Pressure Loss		.006	.010	.016	.022	.031	.040	.050	.062
10 x 6	CFM	85	110	140	170	195	225	250	280
Ak .18	Throw L/S	4.0/8.0	5.5/10.0	7.0/13.0	8.5/16.0	9.5/19.0	11.0/21.0	13.0/24.0	15.0/26.0
12 x 6	CFM	100	135	170	205	240	275	305	340
Ak .34	Throw L/S	4.0/8.0	5.0/10.0	6.0/13.0	7.5/16.0	9.0/20.0	10.0/22.0	11.5/24.0	13.0/28.0
10 x 8	CFM	115	150	190	230	265	305	340	380
Ak .38	Throw L/S	3.5/9.5	5.0/13.0	6.0/16.0	7.0/18.0	8.0/21.0	9.0/24.0	10.5/29.0	11.5/32.0
14 x 6	CFM	120	160	200	240	280	320	360	400
Ak .40	Throw L/S	4.0/10.0	5.0/12.0	6.5/16.0	8.0/19.0	9.0/22.0	10.0/24.0	11.0/27.0	12.5/30.0
12 x 8	CFM	140	190	235	280	330	375	425	470
Ak .47	Throw L/S	4.5/10.0	6.0/13.0	7.5/15.0	9.0/18.0	10.0/21.0	11.5/25.0	13.0/28.0	14.5/31.0
14 x 8	CFM	165	220	275	330	385	440	495	550
Ak .55	Throw L/S	4.0/10.0	5.5/13.5	7.5/18.0	8.5/22.0	10.0/25.0	11.5/29.0	13.0/33.0	15.0/36.0

Terminal Velocity of 75 FPM

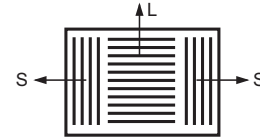

650 & A650 Return Air Grille (Page 18)

659 Return Air Filter Grille (Page 19)

Face Velocity*		300	400	500	600
6 x 4	CFM	33	44	55	66
Ak .111	Ps	.010	.018	.029	.041
6 x 6	CFM	50	67	83	100
Ak .167	Ps	.010	.018	.029	.041
8 x 4	CFM	44	59	74	89
Ak .148	Ps	.010	.018	.029	.041
8 x 6	CFM	67	89	112	134
Ak .223	Ps	.010	.018	.029	.041
8 x 8	CFM	90	120	150	179
Ak .299	Ps	.010	.018	.029	.041
10 x 4	CFM	56	74	93	111
Ak .186	Ps	.010	.018	.029	.041
10 x 6	CFM	84	112	140	168
Ak .280	Ps	.010	.018	.029	.041
10 x 8	CFM	112	150	187	225
Ak .375	Ps	.010	.018	.029	.041
10 x 10	CFM	141	188	235	282
Ak .470	Ps	.010	.018	.029	.041
12 x 6	CFM	101	135	168	202
Ak .337	Ps	.010	.018	.029	.041
12 x 8	CFM	135	180	226	271
Ak .451	Ps	.010	.018	.029	.041
12 x 10	CFM	170	226	283	339
Ak .566	Ps	.010	.018	.029	.041
12 x 12	CFM	204	272	340	408
Ak .681	Ps	.010	.018	.029	.041
12 x 18	CFM	308	411	513	616
Ak 1.027	Ps	.010	.018	.029	.041
14 x 6	CFM	118	158	197	236
Ak .394	Ps	.010	.018	.029	.041
14 x 8	CFM	158	211	264	316
Ak .527	Ps	.010	.018	.029	.041
14 x 10	CFM	198	265	331	397
Ak .661	Ps	.010	.018	.029	.041
14 x 12	CFM	239	318	398	477
Ak .796	Ps	.010	.018	.029	.041
14 x 14	CFM	279	372	465	558
Ak .930	Ps	.010	.018	.029	.041
14 x 18	CFM	360	480	600	720
Ak 1.200	Ps	.010	.018	.029	.041

Face Velocity*		300	400	500	600
16 x 6	CFM	135	180	226	271
Ak .451	Ps	.010	.018	.029	.041
16 x 8	CFM	181	242	302	362
Ak .604	Ps	.010	.018	.029	.041
16 x 10	CFM	227	303	379	454
Ak .757	Ps	.010	.018	.029	.041
16 x 12	CFM	273	364	455	547
Ak .911	Ps	.010	.018	.029	.041
16 x 14	CFM	320	426	533	639
Ak 1.065	Ps	.010	.018	.029	.041
16 x 16	CFM	366	488	610	732
Ak 1.219	Ps	.010	.018	.029	.041
16 x 24	CFM	552	736	920	1104
Ak 1.840	Ps	.010	.018	.029	.041
18 x 6	CFM	153	203	254	305
Ak .508	Ps	.010	.018	.029	.041
18 x 18	CFM	465	619	774	929
Ak 1.548	Ps	.010	.018	.029	.041
20 x 6	CFM	170	226	283	339
Ak .566	Ps	.010	.018	.029	.041
20 x 10	CFM	285	380	475	570
Ak .949	Ps	.010	.018	.029	.041
20 x 12	CFM	343	457	571	685
Ak 1.142	Ps	.010	.018	.029	.041
20 x 14	CFM	401	534	668	801
Ak 1.335	Ps	.010	.018	.029	.041
20 x 20	CFM	575	767	959	1150
Ak 1.917	Ps	.010	.018	.029	.041
20 x 24	CFM	692	923	1153	1384
Ak 2.307	Ps	.010	.019	.029	.042
20 x 25	CFM	721	962	1202	1442
Ak 2.404	Ps	.010	.019	.029	.042

For sizes not listed and sizing tips see page 35

Face Velocity*		300	400	500	600
24 x 4	CFM	135	180	226	271
Ak .451	Ps	.010	.018	.029	.041
24 x 6	CFM	204	272	340	408
Ak .681	Ps	.010	.018	.029	.041
24 x 8	CFM	273	364	455	547
Ak .911	Ps	.010	.018	.029	.041
24 x 10	CFM	343	457	571	685
Ak 1.142	Ps	.010	.018	.029	.041
24 x 12	CFM	412	550	687	825
Ak 1.374	Ps	.010	.018	.029	.041
24 x 14	CFM	482	643	803	964
Ak 1.607	Ps	.010	.018	.029	.041
24 x 24	CFM	832	1110	1387	1665
Ak 2.775	Ps	.010	.019	.029	.042
30 x 4	CFM	170	226	283	339
Ak .566	Ps	.010	.018	.029	.041
30 x 6	CFM	256	341	427	512
Ak .853	Ps	.010	.018	.029	.041
30 x 8	CFM	343	457	571	685
Ak 1.142	Ps	.010	.018	.029	.041
30 x 10	CFM	430	573	716	859
Ak 1.432	Ps	.010	.018	.029	.041
30 x 12	CFM	517	689	862	1034
Ak 1.723	Ps	.010	.018	.029	.041
30 x 14	CFM	604	806	1007	1209
Ak 2.015	Ps	.010	.018	.029	.042
30 x 18	CFM	780	1040	1300	1560
Ak 2.599	Ps	.010	.019	.029	.042
30 x 20	CFM	868	1157	1446	1735
Ak 2.892	Ps	.010	.019	.029	.042
30 x 24	CFM	1044	1392	1740	2088
Ak 3.479	Ps	.010	.019	.029	.042
30 x 30	CFM	1309	1745	2181	2618
Ak 4.363	Ps	.010	.019	.029	.042
36 x 6	CFM	308	411	513	616
Ak 1.027	Ps	.010	.018	.029	.041
36 x 8	CFM	412	550	687	825
Ak 1.374	Ps	.010	.018	.029	.041

*Filter grilles: Tested without filters. Typical capacity is 2 CFM per square inch of nominal filter area. Recommended face velocity is 300-450 FPM. Velocities higher will decrease filter performance, increase flow resistance, and possibly be of noise concern. Velocity measured 1" from face.

651 Baseboard Register (Page 19)

Face Velocity		300	400	500	600	700	800	900	1000
Pressure Loss		.006	.010	.016	.022	.031	.040	.050	.062
8 x 4	CFM	33	44	55	66	77	88	100	110
Ak .110	Throw	6.0	8.0	10.0	12.0	14.0	16.0	18.0	20.0
10 x 4	CFM	40	54	67	80	95	110	120	135
Ak .135	Throw	6.5	8.5	10.5	12.5	15.0	17.5	19.0	21.0
12 x 4 and 8 x 6	CFM	55	72	90	108	125	145	162	180
Ak .180	Throw	7.5	10.0	12.5	15.0	17.5	20.5	23.0	25.0
10 x 6	CFM	70	92	115	140	160	185	205	230
Ak .230	Throw	9.0	11.5	14.5	17.5	20.0	23.0	25.5	29.0
12 x 6	CFM	85	115	145	175	205	230	260	290
Ak .290	Throw	10.0	13.0	17.0	20.0	23.5	26.5	30.0	33.0
14 x 6	CFM	102	135	170	205	240	270	305	340
Ak .340	Throw	11.0	14.5	18.0	22.0	25.5	29.0	32.5	36.0

Terminal Velocity of 75 FPM

672/674 Return Air Grille (Page 21, 11)

673 Return Air Filter Grille (Page 21)

Face Velocity*		300	400	500	600
6 x 4	CFM	34	45	56	68
Ak .110	Ps	.020	.035	.054	.079
6 x 6	CFM	50	67	84	101
Ak .170	Ps	.019	.035	.054	.079
8 x 4	CFM	45	60	75	90
Ak .150	Ps	.019	.035	.054	.079
8 x 6	CFM	67	89	111	134
Ak .220	Ps	.019	.035	.054	.079
8 x 8	CFM	89	118	148	178
Ak .300	Ps	.019	.035	.054	.078
10 x 4	CFM	56	74	93	112
Ak .190	Ps	.019	.035	.054	.079
10 x 6	CFM	83	111	139	167
Ak .280	Ps	.019	.035	.054	.078
10 x 8	CFM	111	147	184	221
Ak .370	Ps	.019	.034	.054	.078
10 x 10	CFM	138	184	230	276
Ak .460	Ps	.019	.034	.054	.078
12 x 6	CFM	100	133	166	199
Ak .330	Ps	.019	.034	.054	.078
12 x 8	CFM	132	177	221	265
Ak .440	Ps	.019	.034	.054	.078
12 x 10	CFM	165	220	275	330
Ak .550	Ps	.019	.034	.053	.077
12 x 12	CFM	197	263	329	395
Ak .660	Ps	.019	.034	.053	.077
12 x 18	CFM	294	392	491	589
Ak .980	Ps	.019	.034	.053	.075
14 x 6	CFM	116	155	193	232
Ak .390	Ps	.019	.034	.054	.078
14 x 8	CFM	154	205	257	308
Ak .510	Ps	.019	.034	.053	.077
14 x 10	CFM	192	256	320	384
Ak .640	Ps	.019	.034	.053	.077
14 x 12	CFM	230	306	383	460
Ak .770	Ps	.019	.034	.053	.076
14 x 14	CFM	267	357	446	535
Ak .890	Ps	.019	.034	.053	.075
14 x 18	CFM	343	457	571	685
Ak 1.140	Ps	.019	.033	.052	.074

Face Velocity*		300	400	500	600
16 x 6	CFM	132	177	221	265
Ak .440	Ps	.019	.034	.054	.078
16 x 8	CFM	176	234	293	352
Ak .590	Ps	.019	.034	.053	.077
16 x 10	CFM	219	292	365	438
Ak .730	Ps	.019	.034	.053	.076
16 x 12	CFM	262	349	437	524
Ak .870	Ps	.019	.034	.053	.076
16 x 14	CFM	305	407	509	610
Ak 1.020	Ps	.019	.034	.052	.075
16 x 16	CFM	348	464	580	696
Ak 1.160	Ps	.019	.033	.052	.074
16 x 24	CFM	519	692	865	1038
Ak 1.730	Ps	.018	.033	.051	.071
16 x 25	CFM	540	720	900	1081
Ak 1.800	Ps	.018	.033	.051	.071
18 x 6	CFM	149	198	248	297
Ak .500	Ps	.019	.034	.054	.077
18 x 18	CFM	439	585	732	878
Ak 1.460	Ps	.019	.033	.052	.073
18 x 24	CFM	583	777	971	1166
Ak 1.940	Ps	.018	.032	.051	.070
20 x 6	CFM	165	220	275	330
Ak .550	Ps	.019	.034	.053	.077
20 x 10	CFM	273	364	455	546
Ak .910	Ps	.019	.034	.053	.075
20 x 12	CFM	327	435	544	653
Ak 1.090	Ps	.019	.033	.052	.074
20 x 14	CFM	380	507	634	760
Ak 1.270	Ps	.019	.033	.052	.074
20 x 20	CFM	540	720	900	1081
Ak 1.800	Ps	.018	.033	.051	.071
20 x 24	CFM	647	862	1078	1293
Ak 2.160	Ps	.018	.032	.050	.069
20 x 25	CFM	673	898	1122	1346
Ak 2.240	Ps	.018	.032	.050	.069

Face Velocity*		300	400	500	600
24 x 4	CFM	132	177	221	265
Ak .440	Ps	.019	.034	.054	.078
24 x 6	CFM	197	263	329	395
Ak .660	Ps	.019	.034	.053	.077
24 x 8	CFM	262	349	437	524
Ak .870	Ps	.019	.034	.053	.076
24 x 10	CFM	327	435	544	653
Ak 1.090	Ps	.019	.033	.052	.074
24 x 12	CFM	391	521	651	782
Ak 1.300	Ps	.019	.033	.052	.073
24 x 14	CFM	455	607	758	910
Ak 1.520	Ps	.019	.033	.051	.072
24 x 24	CFM	774	1032	1290	1548
Ak 2.580	Ps	.018	.032	.049	.067
30 x 4	CFM	165	220	275	330
Ak .550	Ps	.019	.034	.053	.077
30 x 6	CFM	246	328	410	492
Ak .820	Ps	.019	.034	.053	.076
30 x 8	CFM	327	435	544	653
Ak 1.090	Ps	.019	.033	.052	.074
30 x 10	CFM	407	543	678	814
Ak 1.360	Ps	.019	.033	.052	.073
30 x 12	CFM	487	649	812	974
Ak 1.620	Ps	.018	.033	.051	.072
30 x 14	CFM	567	756	945	1134
Ak 1.890	Ps	.018	.032	.051	.071
30 x 18	CFM	726	968	1210	1452
Ak 2.420	Ps	.018	.032	.050	.068
30 x 20	CFM	806	1074	1343	1611
Ak 2.690	Ps	.018	.031	.049	.067
30 x 24	CFM	964	1286	1607	1928
Ak 3.210	Ps	.017	.031	.048	.064
30 x 30	CFM	1201	1602	2002	2403
Ak 4.000	Ps	.017	.030	.046	.060
36 x 8	CFM	391	521	651	782
Ak 1.300	Ps	.019	.033	.052	.073

For sizes not listed and sizing tips see page 35

*Filter grilles: Tested without filters. Typical capacity is 2 CFM per square inch of nominal filter area. Recommended face velocity is 300-450 FPM. Velocities higher will decrease filter performance, increase flow resistance, and possibly be of noise concern. Velocity measured 1" from face.

661 & A661 2-Way Supply Register (Page 20)

Face Velocity		300	400	500	600	700	800	900	1000
Pressure Loss		.006	.010	.016	.022	.031	.040	.050	.062
6 x 4	CFM	25	30	40	50	55	65	70	80
Ak .080	Throw	4.0	4.5	6.0	7.0	8.5	10.0	11.0	12.5
8 x 4	CFM	35	45	55	65	75	90	100	110
Ak .110	Throw	4.5	5.5	7.0	8.5	10.0	11.5	13.0	14.5
10 x 4 and 8 x 5	CFM	45	60	75	85	100	115	130	145
Ak .145	Throw	5.0	6.5	8.0	9.5	11.5	13.0	14.5	16.0
12 x 4 and 8 x 6	CFM	55	70	90	110	125	145	160	180
Ak .180	Throw	5.5	7.0	9.0	10.5	12.5	14.0	16.0	18.0
14 x 4	CFM	65	85	110	130	150	170	195	215
Ak .215	Throw	6.0	7.5	9.5	11.5	13.5	15.5	17.0	19.0
10 x 6 and 12 x 5	CFM	75	100	125	145	170	195	220	245
Ak .245	Throw	6.0	8.0	10.0	12.0	14.0	16.0	18.0	20.0
12 x 6 and 14 x 5	CFM	90	120	150	175	205	235	265	295
Ak .295	Throw	6.5	8.5	11.0	13.0	15.5	17.5	19.5	22.0
10 x 8	CFM	105	140	175	205	240	275	310	345
Ak .345	Throw	7.0	9.0	11.5	13.5	16.5	18.5	21.0	23.5
14 x 6	CFM	110	145	180	215	250	290	325	360
Ak .360	Throw	7.0	9.5	12.0	14.0	16.5	19.0	21.5	24.0

Terminal Velocity of 75 FPM

Face Velocity		300	400	500	600	700	800	900	1000
Pressure Loss		.006	.010	.016	.022	.031	.040	.050	.062
16 x 6 and 12 x 8	CFM	130	170	215	255	300	340	385	425
Ak .425	Throw	7.5	10.0	12.5	15.0	18.0	20.5	23.0	25.5
14 x 8	CFM	155	205	260	310	360	410	465	515
Ak .515	Throw	8.0	10.5	14.0	16.0	19.5	22.0	25.0	28.0
20 x 6	CFM	165	220	275	330	385	440	495	550
Ak .550	Throw	8.5	11.0	14.5	17.0	20.0	23.0	25.5	29.0
16 x 8	CFM	180	240	300	360	420	480	540	600
Ak .600	Throw	8.5	11.0	14.5	17.0	20.0	23.0	25.5	29.0
24 x 6 and 18 x 8	CFM	205	270	340	410	475	545	610	680
Ak .680	Throw	9.5	12.0	15.5	18.5	22.0	25.0	28.0	31.5
20 x 8	CFM	230	305	380	455	530	610	685	760
Ak .760	Throw	10.0	13.0	16.5	19.0	23.0	26.0	28.5	33.0
30 x 6	CFM	265	350	440	530	615	705	790	880
Ak .880	Throw	10.5	14.0	17.5	20.5	24.5	28.0	31.5	35.0
24 x 8	CFM	295	390	490	590	685	785	880	980
Ak .980	Throw	11.0	14.0	18.0	21.5	25.5	29.0	33.0	37.0
30 x 8	CFM	375	500	625	750	875	1000	1125	1250
Ak 1.250	Throw	12.0	16.0	20.0	24.0	28.5	32.0	37.0	41.0

681 One-Way Sidewall/Ceiling Register
(Page 21)

681M One-Way Sidewall/Ceiling Register
(Page 23)

Face Velocity	300	400	500	600	700	800	900	1000
Pressure Loss	.006	.010	.016	.022	.031	.040	.050	.062
8 x 6 CFM	40	55	70	90	100	110	125	140
Ak .140 Throw	5.0	6.0	8.0	9.0	11.0	12.0	14.0	15.0
10 x 6 CFM	55	80	95	110	130	150	165	185
Ak .185 Throw	5.0	7.0	10.0	11.0	13.0	14.0	16.0	18.0
12 x 6 CFM	70	90	115	135	160	180	205	225
Ak .225 Throw	6.0	8.0	12.0	12.0	14.0	16.0	18.0	20.0
14 x 6 CFM	85	115	145	175	205	230	260	290
Ak .290 Throw	7.0	9.0	16.0	14.0	17.0	19.0	21.0	24.0
16 x 6 CFM	100	130	165	200	230	265	295	330
Ak .330 Throw	8.0	10.0	18.0	15.0	18.0	20.0	23.0	25.0
18 x 6 CFM	115	155	195	235	275	310	350	390
Ak .390 Throw	8.0	11.0	21.0	17.0	20.0	22.0	25.0	28.0
20 x 6 CFM	130	175	220	265	310	360	395	440
Ak .440 Throw	5.0	12.0	24.0	18.0	21.0	24.0	27.0	30.0

Terminal Velocity of 75 FPM

683 Three-Way Sidewall/Ceiling Register
(Page 22)

683M Three-Way Sidewall/Ceiling Register
(Page 23)

Face Velocity	300	400	500	600	700	800	900	1000
Pressure Loss	.006	.010	.016	.022	.031	.040	.050	.062
8 x 4 Total CFM	25	35	45	55	65	70	80	90
CFM L/S	13/6	17/9	24/11	29/13	34/16	37/17	42/19	48/22
Ak .090 Throw L/S	3.0/2.5	4.0/3.0	5.0/3.5	6.0/4.0	7.0/5.0	7.5/5.5	8.5/6.0	10.0/6.5
6 x 6 Total CFM	30	40	50	65	75	85	95	105
CFM L/S	10/10	13/14	16/17	21/22	24/26	27/29	30/32	34/36
Ak .105 Throw L/S	3.0/3.0	3.5/3.5	4.0/4.0	5.5/5.5	6.0/6.0	7.0/7.0	8.0/8.0	9.0/9.0
10 x 4 Total CFM	35	45	60	70	80	90	105	115
CFM L/S	21/7	29/8	38/11	45/13	51/14	58/16	67/19	74/21
Ak .115 Throw L/S	4.0/2.0	5.0/2.5	6.0/3.5	7.5/4.0	8.5/4.5	9.5/5.0	11.0/6.0	12.0/6.5
12 x 4 Total CFM	40	55	70	85	100	110	125	140
CFM L/S	21/10	29/13	36/17	44/20	52/24	57/26	66/30	73/34
Ak .140 Throw L/S	3.5/2.5	5.0/3.0	6.0/4.0	7.5/5.0	8.5/5.5	9.5/6.0	10.5/7.0	12.0/8.0
10 x 6 Total CFM	55	75	95	110	130	150	165	185
CFM L/S	35/10	48/14	61/17	70/20	83/23	96/27	106/30	118/33
Ak .185 Throw L/S	4.5/2.5	6.5/3.5	8.0/4.0	9.0/5.0	11.0/5.5	12.5/6.5	14.0/7.5	15.5/8.0
8 x 8 Total CFM	60	80	100	120	140	160	180	200
CFM L/S	31/14	42/19	52/24	62/29	73/34	83/38	94/43	104/48
Ak .200 Throw L/S	4.5/3.0	6.0/4.0	7.5/5.0	8.5/6.0	10.5/7.0	11.5/8.0	13.0/9.0	14.5/10.0
12 x 6 Total CFM	70	90	115	135	160	180	205	225
CFM L/S	36/17	47/22	60/28	70/32	83/38	94/43	107/49	117/54
A .225 Throw L/S	4.5/3.5	6.0/4.0	8.0/5.5	9.0/6.0	11.0/7.5	12.5/8.0	14.0/9.5	15.5/10.5
14 x 6 Total CFM	85	115	145	175	205	230	260	290
CFM L/S	51/17	69/23	87/29	105/35	123/41	138/46	156/52	174/58
Ak .290 Throw L/S	5.5/3.5	7.5/4.5	10.0/5.5	12.0/6.5	14.0/8.0	15.5/9.0	18.0/10.0	20.0/11.0
10 x 10 Total CFM	95	125	155	185	215	250	280	310
CFM L/S	61/17	80/23	99/28	118/33	138/39	160/45	179/50	198/56
Ak .310 Throw L/S	6.0/3.5	8.0/4.5	10.0/5.5	12.0/6.5	14.0/7.5	16.5/9.0	18.0/9.5	20.0/10.5
12 x 8 Total CFM	95	130	160	190	225	255	290	320
CFM L/S	49/23	68/31	83/38	99/46	117/54	133/61	151/70	166/77
Ak .320 Throw L/S	5.5/4.0	7.5/5.0	9.5/6.0	11.0/7.5	13.0/9.0	15.0/10.0	17.0/11.5	19.0/12.5
14 x 8 Total CFM	115	155	195	235	275	310	350	390
CFM L/S	69/23	93/31	117/39	141/47	165/55	186/62	210/70	234/78
Ak .390 Throw L/S	6.5/4.0	9.0/5.0	11.0/6.0	13.5/7.5	16.0/9.0	18.0/10.0	20.0/11.5	22.0/12.5
12 x 12 Total CFM	140	190	235	280	330	375	425	470
CFM L/S	73/34	99/46	122/56	146/67	172/79	195/90	221/102	244/113
Ak .470 Throw L/S	7.0/4.5	9.0/6.0	11.5/7.5	13.5/9.0	16.0/10.5	18.0/12.0	20.0/14.0	23.0/15.5
14 x 14 Total CFM	195	260	325	390	455	520	585	650
CFM L/S	117/39	156/52	195/65	234/78	273/91	312/104	351/117	390/130
Ak .650 Throw L/S	8.5/5.0	11.5/6.5	14.0/8.0	17.0/9.5	20.0/11.5	23.0/13.0	26.0/14.5	28.0/16.0
16 x 16 Total CFM	280	370	465	560	650	745	835	930
CFM L/S	164/67	192/89	242/112	291/134	338/156	387/179	434/200	484/223
Ak .930 Throw L/S	10.0/6.5	13.0/9.0	16.5/11.0	20.0/13.0	23.0/15.5	26.0/17.0	29.0/20.0	33.0/22.0

Terminal Velocity of 75 FPM

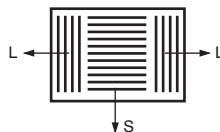

682 Two-Way Sidewall/Ceiling Register
(Page 22)

682M Two-Way Sidewall/Ceiling Register
(Page 23)

Face Velocity	300	400	500	600	700	800	900	1000
Pressure Loss	.006	.010	.016	.022	.031	.040	.050	.062
8 x 4 CFM	25	35	45	55	65	70	80	90
Ak .090 Throw	2.0	3.5	4.5	5.5	6.5	7.0	8.0	9.0
6 x 6 CFM	30	40	50	65	75	85	95	105
Ak .105 Throw	3.0	3.5	4.5	6.0	7.0	8.0	9.0	10.0
10 x 4 CFM	35	45	60	70	80	90	105	115
Ak .115 Throw	3.5	4.0	5.0	6.0	7.0	8.0	9.0	10.0
12 x 4 CFM	40	55	70	85	100	110	125	140
Ak .140 Throw	3.5	4.5	5.5	6.5	8.0	9.0	10.0	11.5
10 x 6 CFM	55	75	95	110	130	150	165	185
Ak .185 Throw	4.0	5.0	6.5	8.0	9.0	10.5	12.0	13.0
8 x 8 CFM	60	80	100	120	140	160	180	200
Ak .200 Throw	4.0	5.5	7.0	8.0	9.5	11.0	12.5	13.5
12 x 6 CFM	70	90	115	135	160	180	205	225
Ak .225 Throw	4.5	6.0	7.5	8.5	10.5	12.0	13.0	14.5
14 x 6 CFM	85	115	145	175	205	230	260	290
Ak .290 Throw	5.0	6.5	8.5	10.0	11.5	13.5	15.0	17.0
10 x 10 CFM	95	125	155	185	215	250	280	310
Ak .310 Throw	5.0	7.0	8.5	10.0	12.0	14.0	15.5	17.0
12 x 8 CFM	95	130	160	190	225	255	290	320
Ak .320 Throw	5.5	7.0	9.0	10.5	12.5	14.0	16.0	18.0
14 x 8 CFM	115	155	195	235	275	310	350	390
Ak .390 Throw	6.0	8.0	10.0	12.0	14.0	16.0	18.0	20.0
12 x 12 CFM	140	190	235	280	330	375	425	470
Ak .470 Throw	6.5	8.5	10.5	12.5	15.0	17.0	19.0	21.0

Terminal Velocity of 75 FPM

684 Four-Way Sidewall/Ceiling Register
(Page 22)

684 Four-Way Sidewall/Ceiling Register
(Page 23)

Face Velocity	300	400	500	600	700	800	900	1000
Pressure Loss	.006	.010	.016	.022	.031	.040	.050	.062
6 x 6 Total CFM	30	40	50	65	75	85	95	105
CFM L/S	4/11	6/14	8/17	10/22	12/26	14/29	15/32	17/36
Ak .105 Throw L/S	2.0/3.0	2.0/3.5	3.0/4.0	3.5/5.5	4.5/6.5	5.0/7.0	5.5/8.0	6.0/9.0
8 x 8 Total CFM	60	80	100	120	140	160	180	200
CFM L/S	16/14	21/19	26/24	31/29	37/34	42/38	47/43	52/48
Ak .200 Throw L/S	3.0/3.0	4.0/4.0	5.0/5.0	6.0/6.0	7.5/7.0	8.5/8.0	9.5/9.0	10.5/10.0
10 x 10 Total CFM	95	125	155	185	215	250	280	310
CFM L/S	31/17	40/23	50/28	59/33	69/39	80/45	90/50	99/56
Ak .310 Throw L/S	4.5/3.5	6.0/4.5	7.0/5.5	8.5/6.5	10.0/7.5	11.0/9.0	13.0/9.5	14.5/10.5
12 x 12 Total CFM	140	190	235	280	330	375	425	470
CFM L/S	37/34	50/46	61/56	73/67	86/79	98/90	111/102	122/113
Ak .470 Throw L/S	5.0/4.5	6.5/6.0	8.0/7.5	9.5/9.0	11.5/10.5	13.0/12.0	14.5/14.0	16.0/15.5
14 x 14 Total CFM	195	260	325	390	455	520	585	650
CFM L/S	59/39	78/52	98/65	117/78	137/91	156/104	176/117	195/130
Ak .650 Throw L/S	6.0/5.0	8.0/6.5	10.0/8.0	12.0/9.5	14.0/11.5	16.0/13.0	18.0/14.5	20.0/16.0
16 x 16 Total CFM	280	370	465	560	650	745	835	930
CFM L/S	73/67	96/89	121/112	146/134	169/156	194/179	217/200	242/223
Ak .930 Throw L/S	7.0/6.5	9.0/9.0	11.5/11.0	14.0/13.0	16.0/15.5	19.0/17.0	21.0/20.0	23.0/22.0

Terminal Velocity of 75 FPM

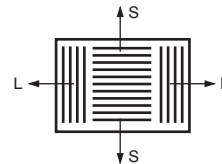

Rezzin 2-Way Register (Page 26)

Face Velocity		300	400	500	600	700	800	900	1000
8 x 4 Ak .095	CFM	28	38	47	57	66	76	85	95
	Ps	.02	.02	.02	.03	.04	.05	.06	.07
	Throw	1.5	2.0	2.5	3.0	3.5	4.0	4.5	5.0
10 x 4 Ak .117	CFM	35	47	59	70	82	94	105	117
	Ps	.01	.01	.02	.02	.03	.04	.05	.06
	Throw	1.5	2.0	2.5	3.0	3.5	4.0	4.5	5.0
10 x 6 Ak .193	CFM	58	77	97	116	135	154	174	193
	Ps	.01	.01	.02	.02	.03	.04	.05	.06
	Throw	1.5	2.0	2.5	3.0	3.5	4.5	5.0	5.5
12 x 6 Ak .238	CFM	71	95	119	143	167	190	214	238
	Ps	.01	.01	.01	.02	.03	.04	.05	.06
	Throw	5.5	7.0	9.0	10.5	12.5	14.0	16.0	17.5
14 x 6 Ak .291	CFM	87	116	145	174	204	233	262	291
	Ps	.01	.01	.02	.02	.03	.04	.05	.06
	Throw	NA	NA	NA	NA	NA	NA	NA	NA
14 x 8 Ak .395	CFM	119	158	198	237	277	316	356	395
	Ps	.01	.01	.01	.02	.03	.04	.05	.06
	Throw	NA	NA	NA	NA	NA	NA	NA	NA

Terminal Velocity of 75 FPM

NA = Not Available

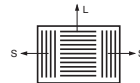

Rezzin 3-Way Register (Page 26)

Face Velocity		300	400	500	600	700	800	900	1000
8 x 4 Ak .108	CFM	32	43	54	65	75	86	97	108
	Ps	.01	.01	.02	.03	.04	.05	.07	.08
	Throw Short	NA	NA	NA	NA	NA	NA	NA	NA
	Throw Long	NA	NA	NA	NA	NA	NA	NA	NA
10 x 6 Ak .193	CFM	58	77	97	116	135	154	174	193
	Ps	.01	.01	.02	.03	.03	.04	.05	.06
	Throw Short	2.0	3.0	3.5	4.0	5.0	5.5	6.5	7.0
	Throw Long	1.0	1.5	2.0	2.5	2.5	3.0	3.5	4.0
10 x 8 Ak .246	CFM	74	98	123	148	172	197	221	246
	Ps	.01	.01	.01	.02	.03	.03	.04	.05
	Throw Short	1.5	2.0	2.5	3.0	3.5	4.0	4.5	5.0
	Throw Long	2.5	3.5	4.5	5.0	6.0	7.0	7.5	8.5
12 x 6 Ak .238	CFM	71	95	119	143	167	190	214	238
	Ps	.01	.01	.02	.02	.03	.04	.05	.07
	Throw Short	2.5	3.5	4.5	5.0	6.0	7.0	7.5	8.5
	Throw Long	2.5	3.5	4.5	5.0	6.0	7.0	7.5	8.5
14 x 6 Ak .297	CFM	89	119	148	178	208	237	267	297
	Ps	.01	.01	.02	.03	.03	.04	.06	.07
	Throw Short	NA	NA	NA	NA	NA	NA	NA	NA
	Throw Long	NA	NA	NA	NA	NA	NA	NA	NA
14 x 8 Ak .399	CFM	120	160	199	239	279	319	359	399
	Ps	.01	.01	.01	.02	.03	.04	.05	.06
	Throw Short	NA	NA	NA	NA	NA	NA	NA	NA
	Throw Long	NA	NA	NA	NA	NA	NA	NA	NA

Terminal Velocity of 75 FPM

NA = Not Available

Rezzin 4-Way Register (Page 26)

Face Velocity		300	400	500	600	700	800	900	1000
6 x 6 Ak .124	CFM	37	49	62	74	87	99	111	124
	Ps	.01	.01	.02	.03	.03	.05	.06	.07
	Throw	NA	NA	NA	NA	NA	NA	NA	NA
8 x 8 Ak .231	CFM	69	92	115	139	162	185	208	231
	Ps	.00	.01	.01	.02	.02	.03	.04	.04
	Throw	NA	NA	NA	NA	NA	NA	NA	NA
10 x 10 Ak .347	CFM	104	139	173	208	243	277	312	347
	Ps	.01	.01	.02	.02	.03	.04	.05	.07
	Throw	NA	NA	NA	NA	NA	NA	NA	NA
12 x 12 Ak .510	CFM	153	204	255	306	357	408	459	510
	Ps	.01	.01	.02	.02	.03	.04	.05	.07
	Throw	NA	NA	NA	NA	NA	NA	NA	NA

Terminal Velocity of 75 FPM

NA = Not Available

16 Round Ceiling Diffuser (Page 28)

Face Velocity		300	400	500	600	700	800	900	1000
Pressure Loss		.006	.010	.016	.022	.031	.040	.050	.062
Neck Size 6"	CFM		55	65	80	95	105	120	135
Ak .135	Throw		2.5	3.0	3.5	4.0	4.5	5.0	5.5
Neck Size 8"	CFM	70	90	115	135	160	180	200	225
Ak .225	Throw	2.0	3.0	3.5	4.5	5.0	5.5	6.5	7.0
Neck Size 10"	CFM	105	140	175	210	240	275	310	345
Ak .345	Throw	2.5	3.5	4.5	5.0	6.0	7.0	8.0	8.5
Neck Size 12"	CFM	150	200	250	300	350	400	450	500
Ak .500	Throw	3.0	4.0	5.0	6.0	7.5	8.5	9.0	10.5
Neck Size 14"	CFM	190	250	315	375	440	500	565	625
Ak .625	Throw	3.5	4.5	5.5	6.5	8.0	9.0	10.0	11.0
Neck Size 18"	CFM	310	415	520	625	730	830	935	1040
Ak 1.040	Throw	4.5	6.0	7.0	8.5	10.0	11.5	13.0	14.5

Terminal Velocity of 50 FPM

24 Square Ceiling Diffuser (Page 29)

Face Velocity		300	400	500	600	700	800	900	1000
Pressure Loss		.006	.010	.016	.022	.031	.040	.050	.062
Neck Size 6"	CFM	50	65	85	100	115	130	150	165
Ak .165	Throw	3.5	4.5	5.5	6.5	8.0	9.0	10.0	11.0
Neck Size 8"	CFM	85	110	140	170	195	225	250	280
Ak .280	Throw	4.5	5.5	7.0	8.5	10.0	11.0	12.0	14.0
Neck Size 10"	CFM	125	170	210	250	295	335	380	420
Ak .420	Throw	5.0	6.5	8.0	9.5	11.5	13.0	15.0	16.0
Neck Size 12"	CFM	180	240	300	355	415	475	535	595
Ak .595	Throw	6.0	8.0	10.0	11.5	13.5	15.5	17.5	19.0
Neck Size 14"	CFM	245	330	410	490	575	655	740	820
Ak .820	Throw	7.0	9.0	11.5	13.5	16.0	18.0	20.0	22.5
Neck Size 16"	CFM	310	410	515	620	720	825	925	1030
Ak 1.030	Throw	7.5	10.0	12.5	15.0	18.0	20.0	22.0	25.0
Neck Size 18"	CFM	400	530	665	800	930	1065	1200	1330
Ak 1.330	Throw	8.5	11.0	14.0	17.0	20.0	23.0	26.0	28.0
Neck Size 20"	CFM	480	640	800	960	1120	1280	1440	1600
Ak 1.600	Throw	9.5	12.0	16.0	18.0	22.0	25.0	28.0	31.0
Neck Size 22"	CFM	570	760	950	1140	1330	1520	1710	1900
Ak 1.900	Throw	10.5	13.5	17.0	19.0	24.0	27.0	30.0	33.0
Neck Size 24"	CFM	690	920	1150	1380	1610	1840	2070	2300
Ak 2.300	Throw	11.0	14.5	18.5	22.0	26.0	30.0	33.0	36.0

Terminal Velocity of 50 FPM

A500 Series (Page 30, 31)

A501MS/A501OB One-Way Diffuser



Face Velocity	400	500	600	700	900	1100	1500
Pressure Loss	.010	.016	.022	.031	.050	.075	.140
6 x 6 CFM	55	65	75	90	120	140	195
Ak .13 Throw	5.0	6.0	7.0	8.0	10.0	12.0	15.0
8 x 8 CFM	75	90	105	120	150	180	240
Ak .20 Throw	6.0	7.0	8.0	10.0	12.0	15.0	18.0
10 x 10 CFM	115	135	155	175	235	290	395
Ak .29 Throw	7.0	8.0	10.0	12.0	15.0	19.0	24.0
12 x 12 CFM	170	210	255	300	380	470	610
Ak .42 Throw	8.0	10.0	12.0	15.0	19.0	24.0	29.0
14 x 14 CFM	250	305	360	410	505	610	800
Ak .59 Throw	11.0	13.0	15.0	18.0	24.0	30.0	35.0

A504MS/A504OB Four-Way Diffuser

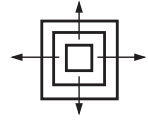

Face Velocity	400	500	600	700	900	1100	1500
Pressure Loss	.010	.016	.022	.031	.050	.075	.140
6 x 6 CFM	55	65	75	90	120	140	195
Ak .13 Throw	2.0	3.0	4.0	5.0	6.0	7.0	9.0
8 x 8 CFM	75	90	105	120	150	180	240
Ak .20 Throw	3.0	4.0	5.0	6.0	8.0	10.0	13.0
10 x 10 CFM	115	135	155	175	235	290	395
Ak .29 Throw	4.0	5.0	6.0	7.0	9.0	12.0	14.0
12 x 12 CFM	170	210	255	300	380	470	610
Ak .42 Throw	5.0	6.0	7.0	8.0	10.0	12.0	15.0
14 x 14 CFM	250	305	360	410	505	610	800
Ak .59 Throw	6.0	7.0	8.0	9.0	11.0	14.0	18.0

A502MS/A502OB Two-Way Diffuser

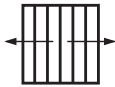

Face Velocity	400	500	600	700	900	1100	1500
Pressure Loss	.010	.016	.022	.031	.050	.075	.140
6 x 6 CFM	55	65	75	90	120	140	195
Ak .13 Throw	3.0	4.0	5.0	6.0	7.0	9.0	12.0
8 x 8 CFM	75	90	105	120	150	180	240
Ak .20 Throw	4.0	5.0	6.0	7.0	9.0	12.0	16.0
10 x 10 CFM	115	135	155	175	235	290	395
Ak .29 Throw	5.0	6.0	7.0	8.0	10.0	14.0	20.0
12 x 12 CFM	170	210	255	300	380	470	610
Ak .42 Throw	6.0	7.0	8.0	10.0	13.0	17.0	23.0
14 x 14 CFM	250	305	360	410	505	610	800
Ak .59 Throw	7.0	9.0	11.0	13.0	16.0	19.0	27.0

A505MS/A505OB Two-Way Corner Diffuser

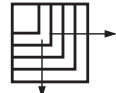

Face Velocity	400	500	600	700	900	1100	1500
Pressure Loss	.010	.016	.022	.031	.050	.075	.140
6 x 6 CFM	55	65	75	90	120	140	195
Ak .13 Throw	3.0	4.0	5.0	6.0	7.0	9.0	12.0
8 x 8 CFM	75	90	105	120	150	180	240
Ak .20 Throw	4.0	5.0	6.0	7.0	9.0	12.0	16.0
10 x 10 CFM	115	135	155	175	235	290	395
Ak .29 Throw	5.0	6.0	7.0	8.0	10.0	14.0	20.0
12 x 12 CFM	170	210	255	300	380	470	610
Ak .42 Throw	6.0	7.0	8.0	10.0	13.0	17.0	23.0
14 x 14 CFM	250	305	360	410	505	610	800
Ak .59 Throw	7.0	9.0	11.0	13.0	16.0	19.0	27.0

A503MS/A503OB Three-Way Diffuser

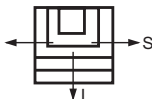

Face Velocity	400	500	600	700	900	1100	1500
Pressure Loss	.010	.016	.022	.031	.050	.075	.140
6 x 6 CFM	55	65	75	90	120	140	195
Ak .13 Throw L/S	3.5/2.5	4.0/3.0	5.0/3.5	5.5/4.0	7.0/5.0	9.0/6.0	12.0/9.0
8 x 8 CFM	75	90	105	120	150	180	240
Ak .20 Throw L/S	4.0/2.0	5.0/2.5	6.0/3.5	7.0/4.0	8.0/4.5	10.0/5.5	12.0/7.0
10 x 10 CFM	115	135	155	175	235	290	395
Ak .29 Throw L/S	5.0/3.0	7.0/4.0	8.0/4.5	10.0/5.5	12.0/7.0	14.0/8.5	18.0/10.5
12 x 12 CFM	170	210	255	300	380	470	610
Ak .42 Throw L/S	7.0/4.0	8.5/4.5	10.0/5.5	12.0/6.5	15.0/8.5	18.0/10.0	23.0/14.0
14 x 14 CFM	250	305	360	410	505	610	800
Ak .59 Throw L/S	8.0/5.5	10.0/6.0	11.5/7.0	13.0/7.5	15.5/9.0	20.0/11.0	27.0/16.0

<NC 20	NC 20-30	NC 30-35	NC 35-40

Terminal velocity of FPM
 NC Noise criteria rating. NC is based on 10db room absorption (ref. 10⁻¹² watts).
 Tested in accordance with ASHRAE 36-72, ADC 1062: GRD84 and ISO 3741.

Rezzin Round Ceiling Diffuser (Page 32)

Face Velocity		300	400	500	600	700	800	900	1000
Neck Size 6" Ak .224	CFM	67	89	112	134	157	179	201	224
	Ps	0.00	0.00	0.00	0.00	0.00	0.01	0.01	0.01
	Throw	1.50	2.00	2.50	3.00	3.50	4.00	4.50	5.00
Neck Size 7" Ak .229	CFM	69	92	115	137	160	183	206	229
	Ps	0.05	0.09	0.13	0.19	0.26	0.34	0.43	0.53
	Throw	1.75	2.25	2.75	3.25	3.75	4.25	5.00	5.50
Neck Size 8" Ak .235	CFM	70	94	117	141	164	188	211	235
	Ps	0.10	0.17	0.26	0.38	0.52	0.67	0.85	1.05
	Throw	2.00	2.50	3.00	3.50	4.00	4.50	5.50	6.00

Terminal Velocity of 50 FPM

Rezzin Square Ceiling Diffuser (Page 32)

Rezzin (two-way corner)

Neck Velocity		300	400	500	600	700
Neck Size 6" Ak 0.284	CFM	60	80	100	120	135
	Ps	0.002	0.004	0.006	0.008	0.011
	Throw	2.5	3.5	4.0	5.0	6.0
Vt 75	Throw	2.5	3.0	4.0	4.5	5.5
Vt 100	Throw	1.5	2.0	2.5	3.0	3.5
Vt 150	Throw					
Neck size 7" Ak 0.267	CFM	82	109	136	164	191
	Ps	0.009	0.016	0.025	0.037	0.050
	Throw	4.0	5.0	6.0	7.5	8.5
Vt 75	Throw	3.5	4.5	5.5	7.0	8.0
Vt 100	Throw	2.5	3.0	4.0	4.5	5.5
Vt 150	Throw					
Neck size 8" Ak 0.251	CFM	105	140	175	209	244
	Ps	0.016	0.029	0.045	0.065	0.088
	Throw	5.0	6.5	8.0	9.5	11.0
Vt 75	Throw	4.5	6.0	7.5	9.0	10.5
Vt 100	Throw	3.0	4.0	5.0	6.0	7.0
Vt 150	Throw					

Rezzin (three-way)

Neck Velocity		300	400	500	600	700
Neck Size 6" Ak 0.247	CFM	60	80	100	120	135
	Ps	0.002	0.004	0.006	0.008	0.011
	Throw	2.0	2.5	3.0	3.5	4.0
Vt 75 S/L	Throw	2.0	2.5	3.0	3.5	4.0
Vt 100 S/L	Throw	1.5	1.5	2.0	2.0	2.5
Vt 150 S/L	Throw					
Neck Size 7" Ak 0.243	CFM	80	110	135	165	190
	Ps	0.009	0.016	0.026	0.037	0.050
	Throw	2.5	4.0	4.5	5.5	6.0
Vt 75 S/L	Throw	2.5	3.5	4.0	5.0	5.5
Vt 100 S/L	Throw	1.8	2.5	3.0	3.5	4.0
Vt 150 S/L	Throw					
Neck Size 8" Ak 0.239	CFM	105	140	175	210	245
	Ps	0.016	0.029	0.046	0.066	0.090
	Throw	3.0	5.5	4.0	7.5	5.0
Vt 75 S/L	Throw	3.0	5.0	4.5	8.5	5.5
Vt 100 S/L	Throw	2.0	3.5	2.5	4.5	3.0
Vt 150 S/L	Throw					

Rezzin (four-way)

Neck Velocity		300	400	500	600	700
Neck Size 6" Ak 0.210	CFM	60	80	100	120	135
	Ps	0.001	0.002	0.003	0.005	0.006
	Throw	3.0	3.5	4.5	5.5	6.5
Vt 75	Throw					
Vt 100	Throw	1.5	2.5	3.0	3.5	4.0
Vt 150	Throw					
Neck Size 7" Ak 0.209	CFM	80	110	135	165	190
	Ps	0.003	0.005	0.008	0.011	0.015
	Throw	3.5	4.5	5.5	7.0	8.0
Vt 75	Throw	2.5	3.0	4.0	4.5	5.5
Vt 100	Throw					
Vt 150	Throw					
Neck Size 8" Ak 0.209	CFM	105	140	175	210	245
	Ps	0.005	0.008	0.013	0.018	0.025
	Throw	4.5	6.0	7.5	9.0	10.5
Vt 75	Throw	4.0	5.5	7.0	8.5	10.0
Vt 100	Throw	3.0	3.5	4.5	5.5	6.5
Vt 150	Throw					

Ceiling or Wall Effect

The tendency of an air stream moving along a wall or ceiling surface to remain in contact with that surface.

Core Area

The total plane area of that portion of a grille, face, or register bounded by a line tangent to the outer opening through which air can pass. The core area is less than the register size. Example, a 14-in. x 8-in. register may have a core that is 1 in. less than the listed size; so, the core area is 13in. x 7in. – 91 sq. in.

Diffuser

An outlet discharging supply air in a spreading pattern.

Diffusion

Distribution of air within a space by an outlet discharging supply air in a spreading pattern.

Drop

The vertical distance between the base of the outlet and the bottom of the air stream at the end of the horizontal throw.

Effective Area, Ak (Sq. Ft.)

The calculated area of an outlet based on the average measured velocity between the fins.

Envelope

The outer boundary of an air stream moving at a specific velocity (for example, a 50 fpm envelope).

Free Area

The total minimum area of the openings in the air outlet or inlet through which air can pass.

Grille

A louvered covering for an opening through which air passes.

Induction

The process of drawing room air into the projected air stream due to the velocity of the projected air stream (sometimes called aspiration).

Jet Velocity, Fpm (Face Velocity)

The average measured velocity of air passing between the fins.

Natural Convection Currents

Air currents created by a buoyancy effect caused by the difference in temperature between the room air and the air in contact with a warm or cold surface.

Outlet

Any opening through which air is delivered to condition a space.

Outlet Velocity, Fpm

The average velocity of the supply air, measured as it passes through the plane of the opening in the supply outlet.

Pressure Loss, WG

Indicates how much total pressure is required to move air through a register.

Primary Air

The mixture of supply air from the outlet and room air within the 1 50 fpm envelope.

Radius of Diffusion, Ft.

The horizontal distance (throw) from a ceiling diffuser to the point of terminal velocity.

Register

A grille which is equipped with a damper or control valve, and which directs air in a nonspreading jet.

Return

Any opening through which air is removed from a conditioned space.

Spread, Ft.

The maximum width of the total air stream at the point of terminal velocity.

Static Pressure, PS

The outward force of air within a duct measured in inches of water.

Stratification Boundary

The boundary between room air currents moving faster than 1 5 fpm and the stratification zone.

Stratified Zone

A region in which room air velocity is less than 1 5 fpm.

Temperature Differential

The temperature difference between the primary and the room air.

Temperature Variation (ΔT)

The temperature difference between points within the same space.

Terminal Velocity, Fpm

When the velocity of total air drops to 50 or 75 fpm, depending on the particular application, it reaches terminal velocity. Terminal velocity is not sharply defined for all applications.

Throw (Blow), Ft.

The horizontal distance an air stream travels after leaving a horizontal sidewall outlet before maximum velocity is reduced to terminal velocity. For a perimeter outlet, throw is the vertical distance the air stream travels before maximum velocity is reduced to terminal velocity.

Total Air

The mixture of projected air and room air set in motion by the supply air.

Total Pressure, Pt

The sum of the velocity and static pressures measured in inches of water.

Vane Ratio

The ratio showing depth of vane to minimum width between two adjacent vanes.

Velocity Pressure, Pv

The forward-moving force of air within a duct measured in inches of water.

NC Noise Criteria

A single number noise rating system that indicates what Broad Band, continuous sounds are reasonably acceptable.

A301	Steel (Stamped Aluminum) Curved Blade One-Way	12	39
A302	Steel (Stamped Aluminum) Curved Blade Two-Way	13	39
A303	Steel (Stamped Aluminum) Curved Blade Three-Way	13	39
A304	Steel (Stamped Aluminum) Curved Blade Four-Way	14	39
A501	Aluminum Square Diffuser One-Way, MS/OB	30	46
A502	Aluminum Square Diffuser Two-Way, MS/OB	30	46
A503	Aluminum Square Diffuser Three-Way, MS/OB	31	47
A504	Aluminum Square Diffuser Four-Way, MS/OB	31	47
A505	Aluminum Square Diffuser Four-Way Corner, MS/OB	31	47
A611	Stamped Aluminum Curved Blade Register One-Way, MS/OB	16	40
A612	Stamped Aluminum Curved Blade Register Two-Way, MS/OB	16	40
A613	Stamped Aluminum Curved Blade Register Three-Way, MS/OB	16	40
A614	Stamped Aluminum Curved Blade Register Four-Way, MS/OB	17	40
A618	Stamped Aluminum Straight Blade Register, MS/OB	17	40
A650	Stamped Steel/Aluminum Return Grille	18	42
A661	Stamped Steel/Aluminum Two-Way Register	20	43
A711	Stamped Aluminum One-Way, Sidewall/Ceiling Register MS	25	
A712	Stamped Aluminum Two-Way, Sidewall/Ceiling Register MS	25	
A713	Stamped Aluminum Three-Way, Sidewall/Ceiling Register MS	25	
A714	Stamped Aluminum Four-Way, Sidewall/Ceiling Register MS	25	
A718	Stamped Aluminum Straight Blade Register, MS	25	
HCAD	Access Door	27	
RZ-Round	Rezzin™ Plastic Round Ceiling Diffuser	32	48
RZ-Floor	Rezzin™ Plastic Two-Way Floor Diffuser	8	36
RZ-Square	Rezzin™ Plastic Square Ceiling Diffuser	32	48
RZ 2-Way	Rezzin™ Plastic Sidewall/Ceiling Register, Double Deflection	26	45
RZ 3-Way	Rezzin™ Plastic Sidewall/Ceiling Register, Three-Way Deflection	26	45
RZ 4-Way	Rezzin™ Plastic Sidewall/Ceiling Diffuser	26	45
11	Steel Duct Ring	28	
12	Steel Butterfly Damper with Ring	28	
16	Steel Round (Ceiling) Diffuser	28	46
21	Steel Square Mounting Frame	39	
210	Steel (Floor) Register	6	35
22	Steel Butterfly Damper with Mounting Frame	29	
23	Steel Opposed Blade Damper	30	
24	Steel Square (Ceiling) Diffuser	29	45
265	Steel (Floor) Return Grille	6	35
300M Series	Stamped Curved-Blade Register with Multi-Louver Damper	15	38
301	Steel (Stamped Aluminum) Curved Blade One-Way	12	38
302	Steel (Stamped Aluminum) Curved Blade Two-Way	12	38
303	Steel (Stamped Aluminum) Curved Blade Three-Way	13	38
304	Steel (Stamped Aluminum) Curved Blade Four-Way	14	38
350	Steel (Floor) Diffuser Powder Coat	7	36
406	Steel (Baseboard) Diffuser, 15" or 18"	9	37
407	Steel (Baseboard) Return Grille	9	
411	Steel (Floor) Diffuser	6	35
420	Steel Toe-Space Grille	7	36
421	Steel (Floor) Diffuser	7	36
462	Steel (Baseboard) Diffuser	9	37
464	Steel (Baseboard) Diffuser	9	37
531	Aluminum (Floor) Diffuser	7	36
631	Stamped Steel Three-Way Register	18	41
650	Stamped Steel/Aluminum Return Grille	18	41
651	Stamped Steel Register	19	41
654	Steel (Baseboard) Register	10	37

655	Steel (Baseboard) Register	10	37
657	Steel (Baseboard) Return Grille	10	37
658	Steel (Baseboard) Return Grille	11	37
659	Stamped Steel Filter Grille	19	41
661	Stamped Steel/Aluminum Two-Way Register	20	42
664	Steel (Baseboard) Register	11	37
672	Stamped Steel Return Grille	21	42
673	Stamped Steel Filter Grille	21	42
674	Steel (Baseboard) Return Grille	11	37
680M Series	Stamped Lanced-Blade Register with Multi-Louver Damper	24	43
681 (A681)	Stamped Steel One-Way Register	21	42
682 (A682)	Stamped Steel Two-Way Register	22	43
683 (A683)	Stamped Steel Three-Way Register	22	43
684 (A684)	Stamped Steel Four-Way Register	22	43
680-OB Series	Stamped Faced Opposed Blade Damper Registers	23	



Hart & Cooley, Inc.
5030 Corporate Exchange Blvd. SE
Grand Rapids, MI 49512

P (800) 433-6341
F (800) 223-8461

hartandcooley.com



GRILLES | REGISTERS | DIFFUSERS | FLEXIBLE AIR DUCT
VENT | CHIMNEY | ACCESS DOOR | FILTERS | DUCT COMPONENTS