

- KDT-0300A
- KYT-0300A



KT-0300 Ice Kube Machine



- Easy access to food zone with removal of two screws and lift-off door
- High-tech exterior with smudge and fingerprint resistant stainless-like finish
- White plastics in the food zone help identify areas needing cleaning
- Water shield, distribution tube, pump, floats, and trough removable by hand
- Available CleanAir™ pack controls the growth of bacteria and fungi that form slime and cause odors in the food zone

WARRANTY:

Ice Maker: 3 year Parts & Labor
 Evaporator: 5 year Parts & Labor
 Compressor: 5 year Parts 3 years Labor



HALF KUBE
 $\frac{3}{8}'' \times 1\frac{1}{8}'' \times \frac{7}{8}''$
 (.95 x 2.86 x 2.22 cm)

❄️ = 100%
 ⚡



KUBE
 $\frac{7}{8}'' \times \frac{7}{8}'' \times \frac{7}{8}''$
 (2.22 x 2.22 x 2.22 cm)

❄️ = 100%
 ⚡

R410A Refrigerant



Koolaire KT0300 Ice Kube Machine on a K-400 bin.

KT-0300
 ICE KUBE MACHINE













By MANITOWOC

2110 SOUTH 26TH ST | MANITOWOC, WI 54220 USA | 1-920-682-0161 [www.kool-aire.com]









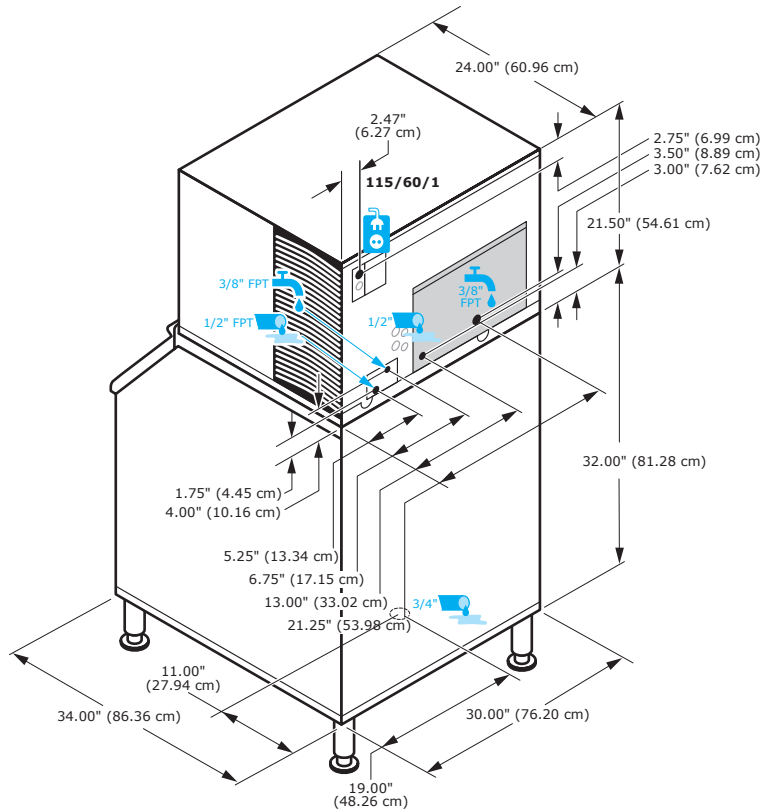

KT-0300

ICE KUBE MACHINE

| | | | | | | | |
|---|---|---|--|-------------------------------|---|---|---|
|  |  |  |  | |  |  |  |
| | | | 70°/50° F 21°/10° C | 90°/70° F 32°/21° C | [kWh/ 100 lbs ice] | [gal/100 lbs ice] | |
| KDT-0300A |  |  | 333 lbs | 230 lbs | 5.9 | 19 | • |
| | | | 151 kg | 104 kg | | | |
| KYT-0300A |  |  | 330 lbs | 230 lbs | 5.9 | 19 | • |
| | | | 150 kg | 104 kg | | | |



| | | |
|---|---|---|
|  |  |  |
| Minimum | | Maximum |
| 40°F 4.4°C |  | 110°F 43.3°C |
| 40°F 4.4°C |  | 90°F 32.2°C |
| 20psi 138 kPa |  | 80psi 551 kPa |
|  9.4 | A | |
| |  | 15 Amps |

137 lbs 62 kg 

Popular Accessories

| | | | |
|---|---|----------------------------------|---------------------------|
| Artic Pure Water Filters AR-Pre & AR 10000 | Dispenser Bin Thermostat Kit K-00457 | Top Air Discharge Kit K-00379 | Clean Air Pack K-00206 |
|---|---|----------------------------------|---------------------------|

KOOLAIRE

By  MANITOWOC

2110 SOUTH 26TH ST | MANITOWOC, WI 54220 USA | 1-920-682-0161 [www.kool-aire.com]