

- KDT-0400A
- KYT-0400A
- KDT-0400W
- KYT-0400W



KT-0400 Ice Kube Machine



- Easy access to food zone with removal of two screws and lift-off door
- High-tech exterior with smudge and fingerprint resistant stainless-like finish
- White plastics in the food zone help identify areas needing cleaning
- Water shield, distribution tube, pump, floats, and trough removable by hand
- Available CleanAir™ pack controls the growth of bacteria and fungi that form slime and cause odors in the food zone

WARRANTY:
 Ice Maker: 3 year Parts & Labor
 Evaporator: 5 year Parts & Labor
 Compressor: 5 year Parts & 3 year Labor

KT-0400
 ICE KUBE MACHINE



HALF KUBE
 $\frac{3}{8}'' \times 1\frac{1}{8}'' \times \frac{7}{8}''$
 (.95 x 2.86 x 2.22 cm)
 $\frac{\text{ice}}{\text{water}} = 100\%$



KUBE
 $\frac{7}{8}'' \times \frac{7}{8}'' \times \frac{7}{8}''$
 (2.22 x 2.22 x 2.22 cm)
 $\frac{\text{ice}}{\text{water}} = 100\%$

R410A Refrigerant



Koolaire KT0400 Ice Kube Machine on a K400 bin.











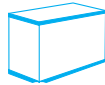







By **MANITOWOC**









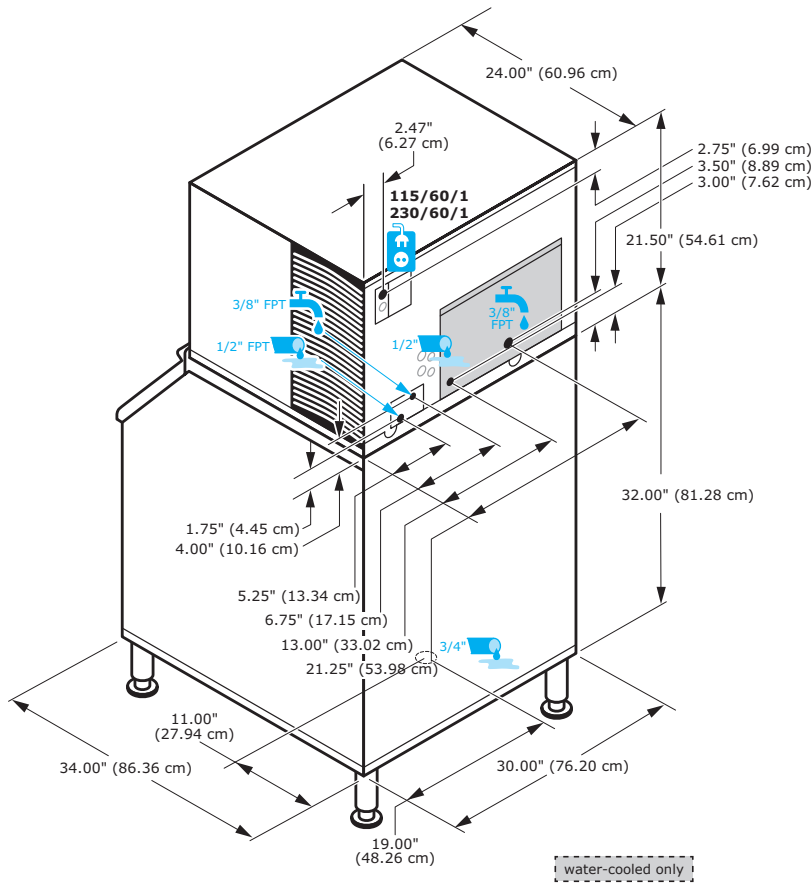



2110 SOUTH 26TH ST | MANITOWOC, WI 54220 USA | 1-920-682-0161 | www.kool-aire.com



KT-0400 ICE KUBE MACHINE

				 				
				70°/50° F 21°/10° C	90°/70° F 32°/21° C	[kWh/ 100 lbs ice]	[gal/100 lbs ice]	
KDT-0400A			440 lbs	345 lbs	6.1	19	•	
			199 kg	156 kg				
KYT-0400A			450 lbs	350 lbs	5.6	19	•	
			204 kg	159 kg				
KDT-0400W			425 lbs	360 lbs	4.6	19		
			193 kg	163 kg				
KYT-0400W			422 lbs	360 lbs	4.7	19		
			191 kg	163 kg				



				
Minimum			Maximum	
40°F			110°F	
4.4°C			43.3°C	
40°F			90°F	
4.4°C			32.2°C	
20psi			80psi	
138 kPa			551 kPa	
 12.1				
 11.4				
			20 Amps	
 153 lbs		69 kg		
 147 lbs		67 kg		

Water cooled condenser water usage/100 lbs. or 45.4 kg. of ice : 160 gals. /606 L.

Popular Accessories

Artic Pure Water Filters	Dispenser Bin Thermostat Kit	Top Air Discharge Kit	Clean Air Pack
AR-Pre & AR 10000	K-00457	K-00379	K-00206

KOOLAIRE

By  MANITOWOC

2110 SOUTH 26TH ST | MANITOWOC, WI 54220 USA | 1-920-682-0161 [www.kool-aire.com]