

INDIGO[®] NXT

Air/Water/Remote Condenser
Ice Machines

Technician's Handbook



Safety Notices

Read these precautions to prevent personal injury:

- Read this manual thoroughly before operating, installing or performing maintenance on the equipment. Failure to follow instructions in this manual can cause property damage, injury or death.
- Routine adjustments and maintenance procedures outlined in this manual are not covered by the warranty.
- Proper installation, care and maintenance are essential for maximum performance and trouble-free operation of your equipment.
- Visit our website www.manitowocice.com for manual updates, translations, or contact information for service agents in your area.

This equipment contains high voltage electricity and refrigerant charge. Installation and repairs are to be performed by properly trained technicians aware of the dangers of dealing with high voltage electricity and refrigerant under pressure. The technician must also be certified in proper refrigerant handling and servicing procedures. All lockout and tag out procedures must be followed when working on this equipment.

- This equipment is intended for indoor use only. Do not install or operate this equipment in outdoor areas.
- As you work on this equipment, be sure to pay close attention to the safety notices in this handbook. Disregarding the notices may lead to serious injury and/or damage to the equipment.

DEFINITIONS

DANGER

Indicates a hazardous situation that, if not avoided, will result in death or serious injury. This applies to the most extreme situations.

Warning

Indicates a hazardous situation that, if not avoided, could result in death or serious injury.

Caution

Indicates a hazardous situation that, if not avoided, could result in minor or moderate injury.

Notice

Indicates information considered important, but not hazard-related (e.g. messages relating to property damage).

NOTE: Indicates useful, extra information about the procedure you are performing.

Warning

Follow these electrical requirements during installation of this equipment:

- All field wiring must conform to all applicable codes of the authority having jurisdiction. It is the responsibility of the end user to provide the disconnect means to satisfy local codes. Refer to rating plate for proper voltage.
- This appliance must be grounded.
- This equipment must be positioned so that the plug is accessible unless other means for disconnection from the power supply (e.g., circuit breaker or disconnect switch) is provided.
- Check all wiring connections, including factory terminals, before operation. Connections can become loose during shipment and installation.

Warning

Follow these precautions to prevent personal injury during installation of this equipment:

- Installation must comply with all applicable equipment fire and health codes with the authority having jurisdiction.
- Connect to a potable water supply only.
- To avoid instability the installation area must be capable of supporting the combined weight of the equipment and product. Additionally the equipment must be level side to side and front to back.
- Remove all removable panels before lifting and installing and use appropriate safety equipment during installation and servicing. Two or more people are required to lift or move this appliance to prevent tipping and/or injury.
- Do not damage the refrigeration circuit when installing, maintaining or servicing the unit.
- This equipment contains refrigerant charge. Installation of the line sets must be performed by a properly trained and EPA certified refrigeration technician aware of the dangers of dealing with refrigerant charged equipment.
- Ice machines require a deflector when installed on an ice storage bin. Prior to using a non-OEM ice storage system with this ice machine, contact the bin manufacturer to assure their ice deflector is compatible.
- Prior to installing a non-OEM ice storage system with this ice machine, follow the manufacturers installation procedures and verify the location and installation meets the local/national mechanical codes and stability requirements.

Warning

Follow these precautions to prevent personal injury while operating or maintaining this equipment:

- Refer to nameplate to identify the type of refrigerant in your equipment.
- Only trained and qualified personnel aware of the dangers are allowed to work on the equipment.
- Read this manual thoroughly before operating, installing or performing maintenance on the equipment. Failure to follow instructions in this manual can cause property damage, injury or death.
- Crush/Pinch Hazard. Keep hands clear of moving components. Components can move without warning unless power is disconnected and all potential energy is removed.
- Moisture collecting on the floor will create a slippery surface. Clean up any water on the floor immediately to prevent a slip hazard.
- Never use sharp objects or tools to remove ice or frost. Do not use mechanical devices or other means to accelerate the defrosting process.
- When using cleaning fluids or chemicals, rubber gloves and eye protection (and/or face shield) must be worn.

Warning

Follow these precautions to prevent personal injury while operating or maintaining this equipment:

- Objects placed or dropped in the bin can affect human health and safety. Locate and remove any objects immediately.
- Never use sharp objects or tools to remove ice or frost.
- Do not use mechanical devices or other means to accelerate the defrosting process.
- When using cleaning fluids or chemicals, rubber gloves and eye protection (and/or face shield) must be worn.
- Some models may contain R290 (propane) refrigerant. R290 (propane) is flammable in concentrations of air between approximately 2.1% and 9.5% by volume (LEL lower explosion limit and UEL upper explosion limit). An ignition source at a temperature higher than 875°F (470°C) is needed for a combustion to occur. Refer to nameplate to identify the type of refrigerant in your equipment. Only trained and qualified personnel aware of the dangers are allowed to work on the equipment.

DANGER

Do not operate equipment that has been misused, abused, neglected, damaged, or altered/modified from that of original manufactured specifications. This appliance is not intended for use by persons (including children) with reduced physical, sensory or mental capabilities, or lack of experience and knowledge, unless they have been given supervision concerning use of the appliance by a person responsible for their safety. Do not allow children to play with, clean or maintain this appliance without proper supervision.

Warning

Follow these precautions to prevent personal injury during use and maintenance of this equipment:

- It is the responsibility of the equipment owner to perform a Personal Protective Equipment Hazard Assessment to ensure adequate protection during maintenance procedures.
- Do Not Store Or Use Gasoline Or Other Flammable Vapors Or Liquids In The Vicinity Of This Or Any Other Appliance. Never use flammable oil soaked cloths or combustible cleaning solutions for cleaning.
- All covers and access panels must be in place and properly secured when operating this equipment.
- Risk of fire/shock. All minimum clearances must be maintained. Do not obstruct vents or openings.
- Failure to disconnect power at the main power supply disconnect could result in serious injury or death. The power switch DOES NOT disconnect all incoming power.
- All utility connections and fixtures must be maintained in accordance with the authority having jurisdiction.
- Turn off and lockout all utilities (gas, electric, water) according to approved practices during maintenance or servicing.

DANGER

Follow these precautions to prevent personal injury during use and maintenance of this equipment:

- Units with two power cords must be plugged into individual branch circuits. During movement, cleaning or repair it is necessary to unplug both power cords.
- Never use a high-pressure water jet for cleaning on the interior or exterior of this unit. Do not use power cleaning equipment, steel wool, scrapers or wire brushes on stainless steel or painted surfaces.
- Two or more people are required to move this equipment to prevent tipping.
- Locking the front casters after moving is the owner's and operator's responsibility. When casters are installed, the mass of this unit will allow it to move uncontrolled on an inclined surface. These units must be tethered/secured to comply with all applicable codes.
- The on-site supervisor is responsible for ensuring that operators are made aware of the inherent dangers of operating this equipment.
- Do not operate any appliance with a damaged cord or plug. All repairs must be performed by a qualified service company.

Table of Contents

Safety Notices	3
Definitions	4
General Information	
Model Nomenclature	17
Ice Cube Sizes	18
Model/Serial Number Location	18
Model Numbers	19
Ice Machine Warranty Information	20
LuminIce® II	21
Installation	
Location of Ice Machine	23
Clearance Requirements	24
Air, Water, Remote Condenser Models	24
Ice Machine Heat of Rejection	25
Installation on a Bin	26
Ice Machine on a Dispenser Installation	26
Water Supply and Drains	27
Line Set Applications	28
Remote Condenser	29
Remote Ice Machine Usage with Non-Manitowoc Multi-Circuit Condensers	32
Operation	
Operational Checks	35
General	35
Ice Thickness Check	36
Sequence of Operation	38
Self Contained Air or Water Cooled	38
Energized Parts Chart Self Contained Models	42
Remote Condenser	45
Energized Parts Chart Remote Models	49

Maintenance

Cleaning and Sanitizing	53
iAuCS®	54
Touchscreen Operation For The Clean Cycle	55
Starting a Clean Cycle	55
Water Curtain/Damper Operation During the Clean Cycle	55
Pausing a Clean Cycle	55
Power Interruption During Clean Cycle	55
Aborting a Clean Cycle	55
Cleaning Procedure	56
Sanitizing Procedure	61
Preventative Maintenance Cleaning Procedure ..	65
Removal from Service/Winterization	67
Air-Cooled Ice Machines	67
Water-Cooled Ice Machines	68

Troubleshooting

Troubleshooting	69
Long Freeze Cycle	69
Long Harvest Cycle	69
Safe Operation Mode	70
Remove Ice Cycle	71
Analyzing Why a Service Fault (E01 & E02) Stopped the Ice Machine	72
E01 Long Freeze	73
E02 Long Harvest	74
Troubleshooting By Symptom	75
Reset to Factory Defaults	76
Symptom #1 - Ice Machine Will Not Run	77
Symptom #2 - Freeze Cycle Refrigeration System Operational Analysis Tables	82
Symptom #3 & #4 - Harvest Problems Self-Contained Air, Water & Remote Condenser Models	111
Symptom #3 - Self-Contained Air or Water-cooled	112
Symptom #3 - Remote Condenser	114
Symptom #4 - Self-Contained Air, Water-Cooled or Remote	116

Controls

Touch Screen Features	119
Home Screen Icon Descriptions	121
Setup Wizard	122
Menu Navigation Overview	123
Settings Menu Screen Navigation	123
Event Log	128
Event Log Detail	129
USB Flash Drive Specifications and Formatting	133
Upgrading Firmware with a Flash Drive . . .	134
Exporting Data to a Flash Drive	135

Component Check Procedures

Electrical Components	137
Control Board, Display and Touchscreen. . .	137
Control Board Relay Test.	140
Programming a Replacement Control Board	141
Main Fuse	142
Bin Switch	143
Water Level Control Circuitry	146
Ice Thickness Probe (Initiates Harvest) . . .	149
High Pressure Cutout (HPCO) Control	153
Fan Cycle Control.	156
Thermistors	157
Harvest Assist Air Pump	161
Compressor Electrical Diagnostics	162
Diagnosing Start Components	164
Refrigeration Components	167
Headmaster	167
Harvest Pressure Regulating (HPR) System Remote Condenser Only	171
Water Regulating Valve.	174
Refrigerant Recovery/Evacuation	175
Definitions	175
Refrigerant Re-Use Policy	176
Self-Contained Model Procedure	178
Remote Condenser Model Procedure	181

System Contamination Clean-Up	185
Determining Severity of Contamination	185
Cleanup Procedure	187
Liquid Line Filter-Driers	191
Replacing Pressure Controls Without Removing Refrigerant Charge	192
Total System Refrigerant Charge	193

Charts

Cycle Times/24-Hour Ice Production/Refrigerant Pressure Charts	195
IF0300 Series	196
IT0420 Series	198
IT0450 Series	200
IT0500 Series	202
IF0600 Series	205
IT0620 Series	208
IF0900 Series	210
IT1200 Series	213
IT1500 Series	216
IT1900 Series	219

Diagrams

Wiring Diagrams	223
Wiring Diagram Legend	223
IT0420/IT0450/IT0500/IT0620 - 1ph Air/Water	224
IT0500 - 1ph Remote Air-Cooled	226
IT1200/IT1500/IT1900 - 1ph Air/Water.	228
IT1200/IT1500/IT1900 - 3ph Air/Water.	230
IT1200/IT1500/IT1900 - 1ph Remote	232
IT1200/IT1500/IT1900 - 3ph Remote Condenser	234
Electronic Control Board	236
Electrical Noise Filter	238
Refrigeration Tubing Schematics	239
Self-Contained Air or Water-Cooled	239
Remote Air-Cooled Condenser Models	242

THIS PAGE INTENTIONALLY LEFT BLANK

General Information

Model Nomenclature

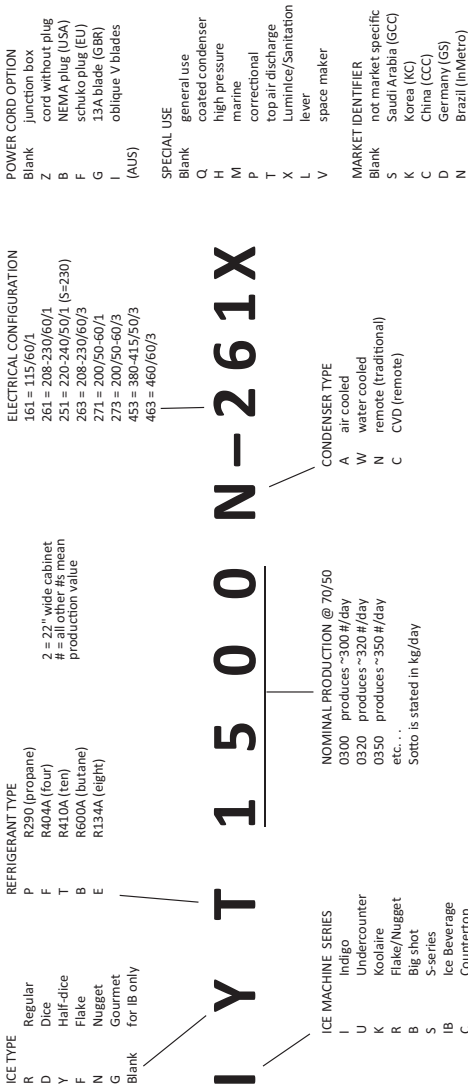

Ice Cube Sizes

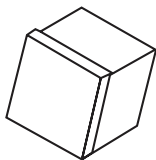

Regular

1-1/8" x 1-1/8" x 7/8"
2.86 x 2.86 x 2.22 cm

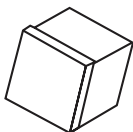

Dice

7/8" x 7/8" x 7/8"
2.22 x 2.22 x 2.22 cm

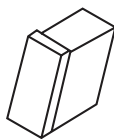

Half Dice

3/8" x 1-1/8" x 7/8"
0.95 x 2.86 x 2.22 cm

Notice

All Manitowoc ice machines require the ice storage system (bin, dispenser, etc.) to incorporate an ice deflector.

Prior to using a non-Manitowoc ice storage system with other Manitowoc ice machines, contact the manufacturer to assure their ice deflector is compatible with Manitowoc ice machines.

Model/Serial Number Location

These numbers are required when requesting information from your local Manitowoc Distributor, service representative, or Manitowoc Ice.

- The model and serial number can be viewed by pressing the information icon on the touchscreen.
- The owner warranty registration card.
- The model/serial number data plate located in the evaporator compartment and on the back of the ice machine.

The model and serial number displayed on the touchscreen must match the data plate for proper operation.

Model Numbers

Air-Water-Remote Condenser Models

Self-Contained Air-Cooled	Self-Contained Water-Cooled	Remote
IDF0300A IYF0300A	IDF0300W IYF0300W	---- ----
IDT0420A IYT0420A	IDT0420W IYT0420W	---- ----
IDT0450A IYT0450A	IDT0450W IYT0450W	---- ----
IDT0500A IYT0500A IRT0500A	IDT0500W IYT0500W IRT0500W	IDT0500N IYT0500N ----
IDF0600A IYF0600A	IDF0600W IYF0600W	IDF0600N IYF0600N
IDT0620A IYT0620A IRT0620A IDP0620A	IDT0620W IYT0620W IRT0620W ----	---- ---- ---- ----
IDT1200A IYT1200A	IDT1200W IYT1200W	IDT1200N IYT1200N
IDT1500A IYT1500A	IDT1500W IYT1500W	IDT1500N IYT1500N
IDT1900A IYT1900A IRT1900A	IDT1900W IYT1900W ----	IDT1900N IYT1900N IRT1900N

NOTE: Additional designators are used to identify Voltage, Specials or Country specific models - See "Model Nomenclature" on page 17

Ice Machine Warranty Information

For warranty information visit:

<http://www.manitowocice.com/Service/Warranty>

- Warranty Verification
- Warranty Registration
- View and download a copy of the warranty Owner Warranty Registration Card

Warranty coverage begins the day the ice machine is installed.

LuminIce® II

The LuminIce® growth inhibitor recirculates the air in the ice machine foodzone over a UV bulb. This process will inhibit the growth of common micro-organisms on all exposed foodzone surfaces.

- LuminIce® bulbs require replacement on a yearly basis.
- The control board can be set to automatically display a reminder after 12 months.

NOTE: LuminIce® and LuminIce® II bulbs are not interchangeable; verify your model before ordering a replacement bulb.

Cleanup Procedure for Accidental Bulb Breakage

The cleanup procedure is identical to the procedure used to clean up compact fluorescent (CFL) or fluorescent tube lights. These lights contain a small amount of mercury sealed within a glass tube. Breaking these types of lights will release mercury and mercury vapor. The broken bulb can continue to release mercury vapor until it is cleaned up and removed.

The latest EPA procedures can be viewed on their website at www.epa.gov/cfl/cflcleanup.html.

NOTE: LuminIce® and LuminIce® II bulbs are not interchangeable; verify your model before ordering a replacement bulb. LuminIce® bulbs have a white base and LuminIce® II bulbs have a blue base.

THIS PAGE INTENTIONALLY LEFT BLANK

Installation

Location of Ice Machine

The location selected for the ice machine must meet the following criteria. If any of these criteria are not met, select another location.

- The location must be free of airborne and other contaminants.
- Self contained air and water cooled - The air temperature must be at least 35°F (1.6°C), but must not exceed 110°F (43.4°C).
- Remote air cooled - The air temperature must be at least -20°F (-29°C), but must not exceed 120°F (49°C).
- Ice Making Water Inlet - Water Pressure must be at least 20 psi (1.4 bar), but must not exceed 80 psi (5.5 bar).
- Condenser Water Inlet - Water Pressure must be at least 20 psi (1.4 bar), but must not exceed 276 psi (19 bar).
- The location must not be near heat-generating equipment or in direct sunlight and protected from weather.
- The location must not obstruct air flow through or around the ice machine. Refer to chart below for clearance requirements.
- The ice machine must be protected if it will be subjected to temperatures below 32°F (0°C). Failure caused by exposure to freezing temperatures is not covered by the warranty. See “Removal from Service/ Winterization”.

Clearance Requirements

AIR, WATER, REMOTE CONDENSER MODELS

IF0300	Self-Contained Air-Cooled	Water-Cooled
Top/Sides	16" (40 cm)	8" (20 cm)
Back	5" (13 cm)	5" (13 cm)

IT0420 IT0450 IT0500 IT0620	Self-Contained Air-Cooled	Water-Cooled and Remote
Top/Sides	12" (30.5 cm)	8" (20.3 cm)
Back	5" (12.7 cm)	5" (12.7 cm)

IF0900	Self-Contained Air-Cooled	Water-Cooled and Remote
Top/Sides	8" (20.3 cm)	8" (20.3 cm)
Back	5" (13 cm)	5" (13 cm)

IT1200	Self-Contained Air-Cooled	Water-Cooled and Remote
Top	8" (20.3 cm)	8" (20.3 cm)
Sides	12" (30.5 cm)	8" (20.3 cm)
Back	5" (12.7 cm)	5" (12.7 cm)

IT1500	Self-Contained Air-Cooled	Water-Cooled and Remote
Top	12" (30.5 cm)	8" (20.3 cm)
Sides	8" (20.3 cm)	8" (20.3 cm)
Back	12" (30.5 cm)	5" (12.7 cm)

IT1900	Self-Contained Air-Cooled	Water-Cooled and Remote
Top/Sides	24" (61.0 cm)	8" (20.3 cm)
Back	12" (30.5 cm)	5" (12.7 cm)

Ice Machine Heat of Rejection

Series Ice Machine	Heat of Rejection	
	Air Conditioning*	Peak
IF0300	4600	5450
IT0420	3800	6000
IT0450	5400	6300
IT0500	6100	6900
IF0600	9000	13900
IT0620	9000	13900
IF0900	13000	16000
IT1200	20700	24500
IT1500	23500	27000
IT1900	31000	36000

*BTU/Hour

Because the heat of rejection varies during the ice making cycle, the figure shown is an average.

Top Air Discharge Kit

The top air discharge kit can be used on select ice machine models. This kit directs warm exhaust air upward rather than out the side panels. Contact your local distributor for details.

Installation on a Bin

An ice deflector is required for all bin installations and is included with all Manitowoc bins. Order the appropriate deflector kit (30" or 48") for any bin without a deflector.

NOTE: An optional safety kit is available to attach the ice machine to D model bins. Contact your local distributor for details.

Warning

PERSONAL INJURY POTENTIAL

Do not operate any ice machine with the deflector removed.

Ice Machine on a Dispenser Installation

Observe following recommendations unless required by the dispenser manufacturer.

- An adapter is not required for ice machines that match the dispenser size.
- A deflector is not required.
- Ice level management is recommended to prevent water leakage or movement of ice machine during agitation. A dispenser baffle is required to prevent ice from contacting the ice machine door and prevent possible water leakage.
- Align sides and back of ice machine with sides and back of dispenser when placing ice machine.
- Follow ice machine installation procedures in this manual and any additional installation requirements specified by the dispenser manufacturer.

Water Supply and Drains

Potable Water

- Water temperature must be between 40°F (4.4°C) and 90°F (32°C).
- Water pressure must be between 20 psi (140 kPa) and 80 psi (550 kPa).
- Minimum internal diameter of tubing 3/8" (10 mm).

Drain Connections

- Drain lines must have a 1.5 inch drop per 5 feet (2.5 cm per meter) of run and must not create traps.
- The floor drain must be large enough to accommodate drainage from all drains.
- Run separate bin and ice machine drain lines.
- Insulate drain lines to prevent condensation.
- Vent the ice machine drain to the atmosphere.
- Drain termination must have an air gap that meets local code.

Line Set Applications

Notice

The 60-month compressor warranty (including the 36-month labor replacement warranty) will not apply if the Manitowoc Ice Machine, Condenser or QuietQube® Condensing Unit were not installed according to specifications. This warranty also will not apply if the refrigeration system is modified with a condenser, heat reclaim device, or other parts or assemblies not manufactured by Manitowoc Ice. Or refrigeration system additives such as leak detection dyes, inhibitors or non OEM approved chemicals.

Warning

Recovery locations vary by model. Verify you are making the correct connections for your model to prevent accidental release of high pressure refrigerant.

Important

Manitowoc remote systems are only approved and warranted as a complete new package. Warranty on the refrigeration system will be void if new equipment is connected to existing (used) tubing, remote condenser, remote condensing unit or ice machine head section.

REMOTE CONDENSER

Ice Machine	Remote Single Circuit Condenser	Line Set*
IT0500N	JCT0500	RT-20-R410A RT-35-R410A RT-50-R410A
IF0600N IF0900N	JCF0900	RT-20-R404A RT-35-R404A RT-50-R404A
IT1200N	JCT1200	RT-20-R410A RT-35-R410A RT-50-R410A
IT1500N IT1900N	JCT1500	RL-20-R410A RL-35-R410A RL-50-R410A

*Line Set	Discharge Line	Liquid Line
RT	1/2" (1.27 cm)	5/16" (.79 cm)
RL	1/2" (1.27 cm)	3/8" (.95 cm)

R404A line sets have white protective caps.

R410A line sets have pink protective caps.

Air Temperature Around the Condenser	
Minimum	Maximum
-20°F (-29°C)	120°F (49°C)

Additional Refrigerant Charge For 51' to 100' Line Sets

Ice Machine	Condenser	Additional Amount of Refrigerant To Be Added To Nameplate Charge
IT0500N	JCT0500	1.5 lbs - 680 g
IT1200N	JCT1200	2.0 lbs - 907 g
IF0600N	JCF0900	1.5 lbs - 680 g
IF0900N	JCF0900	2.0 lbs - 907 g
IT1500N	JCT1500	2.0 lbs - 907 g
IT1900N	JCT1500	2.0 lbs - 907 g

Calculating Allowable Line set Distance

Line Set Length

The maximum length is 100' (30.5 m).

Line Set Rise/Drop

The maximum rise is 35' (10.7 m).

The maximum drop is 15' (4.5 m).

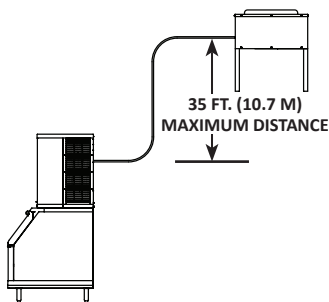

35 ft. (10.7 m) Rise: The maximum distance the Condenser or Condensing Unit can be above the ice machine.

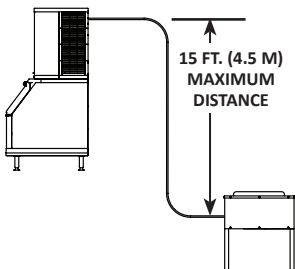

15 ft. (4.5 m) Drop: The maximum distance the Condenser or Condensing Unit can be below the ice machine.

Calculated Line Set Distance

The maximum calculated distance is 150' (45.7 m).

Line set rises, drops, horizontal runs (or combinations of these) in excess of the stated maximums will exceed compressor start-up and design limits. This will cause poor oil return to the compressor.

Make the following calculations to make sure the line set layout is within specifications.

1. Insert the **measured rise** into the formula below. Multiply by 1.7 to get the calculated rise.
(Example: A condenser located 10 feet above the ice machine has a **calculated rise** of 17 feet.)
2. Insert the **measured drop** into the formula below. Multiply by 6.6 to get the calculated drop.
(Example. A condenser located 10 feet below the ice machine has a **calculated drop** of 66 feet.)
3. Insert the **measured horizontal distance** into the formula below. No calculation is necessary.
4. Add together the **calculated rise, calculated drop, and horizontal distance** to get the **total calculated distance**. If this total exceeds 150' (45.7 m), move the condenser to a new location and perform the calculations again.

Maximum Line set Distance Formula

Measured Rise ____ X 1.7 = ____ Calculated Rise
(35 ft. Max)

Step 1

Measured Drop ____ X 6.6 = ____ Calculated Drop
(15 ft. Max.)

Step 2

Measured Horizontal Distance = _____ Horizontal
(100 ft. Max.) Distance

Step 3

Total Calculated Distance = _____ Total Calculated
(150 ft. Max.) Distance

Remote Ice Machine Usage with Non-Manitowoc Multi-Circuit Condensers

Warranty

The sixty (60) month compressor warranty, including thirty six (36) month labor replacement warranty, shall not apply when the remote ice machine is not installed within the remote specifications. The foregoing warranty shall not apply to any ice machine installed and/or maintained inconsistent with the technical instructions provided by Manitowoc Ice. Performance may vary from Sales specifications. ARI certified standard ratings only apply when used with a Manitowoc remote condenser.

If the design of the condenser meets the specifications, Manitowoc's only approval is for full warranty coverage to be extended to the Manitowoc manufactured part of the system. Since Manitowoc does not test the condenser in conjunction with the ice machine, Manitowoc will not endorse, recommend, or approve the condenser, and will not be responsible for its performance or reliability.

Important

Manitowoc warrants only complete new and unused remote packages. Guaranteeing the integrity of a new ice machine under the terms of our warranty prohibits the use of pre-existing (used) tubing or condensers.

Design & Burst Pressure

Design Pressure 600 psig - 4137 kPa

Burst Pressure 2500 psig - 17237 kPa

Head Pressure Control Valve

Do not use a fan cycling control to try to maintain discharge pressure. Compressor failure will result. Any remote condenser connected to a Manitowoc Ice Machine must have the OEM head pressure control valve installed. Manitowoc will not accept substitute “off the shelf” head pressure control valves.

Fan Motor

The condenser fan must be on during the complete ice machine freeze cycle (do not cycle on fan cycle control). The ice maker has a condenser fan motor circuit for use with a Manitowoc condenser. It is recommended that this circuit be used to control the condenser fan(s) on the multi-circuit condenser to assure it is on at the proper time. Do not exceed the rated amps for the fan motor circuit listed on the ice machine’s serial tag.

Internal Condenser Volume

The multi-circuit condenser internal volume must not be less than or exceed that used by Manitowoc. Do not exceed internal volume and try to add charge to compensate, as compressor failure will result.

Model	Minimum	Maximum
IT0500N	0.020	0.030
IF0600/IT1200N	0.045	0.060
IT1500N/IT1900N	0.085	0.105

Heat of Rejection

Model	Peak	Average
IT0500N	6100	6900
IF0600	9000	13900
IT1200N	20700	24500
IT1500N	23000	27000
IT1900N	26100	30500

Refrigerant Charge

The ice machine model/serial tag lists the refrigerant amount. Remote condensers and line sets contain a vapor charge only.

Model	Amount	Type
IT0500N	6.0 lbs - 2.72 kg	R410A
IF0600	6.5 lbs - 2.95 kgs	R404A
IT1200N	7.5 lbs - 3.40 kg	R410A
IT1500N	7.0 lbs - 3.18 kg	R410A
IT1900N	8.0 lbs - 3.63 kg	R410A

Quick Connect Fittings

The ice machine and line sets come with quick connect fittings. It is recommended that matching quick connects (available through Manitowoc Distributors K00129) be installed in the multi-circuit condenser, and that a vapor “holding” charge, 5 oz. (150 ml), of proper refrigerant be added to the condenser prior to connection of the ice machine or line set to the condenser.

Operation

Operational Checks

GENERAL

Manitowoc ice machines are factory-operated and adjusted before shipment. Normally, new installations do not require any adjustment.

To ensure proper operation, always follow the Operational Checks:

- when starting the ice machine for the first time
- after a prolonged out of service period
- after cleaning and sanitizing

NOTE: Routine adjustments and maintenance procedures are not covered by the warranty.

Important

Refrigeration compressors must be operated for a minimum break in period of 24 hours before full ice production will be reached.

ICE THICKNESS CHECK

The ice thickness probe is factory-set to maintain the ice bridge thickness at 1/8" (3 mm).

NOTE: Make sure the water curtain/splash shields are in place when performing this check. It prevents water from splashing out of the water trough. Remove the curtain to make an adjustment, then replace immediately after the adjustment is made.

1. Inspect the bridge connecting the cubes. It should be 1/8" (3 mm) thick.
2. If adjustment is necessary, turn the ice thickness probe adjustment screw clockwise to increase bridge thickness or counterclockwise to decrease bridge thickness. Set a 9/32" gap between the ice thickness probe and evaporator as a starting point. Then adjust to achieve 1/8" ice thickness.
3. Make sure the ice thickness probe wire and the bracket do not restrict movement of the probe.

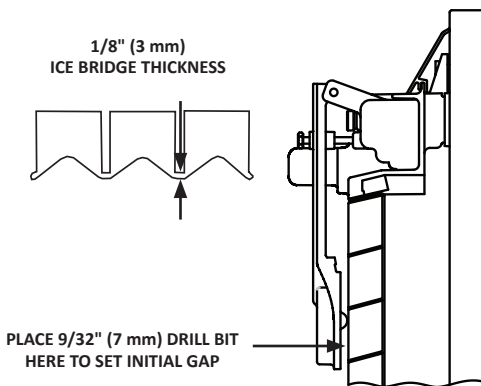

Ice Thickness Check

NOTE: Turning the adjustment 1/3 of a turn will change the ice thickness about 1/16" (1.5 mm). Make adjustment only when the ice machine is off to prevent initiating a harvest.

Control Board Timers

The control board has the following non-adjustable timers:

- The ice machine is locked into the freeze cycle for 6 minutes before the ice thickness probe can initiate a harvest cycle.
- The maximum freeze time is 35 minutes at which time the control board automatically initiates a harvest sequence.
- The maximum harvest time is 7 minutes, the control board will preform a remove ice cycle and then return the ice machine to the freeze cycle.
- Maximum water fill time in the freeze cycle:
 - Single evaporator 6 minutes.
 - Dual evaporator 8 minutes.

Sequence of Operation

SELF CONTAINED AIR OR WATER COOLED

NOTE: The power button must be depressed and the water curtain/ice dampers must be in place on the evaporator before the ice machine will start.

Initial Start-Up or Start-Up After Automatic Shut-Off

1. Water Purge

Before the compressor starts, the water pump and water dump solenoid energize to purge the ice machine of old water. This feature ensures that the ice making cycle starts with fresh water.

2. Refrigeration System Equalization and Start-Up

The harvest valve(s) and air pump(s) energize to equalize high and low side refrigeration pressure.

After 5 seconds the contactor energizes the compressor and supplies power to the condenser fan motor. After 5 seconds the harvest valve(s) and air pump(s) de-energize.

NOTE: The fan motor is wired through a fan cycle pressure control. When the discharge pressure exceeds the cut in pressure the fan cycle switch closes and energizes the fan motor.

Freeze Sequence

3. Prechill

The compressor is on for 30 seconds (120 seconds initial cycle) to lower the temperature of the evaporator(s) before the water pump is energized. The water fill valve will energize and remain on until water touches the low and high, water level probes.

4. Freeze

Water Pump

The water pump(s) energizes and water flows over the evaporator. The water pump is energized throughout the freeze cycle.

Water Inlet Valve

The water inlet valve energized in prechill (30 seconds) and will energize one more time in the freeze cycle. The control board will prevent the water fill valve from energizing after a 6 minute water fill time limit.

After water contacts the low and high water probes the water fill valve de-energizes. Ice builds on the evaporator and the water level drops. When water loses contact with the high water probe, the water fill valve energizes until water contacts the high water probe again.

Ice Thickness Probe

The freeze cycle continues until the six minute freeze lock expires and enough ice has formed to send a signal from the ice thickness probe to the control board.

During the first 6 minutes of the freeze cycle the ice thickness probe microphone samples ambient noise. 6 minutes into the freeze cycle baseline readings are recorded. Ice formation on the evaporator will change the readings; when the baseline readings are exceeded a harvest cycle starts.

Harvest Sequence

5. Water Purge

The air pump(s) (when used) and the harvest valve(s) open at the beginning of the water purge to divert discharge refrigerant gas into the evaporator.

The water pump(s) continues to run, and the water dump valve energizes to purge any remain water in the water trough down the drain.

6. Harvest

The air pump (when used) remains energized and the harvest valve(s) remains open. The refrigerant gas warms the evaporator causing the cubes to slide, as a sheet, off the evaporator and into the storage bin. If the damper/curtain does not open within 3.5 minutes in the harvest cycle the following occurs:

- 3.5 minutes - The water inlet valve energizes until water touches the high water level probe.
- 4 minutes - The water pump energizes.
- 6.5 to 7 minutes - The water dump valve energizes.

When the sliding sheet of cubes opens and closes within 30 seconds the bin switch terminates the harvest sequence and returns the ice machine to the freeze sequence (step 3 - 4).

NOTE: If bin switch does not open before 7 minutes the ice machine will start a Remove Ice Cycle - Refer to "Remove Ice Cycle" on page 71 for details.

Automatic Shut-Off

7. Automatic Shut-Off

When the storage bin is full at the end of a harvest sequence, the sheet of cubes fails to clear the water curtain/ice damper and will hold it open. After the water curtain/ice damper is held open for 30 seconds, the ice machine shuts off. The ice machine remains off for 3 minutes before it can automatically restart.

The ice machine remains off until enough ice has been removed from the storage bin to allow the ice to fall clear of the water curtain or all of the ice dampers. As the water curtain/ice dampers swing back to the closed position, the bin switch re-closes and the ice machine restarts (steps 1 - 2), provided the 3 minute delay period is complete.

ENERGIZED PARTS CHART SELF CONTAINED MODELS

Self Contained Air & Water-Cooled Models

Ice Making Sequence of Operation	Water Pump	Harvest Valve(s)	Air Pump(s)*	Water Inlet Valve	Water Dump Valve	Contacting Coil	Compressor	Condenser Fan Motor	Length of Time
Start-Up									
1. Water Purge	On	Off	Off	Off	On	Off	Off	Off	45 Seconds
2. Pressure Equalization	Off	On	On	Off	Off	Off	Off	Off	5 Seconds
3. Compressor Startup	Off	On	On	Off	Off	On	On	Off	5 Seconds
Freeze Sequence									
4. Prechill	Off	Off	Off	May Cycle On/Off during prechill	Off	On	On	May Cycle On/Off	Initial Start-Up is 120 Seconds 30 Seconds thereafter

Self Contained Air & Water-Cooled Models (Continued)

Ice Making Sequence of Operation	Water Pump	Harvest Valve(s)	Air Pump(s)*	Water Inlet Valve	Water Dump Valve	Contactors Coil	Compressor	Condenser Fan Motor	Length of Time
5. Freeze	On	Off	Off	Cycles Off then On one more time	Off	On	On	May Cycle On/Off	<i>Until Ice Contact w/ Ice Thickness Probe</i>
Harvest Sequence	On	On	On	Off	On	On	On	May Cycle On/Off	<i>Factory Set at 45 Seconds</i>
6. Water Purge	On	On	On	Off	Off	On	On	May Cycle On/Off	<i>Bin Switch Activation</i>
7. Harvest	Off	On	On	Off	Off	On	On	May Cycle On/Off	<i>Until Water Contact w/ Water Level Probe</i>
Water Assist Starts 3.5 minutes in harvest cycle	Off	On	On	On	Off	On	On	May Cycle On/Off	

Self Contained Air & Water-Cooled Models (Continued)

Ice Making Sequence of Operation	Water Pump	Harvest Valve(s)	Air Pump(s)*	Water Inlet Valve	Water Dump Valve	Contactor Coil	Compressor	Condenser Fan Motor	Length of Time
Water Assist Water pump energizes at 4 minutes in harvest cycle	On	On	On	Off	Off	On	On	May Cycle On/Off	Bin Switch Activation or 7 minutes
Water Assist Dump valve energizes at 6.5 minutes in harvest cycle	On	On	On	Off	On	On	On	May Cycle On/Off	**Bin Switch Activation or 7 minutes
8. Automatic Shut-Off	Off	Off	Off	Off	Off	Off	Off	Off	Until 3 Minute Delay Expires and Bin Switch Re-closes

* Not used on all models

** A Remove Ice cycle will start when the bin switch does not open within 7 minutes of the start of a harvest cycle.

REMOTE CONDENSER

NOTE: The power button must be depressed and the water curtain/ice dampers must be in place on the evaporator before the ice machine will start.

Initial Start-Up or Start-Up After Automatic Shut-Off

1. Water Purge

Before the compressor starts, the water pump and water dump solenoid are energized for 45 seconds, to completely purge the ice machine of old water. This feature ensures that the ice making cycle starts with fresh water.

2. Refrigeration System Equalization and Start-Up

The harvest valve, air pump(s) and harvest pressure regulating (HPR) solenoid valves energize to equalize high and low side refrigeration pressure.

After 5 seconds the liquid line solenoid valve energizes and the contactor energizes the compressor and condenser fan motor.

Freeze Sequence

3. Prechill

The compressor is on for 30 seconds (120 seconds initial cycle) to lower the temperature of the evaporator(s) before the water pump is energized. The water fill valve will energize and remain on until water touches the low and high water level probes.

4. Freeze

Water Pump

The water pump(s) energizes and water flows over the evaporator. The water pump is energized throughout the freeze cycle.

Water Inlet Valve

The water inlet valve energized in prechill (30 seconds) and will energize one more time in the freeze cycle. The control board will prevent the water fill valve from energizing after a 6 minute water fill time limit.

After water contacts the low and high water probes the water fill valve de-energizes. Ice builds on the evaporator and the water level drops. When water loses contact with the high water probe, the water fill valve energizes until water contacts the high water probe again.

Ice Thickness Probe

The freeze cycle continues until the six minute freeze lock expires and enough ice has formed to send a signal from the ice thickness probe to the control board.

During the first 6 minutes of the freeze cycle the ice thickness probe microphone samples ambient noise. 6 minutes into the freeze cycle 4 baseline readings are recorded. Ice formation on the evaporator will change the readings; when two of the four baseline readings are exceeded a harvest cycle starts.

Harvest Sequence

5. Water Purge

The air pump (when used) the harvest valve(s) and harvest pressure regulating valve (HPR) energize to divert refrigerant gas to the evaporator.

The water pump continues to run, and the water dump valve energizes to purge the water in the water trough.

6. Harvest

The harvest valve, air pump(s) and harvest pressure regulating (HPR) solenoid valves remain energized and the refrigerant gas warms the evaporator causing the cubes to slide, as a sheet, off the evaporator and into the storage bin. If the damper/curtain does not open within 3.5 minutes in the harvest cycle the following occurs:

- 3.5 minutes - The water inlet valve energizes until water touches the high water level probe.
- 4 minutes - The water pump energizes.
- 6.5 to 7 minutes - The water dump valve energizes.

When the sliding sheet of cubes opens and closes within 30 seconds the bin switch terminates the harvest sequence and returns the ice machine to the freeze sequence (step 3 - 4).

NOTE: If bin switch does not open before 7 minutes the ice machine will start a Remove Ice Cycle - Refer to "Remove Ice Cycle" on page 71 for details.

Automatic Shut-Off

7. Automatic Shut-Off

When the storage bin is full at the end of a harvest sequence, the sheet of cubes fails to clear the water curtain/ice damper and will hold it open. After the water curtain/ice damper is held open for 30 seconds, the ice machine shuts off. The ice machine remains off for 3 minutes before it can automatically restart.

The ice machine remains off until enough ice has been removed from the storage bin to allow the ice to fall clear of the water curtain or all of the ice dampers. As the water curtain/ice dampers swing back to the closed position, the bin switch re-closes and the ice machine restarts (steps 1 - 2), provided the 3 minute delay period is complete.

ENERGIZED PARTS CHART REMOTE MODELS

Remote Air-Cooled Condenser Models Energized Parts Chart

Ice Making Sequence of Operation	Water Pump	Harvest Valve(s)	HPR Valve	Air Pump(s)*	Water Inlet Valve	Water Dump Valve	Contactor Coil Liquid Line Solenoid	Compressor	Condenser Fan Motor	Length of Time
Initial Start-Up										
1. Water Purge	On	Off	Off	Off	Off	On	Off	Off	Off	45 Seconds
2. Pressure Equalization	Off	On	On	On	Off	Off	Off	Off	Off	5 Seconds
3. Compressor Startup	Off	On	Off	On	Off	Off	On	On	On	5 Seconds
Freeze Sequence										
4. Prechill	Off	Off	Off	Off	May Cycle On/ Off during prechill	Off	On	On	On	<i>Initial Start-Up is 120 Seconds 30 Seconds thereafter</i>

Remote Air-Cooled Condenser Models Energized Parts Chart (Continued)

Ice Making Sequence of Operation	Water Pump	Harvest Valve(s)	HPR Valve	Air Pump(s)*	Water Inlet Valve	Water Dump Valve	Contactator Coil Liquid Line Solenoid	Compressor	Condenser Fan Motor	Length of Time
5. Freeze	On	Off	Off	Off	Cycles Off then On one more time	Off	On	On	On	Until Ice Contact w/ Ice Thickness Probe
Harvest Sequence	On	On	On	On	Off	On	On	On	On	Factory Set at 45 Seconds
6. Water Purge	Off	On	On	On	Off	Off	On	On	On	Bin Switch Activation
7. Harvest	Off	On	On	On	On	Off	On	On	On	Until Water Contact w/ Water Level Probe
Water Assist Starts 3.5 minutes in harvest cycle	Off	On	On	On	On	Off	On	On	On	

Remote Air-Cooled Condenser Models Energized Parts Chart (Continued)

Ice Making Sequence of Operation	Water Pump	Harvest Valve(s)	HPR Valve	Air Pump(s)*	Water Inlet Valve	Water Dump Valve	Contactor Coil Liquid Line Solenoid	Compressor	Condenser Fan Motor	Length of Time
Water Assist Water pump energizes at 4 minutes in harvest cycle	On	On	On	On	Off	Off	On	On	On	<i>Bin Switch Activation or 7 minutes</i>
Water Assist Dump valve energizes at 6.5 minutes in harvest cycle	On	On	On	On	Off	On	On	On	On	<i>Bin Switch Activation or 7 minutes</i>
8. Automatic Shut-Off	Off	Off	Off	Off	Off	Off	Off	Off	Off	<i>**Until 3 Minute Delay Expires and Bin Switch Re-closes</i>

* Not used on all models

** A Remove Ice cycle will start when the bin switch does not open within 7 minutes of the start of a harvest cycle.

THIS PAGE INTENTIONALLY LEFT BLANK

Maintenance

Cleaning and Sanitizing

General

You are responsible for maintaining the ice machine in accordance with the instructions in this manual. Maintenance procedures are not covered by the warranty.

Clean and sanitize the ice machine a minimum of once every six months for efficient operation. If the ice machine requires more frequent cleaning and sanitizing, consult a qualified service company to test the water quality and recommend appropriate water treatment. An extremely dirty ice machine must be taken apart for cleaning and sanitizing.

Manitowoc Ice Machine Cleaner and Sanitizer are the only products approved for use in Manitowoc ice machines.

Caution

Use only Manitowoc approved Ice Machine Cleaner and Sanitizer for this application (Manitowoc Cleaner part number 9405463 and Manitowoc Sanitizer part number 9405653). It is a violation of Federal law to use these solutions in a manner inconsistent with their labeling. Read and understand all labels printed on bottles before use.

Caution

Do not mix Cleaner and Sanitizer solutions together. It is a violation of Federal law to use these solutions in a manner inconsistent with their labeling.

Warning

Wear rubber gloves and safety goggles (and/or face shield) when handling Ice Machine Cleaner or Sanitizer.

Cleaning/Sanitizing Procedure

This procedure must be performed a minimum of once every six months.

- The ice machine and bin must be disassembled cleaned and sanitized.
- All ice produced during the cleaning and sanitizing procedures must be discarded.
- Removes mineral deposits from areas or surfaces that are in direct contact with water.

Preventative Maintenance Cleaning Procedure

- This procedure cleans all components in the water flow path, and is used to clean the ice machine between the bi-yearly cleaning/sanitizing procedure.

IAUCS®

iAuCS® does not operate when the Clean button is used to start a clean cycle. To prime the hose, activation is required through the Service Menu/iAuCS® icon.

Exterior Cleaning

Clean the area around the ice machine as often as necessary to maintain cleanliness and efficient operation.

Wipe surfaces with a damp cloth rinsed in water to remove dust and dirt from the outside of the ice machine. If a greasy residue persists, use a damp cloth rinsed in a mild dish soap and water solution. Wipe dry with a clean, soft cloth.

The exterior panels have a clear coating that is stain resistant and easy to clean. Products containing abrasives will damage the coating and scratch the panels.

- Never use steel wool or abrasive pads for cleaning.
- Never use chlorinated, citrus based or abrasive cleaners on exterior panels and plastic trim pieces.

Touchscreen Operation For The Clean Cycle

STARTING A CLEAN CYCLE

Pressing the clean icon will display a Continue/Abort screen, and a warning that pressing Continue will result in a clean cycle that can last up to 35 minutes.

WATER CURTAIN/DAMPER OPERATION DURING THE CLEAN CYCLE

The water curtain/damper must remain closed during the clean sequence. When the curtain/damper is open for more than 3 seconds the clean cycle stops and a message is displayed on the touchscreen with a choice to continue or stop the clean cycle. Stopping the clean cycle will result in a series of rinse and dump cycles to verify cleaner or sanitizer has been removed before ice making.

PAUSING A CLEAN CYCLE

The clean cycle can be paused and resumed at any time by pressing the on/off button. The clean cycle will resume from the beginning of either the wash or rinse cycle depending on the point of interruption.

POWER INTERRUPTION DURING CLEAN CYCLE

If the power supply is interrupted during the clean cycle the state is retained in the circuit board. When power is reapplied the clean cycle will resume from the beginning of either the wash or rinse cycle depending on the point of interruption.

ABORTING A CLEAN CYCLE

Verify cleaner/sanitizer is not present in the water system before aborting a clean cycle.

1. Press and hold the Clean button, then press and release the On/Off button.
2. Release the Clean button and select abort from the touchscreen.

Cleaning/Sanitizing Procedure

Caution

Use only Manitowoc approved Ice Machine Cleaner and Sanitizer for this application (Manitowoc Cleaner part number 9405463 and Manitowoc Sanitizer part number 9405653). It is a violation of Federal law to use these solutions in a manner inconsistent with their labeling. Read and understand all labels printed on bottles before use.

CLEANING PROCEDURE

Caution

Do not mix Cleaner and Sanitizer solutions together. It is a violation of Federal law to use these solutions in a manner inconsistent with their labeling.

Warning

Wear rubber gloves and safety goggles (and/or face shield) when handling Ice Machine Cleaner or Sanitizer.

Ice machine cleaner is used to remove lime scale and mineral deposits. Ice machine sanitizer disinfects and removes algae and slime.

NOTE: Although not required and dependent on your installation, removing the ice machine top cover may allow easier access.

Step 1 Open the front door to access the evaporator compartment. Ice must not be on the evaporator during the clean/sanitize cycle. Follow one of the methods below:

- Press the power switch at the end of a harvest cycle after ice falls from the evaporator(s).
- Press the power switch and allow the ice to melt
- Use the touchpad to initiate a manual harvest cycle.

Notice

Never use anything to force ice from the evaporator. Damage may result.

Step 2 Remove all ice from the bin/dispenser.

Step 3 Press the Clean button and select “Turn off when complete”. Water will flow through the water dump valve and down the drain. Wait approximately 1 minute until the water trough refills and the display indicates Add Chemical. Add the proper amount of ice machine cleaner to the water trough by pouring between the water curtain and evaporator, then confirm the chemical was added.

NOTE: There is a 10 minute time limit to confirm chemical was added.

- Confirmation is pushed within 10 minutes - The ice machine will start a 10 minute wash cycle, followed by 6 rinse and flush cycles.
- Confirmation is not pushed within 10 minutes - The ice machine will skip the 10 minute wash cycle and start 6 rinse and flush cycles.

Model	Amount of Cleaner
IF0300/IT0420/IT0620	3 ounces (90 ml)
IT0450/IT0500/IF0600 IF0900/IT1200	5 ounces (150 ml)
IT1500/IT1900	9 ounces (265 ml)

Step 4 Wait until the clean cycle is complete, then disconnect power to the ice machine (and dispenser when used).

⚠ Warning

Disconnect the electric power to the ice machine at the electric service switch box.

Step 5 Remove parts for cleaning.

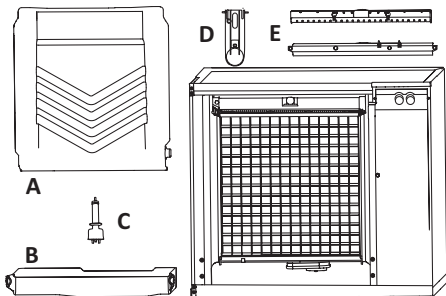

A. Remove the water curtain

- Gently flex the curtain in the center and remove it from the right side.
- Slide the left pin out.

B. Remove the water trough

- Depress tabs on right and left side of the water trough.
- Allow front of water trough to drop as you pull forward to disengage the rear pins.

C. Remove the water level probe

- Pull the water level probe straight down to disengage.
- Lower the water level probe until the wiring connector is visible.
- Disconnect the wire lead from the water level probe.
- Remove the water level probe from the ice machine.

D. Remove the ice thickness probe

- Compress the hinge pin on the top of the ice thickness probe.
- Pivot the ice thickness probe to disengage one pin then the other. The ice thickness probe can be cleaned at this point without complete removal. If complete removal is desired, disconnect the ice thickness control wiring from the control board.

E. Remove the water distribution tube

NOTE: Distribution tube thumbscrews are retained to prevent loss. Loosen thumbscrews but do not pull thumbscrews out of distribution tube.

- Loosen the two outer screws (do not remove screws completely they are retained to prevent loss) and pull forward on the distribution tube to release from slip joint.

Disassemble distribution tube by loosening the two (2) middle thumbscrews and dividing the distribution tube into two pieces. Please refer to the proper parts removal for your ice machine. Continue with step 6 when the parts have been removed.

Step 6 Mix a solution of cleaner and lukewarm water. Depending upon the amount of mineral buildup, a larger quantity of solution may be required. Use the ratio in the table below to mix enough solution to thoroughly clean all parts.

Solution Type	Water	Mixed With
Cleaner	1 gal. (4 L)	16 oz (475 ml) cleaner

Step 7 Use 1/2 of the cleaner/water mixture to clean all components. The cleaner solution will foam when it contacts lime scale and mineral deposits; once the foaming stops use a soft-bristle nylon brush, sponge or cloth (NOT a wire brush) to carefully clean the parts. Soak parts for 5 minutes (15 - 20 minutes for heavily scaled parts). Rinse all components with clean water.

Notice

Do not clean the ice thickness probe in a dishwasher. Permanent damage to the ice thickness probe will occur.

Ice Thickness Probe & Water Level Probe

Clean the probes using the following procedure.

NOTE: Do not soak electrical connectors in cleaner or sanitizer solution.

1. Mix a solution of Manitowoc ice machine cleaner and water (2 ounces of cleaner to 16 ounces of water) in a container.
2. Clean all probe surfaces including all plastic parts (do not use abrasives). Verify all surfaces are clean. Thoroughly rinse probes with clean water.
3. Reinstall probe, then sanitize the ice machine and bin/dispenser interior surfaces.

Step 8 While components are soaking, use 1/2 of the cleaner/water solution to clean all food zone surfaces of the ice machine and bin (or dispenser). Use a nylon brush or cloth to thoroughly clean the following ice machine areas:

- Side walls
- Base (area above water trough)
- Evaporator plastic parts - including top, bottom, and sides
- Bin or dispenser

Rinse all areas thoroughly with clean water.

SANITIZING PROCEDURE

Step 9 Mix a solution of sanitizer and lukewarm water.

Solution Type	Water	Mixed With
Sanitizer	3 gal. (12 L)	2 oz (60 ml) sanitizer

Step 10 Use 1/2 of the sanitizer/water solution to sanitize all removed components. Use a spray bottle to liberally apply the solution to all surfaces of the removed parts or soak the removed parts in the sanitizer/water solution. Do not rinse parts after sanitizing.

Step 11 Use 1/2 of the sanitizer/water solution to sanitize all food zone surfaces of the ice machine and bin (or dispenser). Use a spray bottle to liberally apply the solution. When sanitizing, pay particular attention to the following areas:

- Side walls
- Base (area above water trough)
- Evaporator plastic parts - including top, bottom and sides
- Bin or dispenser

Do not rinse the sanitized areas.

Step 12 Replace all removed components.

Step 13 Wait 20 minutes.

Step 14 Reapply power to the ice machine and press the Clean button.

Step 15 Press the Clean button and select “Make ice when complete”. Water will flow through the water dump valve and down the drain. Wait approximately 1 minute until the water trough refills and the display indicates Add Chemical. Add the proper amount of ice machine sanitizer to the water trough by pouring between the water curtain and evaporator, then confirm the chemical was added.

Model	Amount of Sanitizer
IF0300/IT0420/IT0620	3 ounces (90 ml)
IT0450/IT0500/IF0600 IF0900/IT1200	3 ounces (90 ml)
IT1500/IT1900	6 ounces (180 ml)

Step 16 The ice machine will automatically start ice making after the sanitize cycle is complete.

Water Inlet Valve

The water inlet valve normally does not require removal for cleaning. Refer to “Water System Checklist” page 93, if you are troubleshooting water related problems.

1. When the ice machine is off, the water inlet valve must completely stop water flow into the machine. Watch for water flow.

When the ice machine is on, the water inlet valve must allow the proper water flow through it. Press the Power button to energize the ice machine. Watch for water flow into the ice machine. If the water flow is slow or only trickles into the ice machine, refer to water system checklist.

NOTE: The valve can also be energized by navigating to the service diagnostic menu, selecting control board, then selecting “enable all relays”.

Warning

Disconnect the electric power to the ice machine and dispenser at the electric service switch box and turn off the water supply before proceeding.

Water Dump Valve

The water dump valve normally does not require removal for cleaning. To determine if removal is necessary:

1. Locate the water dump valve.
2. While the ice machine is in the freeze mode, check the drain to determine if the dump valve is leaking. If there is no or little water in the water trough (during the freeze cycle) the dump valve is leaking.
 - A. If the dump valve is leaking, remove, disassemble and clean it.
 - B. If the dump valve is not leaking, do not remove it. Instead, follow the “Ice Machine Cleaning Procedure”.

Preventative Maintenance Cleaning Procedure

This procedure cleans all components in the water flow path, and is used to clean the ice machine between the bi-yearly cleaning/sanitizing procedure.

Ice machine cleaner is used to remove lime scale and mineral deposits. Ice machine sanitizer disinfects and removes algae and slime.

NOTE: Although not required and dependent on your installation, removing the ice machine top cover may allow easier access.

1. Ice must not be on the evaporator during the clean/sanitize cycle. Follow one of the methods below:
 - Press the power switch at the end of a harvest cycle after ice falls from the evaporator(s).
 - Press the power switch and allow the ice to melt.

Notice

Never use anything to force ice from the evaporator. Damage may result.

2. Open the front door to access the evaporator.

3. Press the Clean button and select “Make ice when complete”. Water will flow through the water dump valve and down the drain. Wait approximately 1 minute until the water trough refills and the display indicates Add Chemical. Add the proper amount of ice machine cleaner to the water trough by pouring between the water curtain and evaporator, then confirm the chemical was added.

Model	Amount of Cleaner
IF0300/IT0420/IT0620	3 ounces (90 ml)
IT0450/IT0500/IF0600 IF0900/IT1200	5 ounces (150 ml)
IT1500/IT1900	9 ounces (265 ml)

4. Close and secure the front door. The ice machine will automatically start ice making after the clean cycle is complete (approximately 24 minutes).

NOTE: Once the cycle has started it must complete before the ice machine can make ice again. Returning it to ice making mode will not cancel a clean cycle.

Removal from Service/Winterization

General

Special precautions must be taken if the ice machine is to be removed from service for an extended period of time or exposed to ambient temperatures of 32°F (0°C) or below.

Notice

If water is allowed to remain in the ice machine in freezing temperatures, severe damage to some components could result. Damage of this nature is not covered by the warranty.

Follow the applicable procedure below.

AIR-COOLED ICE MACHINES

1. Press the power button.
2. Turn off the water supply.
3. Remove the water from the water trough.
4. Disconnect and drain the incoming ice-making water line at the rear of the ice machine.
5. Energize the ice machine and wait one minute for the water inlet valve to open - or - Energize all relays in the touchscreen service menu.
6. Blow compressed air in both the incoming water and the drain openings in the rear of the ice machine until no more water comes out of the water inlet lines or the drain.
7. Disconnect the electric power at the circuit breaker or the electric service switch.
8. Make sure water is not trapped in any of the water lines, drain lines, distribution tubes, etc.

WATER-COOLED ICE MACHINES

1. Perform steps 1-6 under "Air-Cooled Ice Machines".
2. Disconnect the incoming water and drain line from the water-cooled condenser.
3. Energize the ice machine in the freeze cycle. The increasing refrigerant pressure will open the water regulating valve.
4. Blow compressed air through the condenser until no water remains.

Troubleshooting

Troubleshooting

LONG FREEZE CYCLE

If the freeze time reaches 35 minutes, the control board automatically initiates a harvest cycle. If 6 consecutive 35-minute freeze cycles occur, the ice machine stops.

LONG HARVEST CYCLE

If the harvest time reaches 7 minutes, the control board will start a remove ice cycle and automatically return the ice machine to the freeze cycle. After 3 consecutive long harvest cycles the ice machine stops.

SAFE OPERATION MODE

Allows the ice machine to operate up to 72 hours if the ice thickness probe (E19 fault) and/or water level probe sensors fail (E20 fault).

- When the control board starts the safe mode an alert is indicated to notify the end-user they have a production problem.
- The control board automatically initiates and monitors the safe mode. The control will automatically exit the safe mode if a normal signal is received from the input.
- After 72 hours the control board will enter a standby mode and turn off.

The control board needs a five cycle history to operate safe mode. If five cycles have never been successfully completed the ice machine will shut-off.

REMOVE ICE CYCLE

When the damper/curtain does not open during the 7 minute harvest cycle the following remove ice cycle occurs:

- 7 minutes - The compressor, harvest solenoid valve and dump valve de-energize.
The water pump remains energized and the water inlet valve energizes until water touches the high water level probe.
- Water is circulated, dumped and refilled to the high water level probe 18 times (approximately 1 hour).
Model 1200 or smaller:
Circulate 165 seconds, dump 45 seconds
Model 1400 and larger:
Circulate 240 seconds, dump 120 seconds
- At the end of the thaw cycle (approximately 1 - 1.75 hour) the ice machine will start another freeze cycle.

Curtain Operation In Water Assist Harvest

- Open & close damper = Continue Thaw Cycle
- Open damper 30 seconds = Full Bin Shutoff

NOTE: Use the keypad and turn the ice machine off and then on to terminate the cycle. Disconnecting and reconnecting power to end the cycle will result in the ice machine restarting in a harvest cycle.

ANALYZING WHY A SERVICE FAULT (E01 & E02) STOPPED THE ICE MACHINE

Service Faults are designed to stop the ice machine prior to major component failures, most often a minor problem or something external to the ice machine. This may be difficult to diagnose, as many external problems occur intermittently.

Example: An ice machine stops intermittently on Service Fault (long freeze times). The problem could be a low ambient temperature at night, a water pressure drop, the water is turned off one night a week, etc.

Refrigeration and electrical component failures will cause a Service Fault trip. Eliminate all electrical components and external causes first. If it appears that the refrigeration system is causing the problem, use Manitowoc's Freeze Cycle Refrigeration System Operational Analysis Table, along with detailed charts, checklists, and other references to determine the cause.

The following checklists are designed to assist the service technician in analysis. However, because there are many possible external problems, do not limit your diagnosis to only the items listed.

E01 LONG FREEZE

Freeze time exceeds 35 minutes for 6 consecutive freeze cycles.

Possible cause checklist

Improper Installation

- Refer to “Installation/Visual Inspection Checklist” on page 92

Water System

- Dirty/defective water level probe
- Low water pressure (20 psig min.)
- High water pressure (80 psig max.)
- High water temperature (90°F/32.2°C max.)
- Clogged water distribution tube
- Dirty/defective water fill valve
- Dirty/defective water dump valve
- Defective water pump
- Loss of water from sump area

Electrical System

- Low incoming voltage
- Ice thickness probe out of adjustment
- Harvest cycle not initiated electrically
- Contactor not energizing
- Compressor electrically non-operational
- Defective fan cycling control
- Defective fan motor

Miscellaneous

- Non-Manitowoc components
- Improper refrigerant charge
- Defective head pressure control
- Defective harvest valve
- Defective compressor
- TXV starving or flooding (check bulb mounting)
- Non-condensable in refrigeration system
- Plugged or restricted high side refrigerant lines or component
- Restricted air flow/dirty condenser fins
- High inlet air temperature
- Condenser discharge air recirculation

E02 LONG HARVEST

Harvest time exceeds 7 minutes for 3 consecutive harvest cycles.

Possible Cause Checklist

Improper Installation

- Refer to “Installation/Visual Inspection Checklist” on page 92

Water System

- Water area (evaporator) dirty
- Dirty/defective water dump valve
- Vent tube not installed on water outlet drain
- Water freezing behind evaporator
- Plastic extrusions and gaskets not securely mounted to the evaporator
- Clogged water distribution tube

Electrical System

- Ice thickness probe out of adjustment
- Bin switch closed/defective
- Premature harvest - The control board initiates a harvest cycle when the high water level probe circuit is complete and the low water level probe is open.

Refrigeration System

- Non-Manitowoc components
- Improper refrigerant charge
- Defective head pressure control valve
- Defective harvest valve
- TXV flooding (check bulb mounting)
- Defective fan cycling control
- Water cooled only - Water regulating valve is incorrectly adjusted or will not close during harvest cycle.

Troubleshooting By Symptom

The troubleshooting procedures follow diagnostic charts. There are four symptoms, the symptom that you are experiencing will determine which diagnostic chart to use. The chart asks yes and no questions to determine the problem. The diagnostic chart will direct you to a procedure to correct the problem. Remote condenser, and self contained models use separate charts.

SYMPTOM #1

Ice Machine Stops Running

Ice machine is in Ice Making cycle

or

Has a History of Shutting Down

- Refer to Ice Machine Stops Running diagnostic chart

SYMPTOM #2

Ice Machine has a Long Freeze Cycle

Ice Formation is Thick

or

Thin Ice Fill on Inlet or Outlet of Evaporator

or

Low Production

Service Fault (possible)

- Refer to Freeze Cycle Refrigeration System Operational Analysis Table

SYMPTOM #3

Ice Machine Will Not Harvest - Freeze Cycle is Normal and Ice Cubes are Not Melted After Harvest

Long Harvest (possible)

- Refer to Refrigeration Harvest Flow Chart

SYMPTOM #4

Ice Machine Will Not Harvest - Freeze Cycle is Normal and Ice Cubes are Melted After Harvest

- Refer to Ice Meltout Flow Chart

RESET TO FACTORY DEFAULTS

Before starting troubleshooting procedures, reset the control board to factory defaults to prevent mis-diagnosis. Before resetting to factory defaults do one of the following:

- A. Copy settings to a USB device and flash settings into the control board when diagnostics are complete.
- B. Write down any customer settings so they can be re-entered when diagnostics are complete.

To reset the ice machine to factory defaults select Menu then Reset Defaults.

SYMPTOM #1 - ICE MACHINE WILL NOT RUN

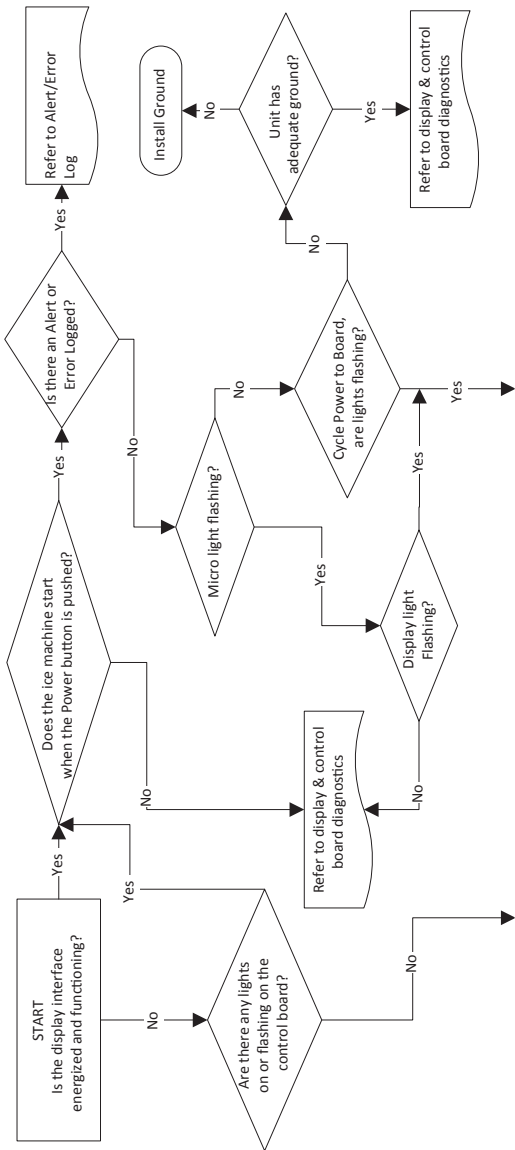

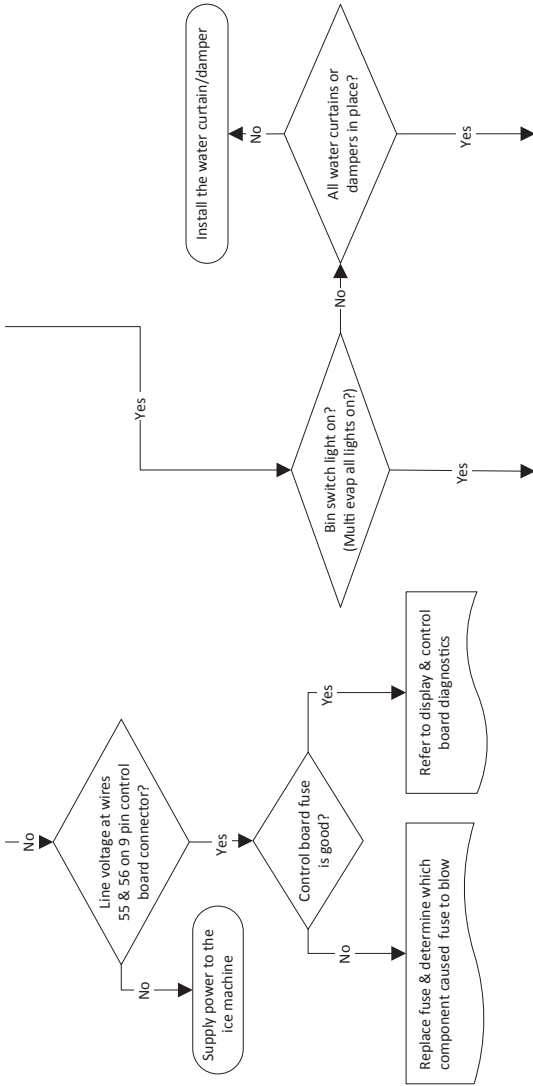

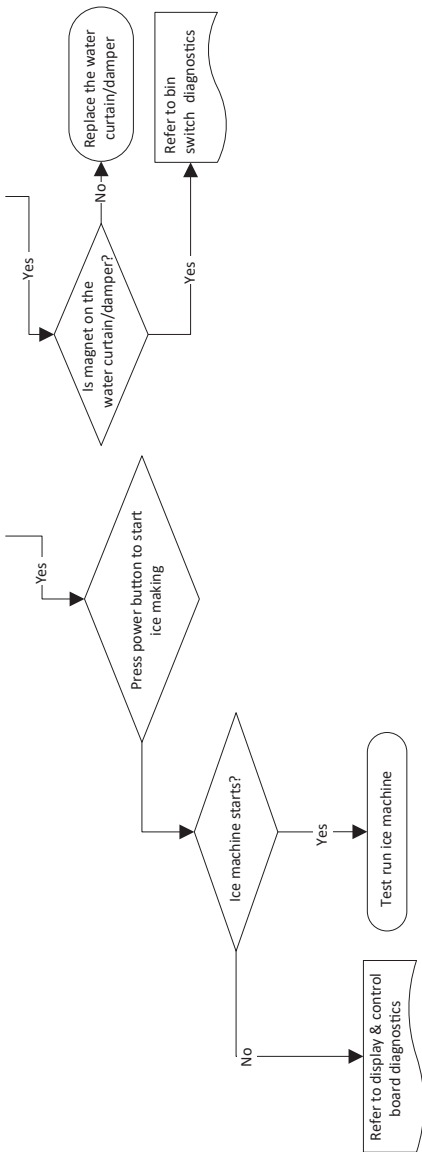

SYMPTOM #2 - LOW PRODUCTION, LONG FREEZE CYCLE

Ice Machine has a Long Freeze Cycle

Ice Formation is Thick

or

Thin on Inlet or Outlet of Evaporator

or

Low Production

How to Use the Freeze Cycle Refrigeration System Operational Analysis Table

GENERAL

These tables must be used with charts, checklists and other references to eliminate refrigeration components not listed on the tables and external items and problems which can cause good refrigeration components to appear defective.

The tables list five different defects that may affect the ice machine's operation.

NOTE: A low-on-charge ice machine and a starving expansion valve have very similar characteristics and are listed under the same column.

NOTE: Before starting, see "Before Beginning Service" for a few questions to ask when talking to the ice machine owner.

PROCEDURE

Step 1 Complete the "Operation Analysis" column.

Read down the left "Operational Analysis" column.

Perform all procedures and check all information listed.

Each item in this column has supporting reference material to help analyze each step.

While analyzing each item separately, you may find an "external problem" causing a good refrigerant component to appear bad. Correct problems as they are found. If the operational problem is found, it is not necessary to complete the remaining procedures.

Step 2 Enter Checkmarks (√).

Each time the actual findings of an item in the “Operational Analysis” column matches the published findings on the table, enter a Checkmark.

Example: Freeze cycle suction pressure is determined to be low. Enter a Checkmark in the “low” column.

Step 3 Add the Checkmarks listed under each of the four columns. Note the column number with the highest total and proceed to “Final Analysis.”

NOTE: If two columns have matching high numbers, a procedure was not performed properly, supporting material was not analyzed correctly or the problem component is not covered by the analysis table.

Before Beginning Service

Ice machines may experience operational problems only during certain times of the day or night. A machine may function properly while it is being serviced, but malfunctions later. Information provided by the user can help the technician start in the right direction, and may be a determining factor in the final diagnosis.

Ask these questions before beginning service:

- When does the ice machine malfunction? (night, day, all the time, only during the Freeze cycle, etc.)
- When do you notice low ice production? (one day a week, every day, on weekends, etc.)
- Can you describe exactly what the ice machine seems to be doing?
- Has anyone been working on the ice machine?
- During “store shutdown,” is the circuit breaker, water supply or air temperature altered?
- Is there any reason why incoming water pressure might rise or drop substantially?

SYMPTOM #2 - FREEZE CYCLE REFRIGERATION SYSTEM OPERATIONAL ANALYSIS TABLES
SINGLE EVAPORATOR, SINGLE EXPANSION VALVE
SELF CONTAINED AIR, WATER & REMOTE CONDENSER

	1	2	3	4
Operational Analysis				
Ice Production Reference "Ice Production Check" on page 90	Air-Temperature Entering Condenser _____ Water Temperature Entering Ice Machine _____ Published 24 hour ice production _____ Calculated (actual) ice production _____ NOTE: The ice machine is operating properly if the ice fill patterns is normal and ice production is within 10% of charted capacity.			
Installation and Water System Reference "Water System Checklist" on page 93	All installation and water related problems must be corrected before proceeding with chart.			
Ice Formation Pattern Reference "Ice Formation Pattern" on page 95	Ice formation is extremely thin on outlet of evaporator -or- No ice formation on the entire evaporator	Ice formation is extremely thin on outlet of evaporator -or- No ice formation on entire evaporator	Ice formation normal -or- Ice formation is extremely thin on inlet of evaporator -or- No ice formation on entire evaporator	Ice formation normal -or- No ice formation on entire evaporator

**SINGLE EVAPORATOR, SINGLE EXPANSION VALVE
SELF CONTAINED AIR, WATER & REMOTE CONDENSER**

	1	2	3	4
Operational Analysis Freeze Cycle Discharge Pressure _____ Middle _____ _____ End _____ 1 minute into cycle	If discharge pressure is High or Low refer to freeze cycle high or low discharge pressure problem checklist page 100 to eliminate problems and/or components not listed on this table before proceeding.			
Freeze Cycle Suction Pressure _____ Middle _____ _____ End _____ 1 minute into cycle	If suction pressure is High or Low refer to freeze cycle high or low suction pressure problem checklist page 103 to eliminate problems and/or components not listed on this table before proceeding.			
	Suction pressure is High	Suction pressure is Low or Normal	Suction pressure is High	Suction pressure is High

**SINGLE EVAPORATOR, SINGLE EXPANSION VALVE
SELF CONTAINED AIR, WATER & REMOTE CONDENSER**

Operational Analysis	1	2	3	4
<p>Wait 5 minutes into the freeze cycle.</p> <p>Compare temperatures of evaporator inlet and evaporator outlet.</p> <p>Inlet T3 _____ ° F (°C)</p> <p>Outlet T4 _____ ° F (°C)</p> <p>Difference</p> <p>T3 & T4 _____ ° F (°C)</p> <p>Reference "Comparing Evaporator Inlet and Outlet Temperatures - Self-contained & Remote Condenser Single Expansion Valve Machines" on page 105</p>	<p>Inlet and outlet within 7° F (4°C) of each other</p>	<p>Inlet and outlet not within 7° F (4°C) of each other -and- Inlet is colder than outlet</p>	<p>Inlet and outlet within 7° F (4°C) of each other -or- Inlet and outlet not within 7° F (4°C) of each other -and- Inlet is warmer than outlet</p>	<p>Inlet and outlet within 7° F (4°C) of each other</p>

**SINGLE EVAPORATOR, SINGLE EXPANSION VALVE
SELF CONTAINED AIR, WATER & REMOTE CONDENSER**

	1	2	3	4
<p>Operational Analysis</p> <p>Wait 5 minutes into the freeze cycle.</p> <p>Compare temperatures of compressor discharge line and harvest valve inlet.</p> <p>Reference "Harvest Valve Analysis" on page 106</p> <p>Discharge Line Temperature</p> <p>Record freeze cycle discharge line temperature at the end of the freeze cycle.</p> <p>T2 _____ °F (°C)</p> <p>Reference "Discharge Line Temperature Analysis" on page 108</p>	<p>The harvest valve inlet is Hot -and- approaches the temperature of a Hot compressor discharge line.</p>	<p>The harvest valve inlet is Cool enough to hold hand on -and- the compressor discharge line is Hot.</p>	<p>The harvest valve inlet is Cool enough to hold hand on -and- the compressor discharge line is Cool enough to hold hand on.</p>	<p>The harvest valve inlet is Cool enough to hold hand on -and- the compressor discharge line is Hot.</p>
	<p>Discharge line temp. 150°F (65°C) or higher at the end of the freeze cycle</p>	<p>Discharge line temp. 150°F (65°C) or higher at the end of the freeze cycle</p>	<p>Discharge line temp. less than 150°F (65°C) at the end of the freeze cycle</p>	<p>Discharge line temp. 150°F (65°C) or higher at the end of the freeze cycle</p>

**SINGLE EVAPORATOR, SINGLE EXPANSION VALVE
SELF CONTAINED AIR, WATER & REMOTE CONDENSER**

	1	2	3	4
Operational Analysis Enter total number of boxes checked in each column. Reference "Final Analysis - Self-contained Air, Water & Remote Condenser Models" on page 110	Harvest Valve Leaking	Low On Charge -or- TXV Starving	TXV Flooding	Compressor

The following are the procedures for completing each step of the Freeze Cycle Refrigeration System Operational Analysis Tables. Each procedure must be performed exactly for the table to work correctly.

**SINGLE EVAPORATOR, DUAL EXPANSION VALVE
SELF CONTAINED AIR, WATER & REMOTE CONDENSER**

	1	2	3	4
Operational Analysis				
Ice Production	Air-Temperature Entering Condenser _____ Water Temperature Entering Ice Machine _____ Published 24 hour ice production _____ Calculated (actual) ice production _____ NOTE: The ice machine is operating properly if the ice fill patterns is normal and ice production is within 10% of charted capacity.			
Installation and Water System	All installation and water related problems must be corrected before proceeding with table.			
Ice Formation Pattern				
Top or 1 Side _____	Ice formation is extremely thin on outlet of evaporator	Ice formation is extremely thin on outlet of one side or Top or Bottom of evaporator	Ice formation normal -or- Ice formation is extremely thin at inlet of one side or Top or Bottom of evaporator	Ice formation normal -or- No ice formation on entire evaporator
Bottom or 1 Side _____	No ice formation on one side or Top or Bottom of evaporator	No ice formation on entire evaporator	No ice formation on entire evaporator	No ice formation on entire evaporator

**SINGLE EVAPORATOR, DUAL EXPANSION VALVE
SELF CONTAINED AIR, WATER & REMOTE CONDENSER**

Operational Analysis	1	2	3	4
Freeze Cycle Discharge Pressure <hr/> 1 minute Middle End into cycle	If discharge pressure is High or Low refer to freeze cycle high or low discharge pressure problem checklist page 100 to eliminate problems and/or components not listed on this table before proceeding.			
Freeze Cycle Suction Pressure <hr/> 1 minute Middle End into cycle Wait 5 minutes into the freeze cycle. Compare temperatures of compressor discharge line and both harvest valve inlets.	If suction pressure is High or Low refer to freeze cycle high or low suction pressure problem checklist page 103 to eliminate problems and/or components not listed on this table before proceeding.			
	Suction pressure is High	Suction pressure is Low or Normal	Suction pressure is High	Suction pressure is High
	The harvest valve inlet is Hot -and- approaches the temperature of a Hot compressor discharge line.	The harvest valve inlet is Cool enough to hold hand on -and- the compressor discharge line is Hot .	The harvest valve inlet is Cool enough to hold hand on -and- the compressor discharge line is Cool enough to hold hand on.	The harvest valve inlet is Cool enough to hold hand on -and- the compressor discharge line is Hot .

**SINGLE EVAPORATOR, DUAL EXPANSION VALVE
SELF CONTAINED AIR, WATER & REMOTE CONDENSER**

	1	2	3	4
Operational Analysis Discharge Line Temperature Record freeze cycle discharge line temperature at the end of the freeze cycle _____ °F (°C)	Discharge line temp. 150°F (65°C) or higher at the end of the freeze cycle	Discharge line temp. 150°F (65°C) or higher at the end of the freeze cycle	Discharge line temp. less than 150°F (65°C) at the end of the freeze cycle	Discharge line temp. 150°F (65°C) or higher at the end of the freeze cycle
Final Analysis Enter total number of boxes checked in each column	Harvest Valve Leaking	Low On Charge -or- TXV Starving	TXV Flooding	Compressor

Ice Production Check

The amount of ice a machine produces directly relates to the operating water and air temperatures. This means a condensing unit with a 70°F (21°C) outdoor ambient temperature and 50°F (10°C) water produces more ice than the same model condensing unit with a 90°F (32°C) outdoor ambient temperature and 70°F (21°C) water.

1. Determine the ice machine operating conditions:
Air temp entering condenser: ____°
Water temp entering sump trough: ____°
2. Refer to the appropriate 24-Hour Ice Production Chart (starting on page 195). Use the operating conditions determined in step 1 to find published 24-Hour Ice Production: _____
 - Times are in minutes.
Example: 1 min. 15 sec. converts to 1.25 min.
(15 seconds ÷ 60 seconds = .25 minutes)
 - Weights are in pounds.
Example: 2 lb. 6 oz. converts to 2.375 lb.
(6 oz. ÷ 16 oz. = .375 lb.)
3. Perform an ice production check using the formula below.

1.	$\frac{\text{Freeze Time}}{\text{Freeze Time}}$	+	$\frac{\text{Harvest Time}}{\text{Harvest Time}}$	=	$\frac{\text{Total Cycle Time}}{\text{Total Cycle Time}}$
2.	$\frac{1440}{\text{Minutes in 24 Hrs.}}$	÷	$\frac{\text{Total Cycle Time}}{\text{Total Cycle Time}}$	=	$\frac{\text{Cycles per Day}}{\text{Cycles per Day}}$
3.	$\frac{\text{Weight of One Harvest}}{\text{Weight of One Harvest}}$	x	$\frac{\text{Cycles per Day}}{\text{Cycles per Day}}$	=	$\frac{\text{Actual 24-Hour Production}}{\text{Actual 24-Hour Production}}$

Weighing the ice is the only 100% accurate check.

However, if the ice pattern is normal and the 1/8" (3 mm) thickness is maintained, the ice slab weights listed with the 24-Hour Ice Production Charts may be used.

4. Compare the results of step 3 with step 2. Ice production checks that are within 10% of the chart are considered normal. If they match closely, determine if:
 - Another ice machine is required.
 - More storage capacity is required.
 - Relocating the existing equipment to lower the load conditions is required.

Contact the local Manitowoc Distributor for information on available options and accessories.

Installation/Visual Inspection Checklist

Inadequate Clearances

- Check all clearances on sides, back and top. Reference “Clearance Requirements” on page 24

Ice machine is not level

- Level the ice machine

Condenser is dirty

- Clean the condenser

Water filtration is plugged (if used)

- Install a new water filter

Water drains are not run separately and/or are not vented

- Run and vent drains according to the Installation Manual
- Floor drain must have an air gap
- Install condensation drain in the ice machine base

Line set is improperly installed

- Reinstall according to the “Water Supply and Drains” on page 27

Water System Checklist

A water-related problem often causes the same symptoms as a refrigeration system component malfunction.

Water system problems must be identified and eliminated prior to replacing refrigeration components.

Water area (evaporator) is dirty

- Clean as needed

Water inlet pressure not between 20 and 80 psig (1-5 Bar, 138-552 kPa)

- Install water regulator or increase water pressure

Incoming water temperature is not between 35°F (2°C) and 90°F (32°C)

- If too hot, check the hot water line check valves in other store equipment

Water filtration is plugged (if used)

- Install a new water filter

Water dump valve leaking during the Freeze cycle

- Clean/replace dump valve as needed

Vent tube is not installed on water outlet drain

- See Installation Instructions

Hoses, fittings, etc., are leaking water

- Repair/replace as needed

Water fill valve is stuck open or closed

- Clean/replace as needed

Water is leaking out of the sump trough area

- Stop the water loss

Uneven water flow across the evaporator

- Clean the ice machine

Plastic extrusions and gaskets are not secured to the evaporator

- Remount/replace as needed

Condensation drain line is not installed

- Install condensation drain in the ice machine base

Ice Formation Pattern

Evaporator ice formation pattern analysis is helpful in ice machine diagnostics.

Analyzing the ice formation pattern alone cannot diagnose an ice machine malfunction. However, when this analysis is used along with Manitowoc's Freeze Cycle Refrigeration System Operational Analysis Tables, it can help diagnose an ice machine malfunction.

Any number of problems can cause improper ice formation.

Important

Keep the water curtain/ice dampers in place while checking the ice formation pattern to ensure no water is lost.

1. Normal Ice Formation

Ice forms across the entire evaporator surface.

At the beginning of the Freeze cycle, it may appear that more ice is forming on the inlet of the evaporator than on the outlet. At the end of the Freeze cycle, ice formation at the outlet will be close to, or just a bit thinner than, ice formation at the inlet. The dimples in the cubes at the outlet of the evaporator may be more pronounced than those on the inlet. This is normal.

It is normal for ice thickness to vary up to 1/16" across the surface of the evaporator. The ice bridge thickness at the ice thickness control probe should be at least 1/8".

The ice thickness probe must be set to maintain the ice bridge thickness at approximately 1/8". If ice forms uniformly across the evaporator surface, but does not reach 1/8" in the proper amount of time, this is still considered a normal ice fill pattern.

2. Extremely Thin at Evaporator Outlet

There is no ice, or a considerable lack of ice formation, at the outlet of the evaporator.

Examples: No ice at all on the outlet half of the evaporator, but ice forms on the inlet half of the evaporator. Or, the ice at the outlet of the evaporator reaches 1/8" to initiate a harvest, but the inlet of the evaporator already has 1/2" to 1" of ice formation.

3. Extremely Thin at Evaporator Inlet

There is no ice, or a considerable lack of ice formation at the inlet of the evaporator. Examples: The ice at the outlet of the evaporator reaches 1/8" to initiate a harvest, but there is no ice formation at all on the inlet of the evaporator.

4. No Ice Formation

The ice machine operates for an extended period, but there is no ice formation at all on the evaporator.

Evaporator Tubing Routing

Routing of the tubing on the back of the evaporator determines the ice fill pattern failure mode.

One Evaporator, One TXV models

The evaporator outlet tubing does not exit directly at the top of the evaporator, but exits several inches below the top of the evaporator. Extremely Thin at the Evaporator Outlet will first be visible several inches below the top of the evaporator. Extremely Thin at Evaporator Inlet will first be visible at the bottom of the evaporator.

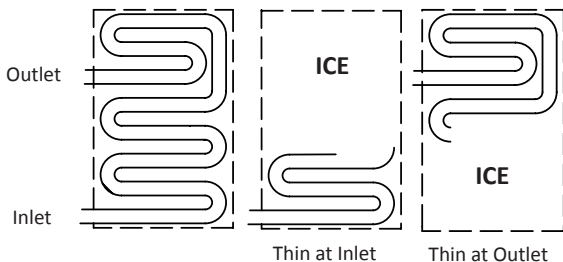

One Evaporator, Two TXV 30" Models

Tubing routing for one evaporator with two TXV's is different. The evaporator has two inlets and outlets. Fill pattern varies depending on which circuit is affected,

Extremely Thin at the Evaporator Outlet will first be visible either 1/4 or 3/4 of the way down the evaporator.

Extremely Thin at the Evaporator Inlet will show at the bottom of the evaporator or 1/2 of the way down depending on the circuit affected.

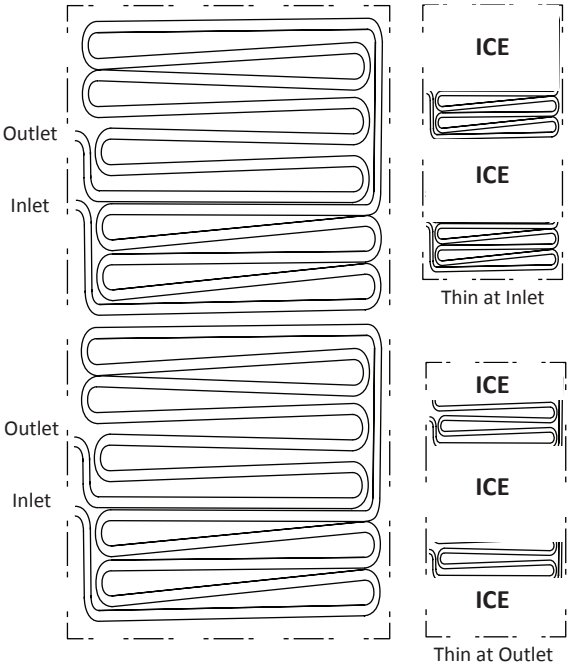

One Evaporator, Two TXV 48" Models

Tubing routing for one evaporator with two TXV's is different. The evaporator has two inlets and outlets. Fill pattern varies depending on which circuit is affected.

Extremely Thin at the Evaporator Outlet will first be visible 1/3 of the way down the evaporator. Only one side of the evaporator may be affected depending on failure. A TXV failure will usually show on only one side, while low on refrigerant can affect one or both sides depending on the amount of refrigerant loss and ambient temperature.

Extremely Thin at the Evaporator Inlet will show at the bottom of the evaporator. Depending on the failure either the entire bottom of the evaporator or one side of the bottom of the evaporator may be affected.

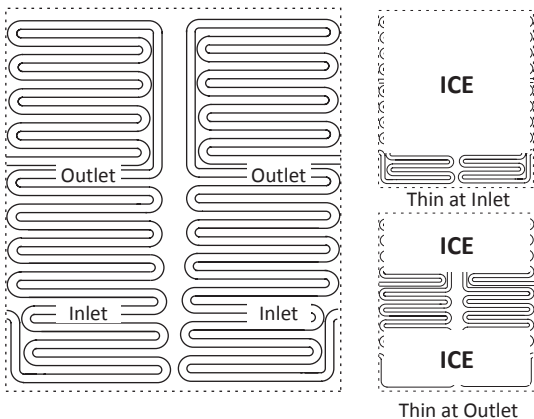

Analyzing Discharge Pressure in the Freeze Cycle

1. Determine the ice machine operating conditions:
Air temp. entering condenser _____ °
Water temp. entering sump trough _____ °
2. Refer to Operating Pressure table (starting on page 195) for ice machine being checked.

Use the operating conditions determined in step 1 to find the published normal discharge pressures:

Freeze Cycle _____

Harvest Cycle _____

3. Perform an actual discharge pressure check.

Freeze Cycle
psig (kPa)

1 Minute into the

Freeze Cycle _____

Middle of Freeze Cycle _____

End of Freeze Cycle _____

4. Compare the actual discharge pressure (step 3) with the published discharge pressure (step 2).

The discharge pressure is normal when the actual pressure falls within the published pressure range for the ice machine's operating conditions. It is normal for the discharge pressure to be higher at the beginning of the Freeze cycle (when load is greatest), then drop throughout the Freeze cycle.

Freeze Cycle Discharge Pressure High Checklist

Improper Installation

- Refer to “Installation/Visual Inspection Checklist” on page 92

Air Condenser

- Dirty condenser filter
- Dirty condenser fins
- High inlet air temperature
- Condenser discharge air recirculation
- Defective fan cycling control
- Defective fan motor
- Defective head pressure control valve (Remote)

Water Condenser

- Low water pressure (20 psig [138 kPa] min.)
- High inlet water temperature (90°F/32°C max.)
- Dirty condenser
- Dirty/Defective water regulating valve
- Water regulating valve out of adjustment

Other

- Overcharged
- Non-condensable (air) in system
- Wrong type of refrigerant
- Non-Manitowoc components in system
- High side refrigerant lines/component restricted

Freeze Cycle Discharge Pressure Low Checklist

Improper Installation

- Refer to “Installation/Visual Inspection Checklist” on page 92

Air Cooled Condensers

- Defective head pressure control valve, won't bypass “Fan Cycle Control” on page 156
- Defective fan cycle control, stuck closed “Fan Cycle Control” on page 156

Water Cooled Condensers

- Water Regulating Valve out of adjustment
- Water Regulating Valve Defective

Other

- Undercharged
- Wrong type of refrigerant
- Non-Manitowoc components in system
- Liquid line/component restricted

Analyzing Suction Pressure

The suction pressure gradually drops throughout the freeze cycle. The actual suction pressure (and drop rate) changes as the air and water temperature entering the ice machine changes. These variables also determine the freeze cycle times.

To analyze and identify the proper suction pressure drop throughout the freeze cycle, compare the published suction pressure to the published freeze cycle time.

NOTE: Analyze discharge pressure before analyzing suction pressure. High or low discharge pressure may be causing high or low suction pressure.

1. Determine the ice machine operating conditions:
Air temp. entering condenser _____°
Water temp. entering sump trough _____°
2. Refer to Operating Pressure table (starting on page 195) for ice machine being checked.

Use the operating conditions determined in step 1 to find the published normal discharge pressures:

Freeze Cycle _____
Harvest Cycle _____

3. Perform an actual suction pressure check.

Freeze Cycle psig (kPa)

1 Minute into the

Freeze Cycle _____

Middle of Freeze Cycle _____

End of Freeze Cycle _____

4. Compare the actual suction pressure (step 3) with the published suction pressure (step 2).

NOTE: The suction pressure is normal when the actual pressure falls within the published pressure range for the ice machine's operating conditions. It is normal for the suction pressure to be higher at the beginning of the Freeze cycle (when load is greatest), then drop throughout the Freeze cycle.

Suction Pressure High Checklist

Improper Installation

- Refer to “Installation/Visual Inspection Checklist” on page 92

Discharge Pressure

- Discharge pressure is too high and is affecting suction pressure – refer to “Freeze Cycle Discharge Pressure High Checklist” on page 100

Improper Refrigerant Charge

- Overcharged (also see “Freeze Cycle Discharge Pressure High Checklist” on page 100)
- Wrong type of refrigerant
- Non condensible in system

Components

- Harvest valve leaking
- Harvest pressure solenoid valve leaking
- TXV flooding
- Defective compressor

Other

- Non-Manitowoc components in system

Suction Pressure Low Checklist

Improper Installation

- Refer to “Installation/Visual Inspection Checklist” on page 92

Discharge Pressure

- Discharge pressure is too low and is affecting low side – refer to “Freeze Cycle Discharge Pressure Low Checklist” on page 101

Improper Refrigerant Charge

- Undercharged
- Wrong type of refrigerant

Other

- Non-Manitowoc components in system
- Improper water supply over evaporator – refer to “Water System Checklist” on page 93
- Restricted/plugged liquid line drier
- Restricted/plugged tubing in suction side or liquid line of refrigeration system
- TXV starving

Comparing Evaporator Inlet and Outlet Temperatures - Self-contained & Remote Condenser Single Expansion Valve Machines

The temperatures of the suction lines entering and leaving the evaporator alone cannot diagnose an ice machine. However, comparing these temperatures during the freeze cycle, along with using Manitowoc's Freeze Cycle Refrigeration System Operational Analysis Table, can help diagnose an ice machine malfunction.

The actual temperatures entering and leaving the evaporator vary by model, and change throughout the freeze cycle. This makes documenting the "normal" inlet and outlet temperature readings difficult. The key to the diagnosis lies in the difference between the two temperatures five minutes into the freeze cycle. These temperatures should be within 7° of each other.

Use this procedure to document freeze cycle inlet and outlet temperatures.

1. Navigate to Service/Diagnostics/Temperature Sensors.
2. Wait 5 minutes into the freeze cycle.
3. Record the evaporator inlet (T3) and outlet (T4) temperatures at 5 minutes into the freeze cycle. Determine the difference.
4. Record the information on the table.

Harvest Valve Analysis

Symptoms of a harvest valve remaining partially open during the freeze cycle can be similar to symptoms of either an expansion valve or compressor problem. The best way to diagnose a harvest valve is by using Manitowoc's Ice Machine Freeze Cycle Refrigeration System Operational Analysis Table.

Use the following procedures to determine if a harvest valve is remaining partially open during the freeze cycle.

SELF-CONTAINED OR REMOTE CONDENSER MODELS HARVEST VALVE ANALYSIS

1. Wait five minutes into the freeze cycle.
2. Feel the inlet of the harvest valve(s).

Important

Feeling the harvest valve outlet or across the harvest valve itself will not work for this comparison.

The harvest valve outlet is on the suction side (cool refrigerant). It may be cool enough to touch even if the valve is leaking.

3. Feel the compressor discharge line.
4. Compare the temperature of the inlet of the harvest valves to the temperature of the compressor discharge line.

Caution

The inlet of the harvest valve and the compressor discharge line could be hot enough to burn your hand. Just touch them momentarily.

Findings	Comments
<p>The inlet of the harvest valve is cool enough to touch and the compressor discharge line is hot.</p> <p style="text-align: center;">Cool & Hot</p>	<p style="text-align: center;">Normal Operation</p> <p>This is normal as the discharge line should always be too hot to touch and the harvest valve inlet, although too hot to touch during harvest, should be cool enough to touch after 5 minutes into the freeze cycle.</p>
<p>The inlet of the harvest valve is hot and approaches the temperature of a hot compressor discharge line.</p> <p style="text-align: center;">Hot & Hot</p>	<p style="text-align: center;">Leaking Harvest Valve</p> <p>The harvest valve inlet did not cool down during the freeze cycle due to continual leakage of compressor discharge gas through the valve.</p>
<p>Both the inlet of the harvest valve and the compressor discharge line are cool enough to touch.</p> <p style="text-align: center;">Cool & Cool</p>	<p style="text-align: center;">Harvest Valve Not Leaking</p> <p>The compressor discharge line should not be cool to the touch 5 minutes into the freeze cycle. This symptom would not be caused by a harvest valve leaking.</p>

5. Record your findings on the table.

Discharge Line Temperature Analysis

GENERAL

Knowing if the discharge line temperature is increasing, decreasing or remaining constant can be an important diagnostic tool. Compressor discharge line temperature on a normally operating ice machine steadily increases throughout the freeze cycle.

Ambient air temperatures affect the discharge line temperature.

Higher ambient air temperatures at the condenser and/or higher inlet water temperature = higher discharge line temperatures at the compressor.

Lower ambient air temperatures at the condenser and/or lower supply water temperature = lower discharge line temperatures at the compressor.

Regardless of ambient and water temperatures, the freeze cycle discharge line temperature should be higher than 150°F (66°C) at the end of the freeze cycle.

PROCEDURE

1. Navigate to Service/Diagnostics/Temperature Sensors/T2 Thermistor.
2. Observe the discharge line temperature (T2) for the last three minutes of the freeze cycle and record on the table.

Water Regulating Valve

Problem (Freeze Cycle)

Valve not maintaining discharge pressure.

- Valve incorrectly set, dirty or defective. Adjust valve to correct discharge pressure for your model (refer to cycle times/24 hour productions charts), clean or replace valve.

Discharge pressure extremely high; Liquid line entering receiver feels hot

- Water regulating valve incorrectly set or not opening
- Insufficient water volume - undersized/kinked lines, mineral or scale buildup in lines.

Discharge pressure low, Liquid line entering receiver feels warm to hot

- Ice machine low on charge. Verify “USB Flash Drive Specifications:” on page 133.

Water pressure forces water regulating valve open

- Reduce incoming water pressure or install high pressure water regulating valve.

Final Analysis - Self-contained Air, Water & Remote Condenser Models

The column with the highest number of check marks identifies the refrigeration problem.

COLUMN 1 - HARVEST VALVE LEAKING

Replace the valve as required.

COLUMN 2 - LOW CHARGE/TXV STARVING

Normally, a starving expansion valve only affects the freeze cycle pressures, not the harvest cycle pressures. A low refrigerant charge normally affects both pressures. Verify the ice machine is not low on charge before replacing an expansion valve.

1. Add refrigerant charge to verify a low charge (air and water self-contained only). Do not add more than 30% of nameplate refrigerant charge. If the problem is corrected, the ice machine is low on charge.

NOTE: Do not add charge to remote models. The symptoms of a remote low on charge will result in a safety long freeze in cool ambient temperatures. Check the liquid line temperature at the ice machine. The liquid line will be hot with a normal or below normal head pressure in freeze when the ice machine is low on refrigerant.

2. Find the refrigerant leak. The ice machine must operate with the nameplate charge. If the leak cannot be found, proper refrigerant procedures must still be followed. Change the liquid line drier. Then, evacuate and weigh in the proper charge.
3. If the problem is not corrected by adding charge, the expansion valve is faulty.

COLUMN 3 - TXV FLOODING OR REFRIGERANT OVERCHARGE

A loose or improperly mounted expansion valve bulb causes the expansion valve to flood. Check bulb mounting, insulation, etc, before changing the valve. Verify refrigerant amount is correct by weighing recovered refrigerant before replacing a TXV.

COLUMN 4 - COMPRESSOR

Replace the compressor. To receive warranty credit, the compressor ports must be properly sealed by crimping and soldering them closed.

SYMPTOM #3 & #4 - HARVEST PROBLEMS SELF-CONTAINED AIR, WATER & REMOTE CONDENSER MODELS

Definition of a harvest problem; At the end of a 3.5 minute harvest cycle the slab of ice is still contacting the evaporator. The slab of ice may or may not be removable by hand.

Harvest problems can be split into two symptoms.

- Symptom 3 - Normal sheet of cubes at the end of the harvest cycle. Ice is difficult to remove from the evaporator by hand. Once removed the back of the cubes are square and show no signs of melting. This indicates a refrigeration problem. The source of the problem could be in the freeze or harvest cycle. Use the appropriate flow chart (in Troubleshooting) to determine the cause of the problem.
- Symptom 4 - Melted sheet of cubes at the end of the harvest cycle. Ice can be removed rather easily by hand. The back of the cubes are misshapen and melted. This indicates something is preventing the ice slab from releasing. Follow the appropriate flow chart (in Troubleshooting) to determine the cause of the problem. A manual cleaning procedure must always be performed when this problem is encountered.

SYMPTOM #3 - SELF-CONTAINED AIR OR WATER-COOLED

Ice Machine Will Not Harvest - Normal Ice Fill and Ice Cubes are Not Melted After Harvest

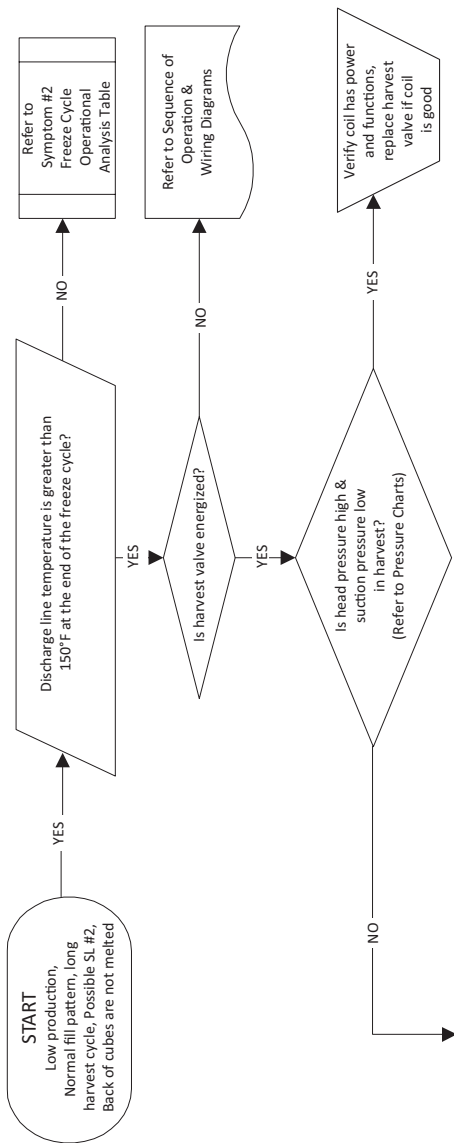

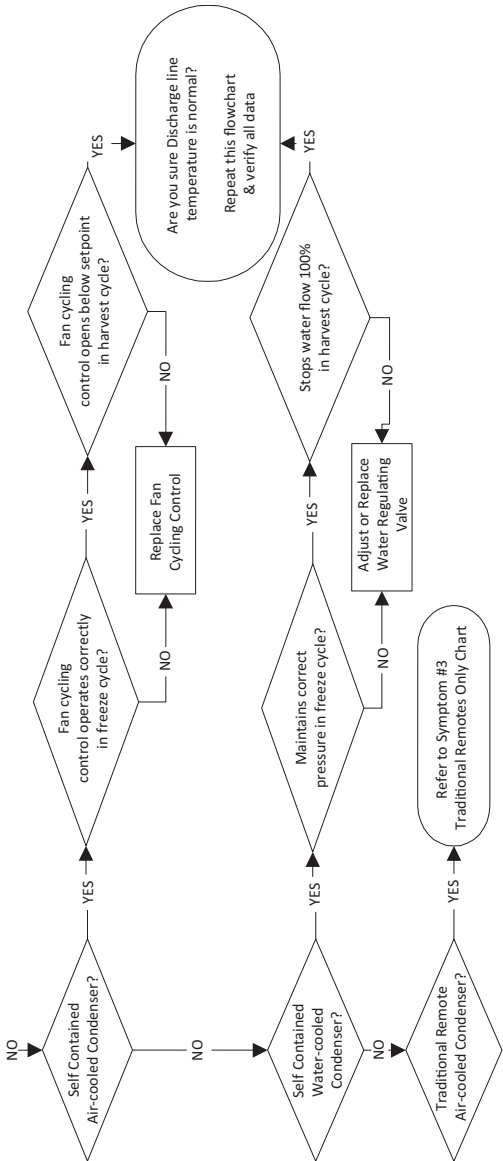

SYMPTOM #3 - REMOTE CONDENSER

Traditional Remote Ice Machine - Long Harvest/Low Production/Intermittent Service Fault E02

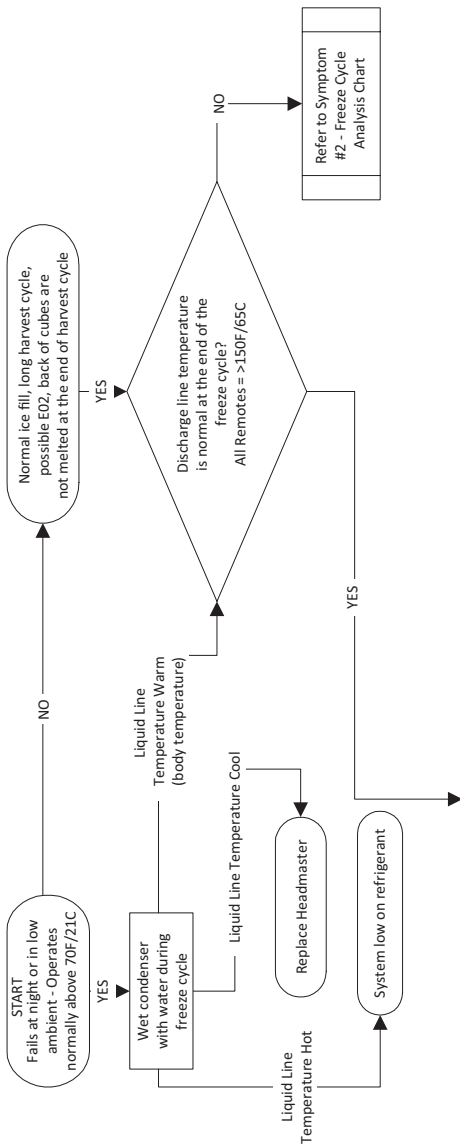

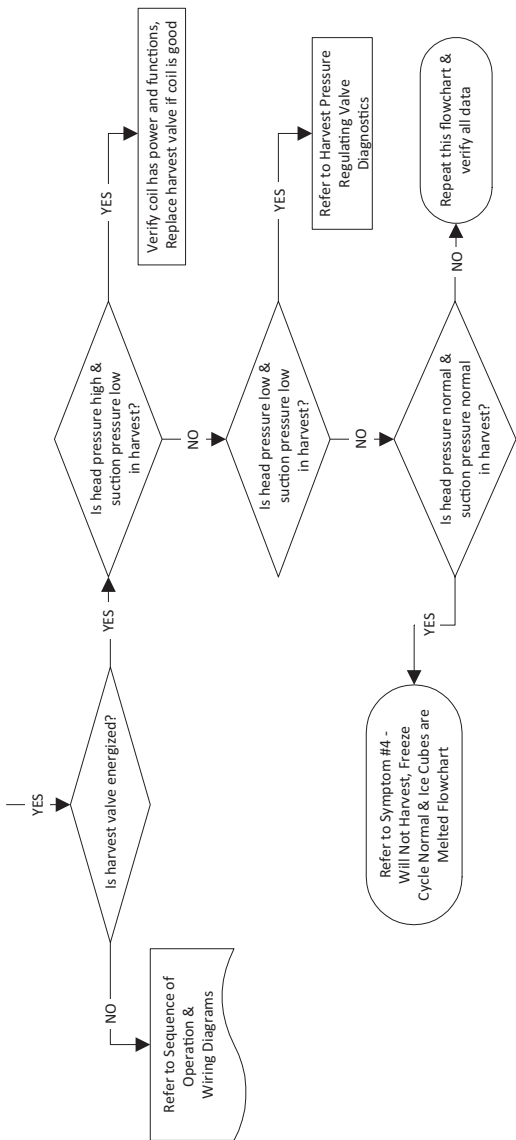

Single Evaporator Systems with Dual Harvest Valves: If one Harvest Valve is open and the other is restricted / stuck closed you may have normal harvest pressures. Look for ice not melting on one side of the evaporator.

SYMPTOM #4 - SELF-CONTAINED AIR, WATER-COOLED OR REMOTE

Ice Machine Will Not Harvest - Freeze Cycle is Normal and Ice Cubes are Melted After Harvest

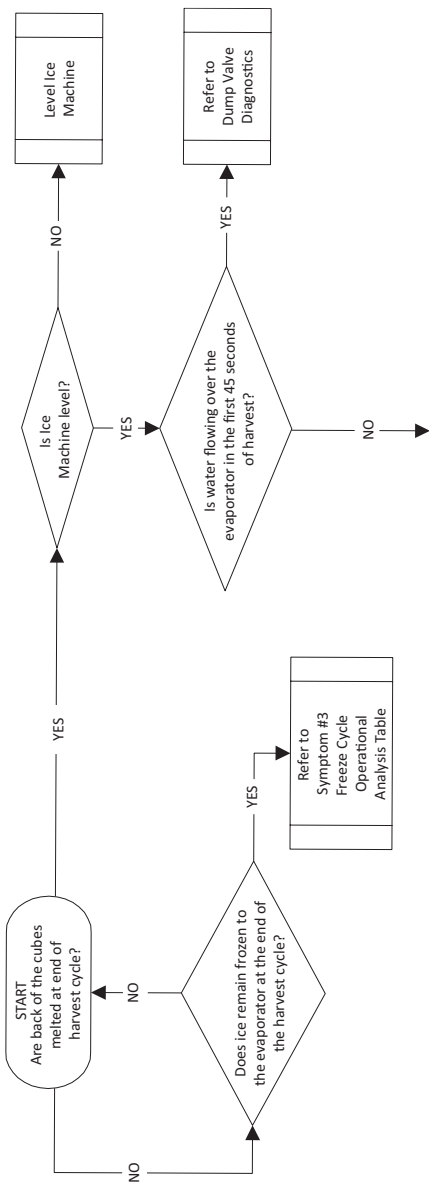

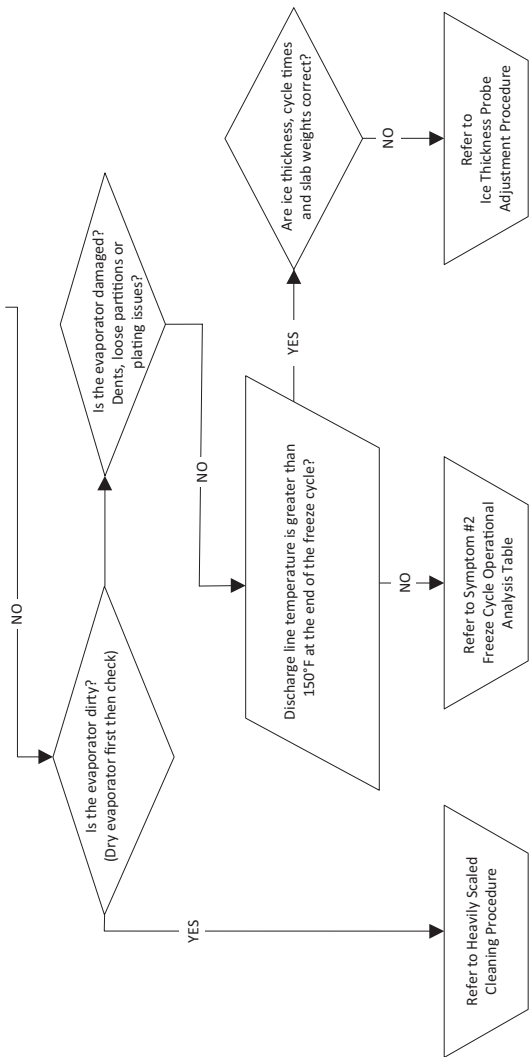

THIS PAGE INTENTIONALLY LEFT BLANK

Controls



Touch Screen Features

The Indigo® control panel offers a series of pressure-sensitive buttons and an interactive touchscreen.

Buttons

Power Button: Provides On/Off functions for the ice machine.

Lock/Unlock Button: Allows or prevents touchscreen navigation.

Cleaning Button: Initiates a cleaning cycle. Refer to “Cleaning and Sanitizing” on page 53 for details.

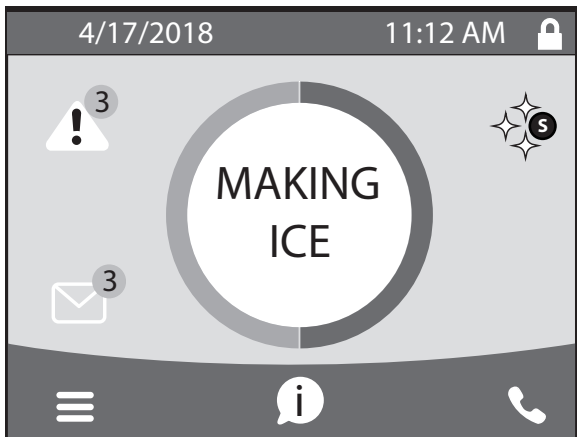









Touchscreen

Home screen allows viewing of ice machine status, alerts and messages. Navigation with the touchscreen provides access to menu items, machine information, settings and event logs. Setup and Energy Saver settings can be adjusted along with access to service and troubleshooting information.

Icons: Provide status indication and allow navigation by pressing the icon.

HOME SCREEN ICON DESCRIPTIONS

Icon	Description
<p>Home Screen</p> 	<p>Pressing this icon at any time will return the display to the home screen.</p> <p>State of ice Machine is the center portion of the screen which displays the current condition of the ice machine - Making ice, bin full, program mode or machine off</p>
<p>Alert</p> 	<p>Alert icon with number of messages. Pressing this icon will display the alert log which will allow viewing and resetting of alerts</p>
<p>Message</p> 	<p>Message icon with number of messages. Pressing this icon will display the routine maintenance reminder screen which will allow viewing and resetting of the reminder</p>
<p>Menu</p> 	<p>Menu icon will take you to the main menu</p>
<p>Information</p> 	<p>Information icon provides model and serial number, installation date and other information specific to the ice machine</p>
<p>Service Locator</p> 	<p>Provides contact information for your local service support - Default is the Manitowoc Ice website service locator</p>
<p>Lock/Unlock</p> 	<p>Indicates if screen is locked or unlocked</p>
<p>LuminIce</p> 	<p>Only visible when a LuminIce II accessory is connected.</p> <p>Blue S - Normal operation Red S - Replace bulb Red/Blue alternating - Incorrect bulb installed</p>

Setup Wizard





Screens will automatically advance after a selection is made or press the arrows to advance/go back one screen. All settings can be accessed and changed without the wizard by using menu screen navigation.

Setup	Description
Press ON/OFF Button	On/Off button is used to start/stop ice making.
Select Language	Default is English. Scroll to select a different language.
Start Wizard	Setup wizard will guide ice machine programming.
Date and Time Configuration	Select Month/Day/Year or Day/Month/Year. Select 12 hour or 24 hour time format.
Set Local Time	Use arrows to set local time.
Verify Date	Use arrows to set date for your location.
Accessory Detection	Detects if Ice Level Sensor, LuminIce II or iAuCS are connected. Checkmark = yes - X = no
Optional USB Settings Download	Only used when setup features have been transferred to a USB drive. Skip screen by selecting right arrow.
Configure Units	Select standard or metric.
Set Brightness	Configure screen brightness during normal operation.
Optional Ice Program	Program ice machine run times or press right arrow to skip this setup.
Optional Cleaning Reminder	Set clean and sanitize reminder or press right arrow to skip.
Optional Clean Air Filter Air-cooled models only	Set to ON for self-contained air cooled models.
Optional Water Filter Reminder	Select Yes or No.
Water Usage Option	Factory default - or - Use less water for reverse osmosis systems (see "Reverse Osmosis or Deionized Water Usage" on page 147) - or - Use more water to improve clarity for unfiltered water.
Congratulations	Setup wizard is complete.
Turn On Ice Machine	Turn on ice machine by pressing the On/Off button.





Menu Navigation Overview





SETTINGS MENU SCREEN NAVIGATION









Select SETTINGS Icon from the Home Screen to access Main Menu screen. The main menu screen contains four main headings, which allow access to subheadings under each main heading.

	Energy
	Ice Program
	Continuous Mode - Default, No Program
	Time Program - Select Daily On/Off times
	Weight Program - Select Daily Production Weight
	Water Usage
	Use Factory Default
	Use Less Water With Reverse Osmosis
	Use More Water To Improve Ice Clarity
	Statistics
	Ice Production - Previous 7 Days
	Water Usage - Previous 7 Days
	Energy Usage - Previous 7 Days

NOTE: The performance statistics are calculated based on the performance of the ice machine at 90°F (32°C) ambient temperature and 70°F (21°C) water temperature. The actual statistics will vary dependent on your environmental conditions.

	Service
	<p>Data</p> <p>Real Time Data</p> <p>Time and Temperature</p> <p>Inputs</p> <p>Outputs</p> <p>Data History for 5 Previous Days Minimum and Maximum Freeze (Length, Time of day, Thermistor Temperatures) Minimum and Maximum Harvest (Length, Time of day, Thermistor Temperatures)</p> <p>Lifetime Data History Installation Date Control Board Replacement Date Control Board Manufacture Date Runtime Cycle Count Potable Water Clean Cycles</p>
	<p>Alert Log</p> <p>Lists/Clears Alerts</p>
	<p>Manual Harvest</p> <p>Off or On</p>
	<p>Control Board Replacement</p> <p>Manual Replacement Manually enter model number Manually enter serial number Manually enter condenser serial number (optional) Verification</p> <p>USB Replacement Import to ice machine Export to USB</p>

	Service
	<p>Diagnostics</p> <ul style="list-style-type: none"> Control board Enable All Relays Self Check Temperature Sensors <ul style="list-style-type: none"> Lists Sensor Temperatures Inputs <ul style="list-style-type: none"> Lists Control Board Input Information User Interface <ul style="list-style-type: none"> Screen Calibration Button Diagnostics Screen Diagnostics Screen Calibration
	<p>Contact information</p> <ul style="list-style-type: none"> Factory defaults to QR code and website address to Manitowoc Ice's Global Locator. Edit Contact Information Button.
	<p>USB</p> <ul style="list-style-type: none"> Upgrade Firmware Export Data
	<p>iAuCS</p> <ul style="list-style-type: none"> Manually initiate the iAuCS pump for pump/hose priming. NOTE: The clean button does not initiate the iAuCS pump.

	Settings
	Language
	Select Language
	Reminders
	Clean Reminder
	Set Month Interval
	Air Filter
	Set On/Off/Interval
	Water Filter
	Set Reminder
	Configure Date & Time
	Configure Date & Time
	Set Time
	Set Date
	Units
	Standard or Metric
	Brightness
	Adjust Touch Screen Brightness For Sleep Mode or Inactivity. NOTE: 100% brightness is activated by touching the screen when the lock feature is off.
	USB
	Import Settings To Ice Machine
	Export Settings To USB
	iAuCS
	When the iAuCS is detected, the icon will appear in the settings menu to set frequency of cleanings with iAuCS

	Reset Defaults
	Require Setup Wizard Optional Setup Wizard restart for training purposes or resale of equipment.
	Backup Current Settings
	Import To Ice Machine
	Export To USB
	Reset Factory Defaults

EVENT LOG

Refer to “Event Log Detail” For Code descriptions.

Displayed Text	Code	Description
Long Freeze	E01	Long Freeze Cycle
Long Harvest	E02	Long Harvest Cycle
Power Loss	E03	Input Power Loss
Hi Cnd Temp or Wtr Cnd Fault	E04	High Condenser Temperature
HPC Fault	E05	High Pressure Control Opened
	E06	Spare
Starving TXV	E07	Starving TXV Single Evaporator or Low On Charge
TXV Fault	E08	TXV Fault Single or Dual Circuit Evaporators
Flood Evap1	E09	Flooding Evaporator Fault Single Evaporator, Single Circuit
Flood Evap2	E10	Flooding Evaporator Fault Dual TXV, Dual Circuit
Refrig Fault	E11	Refrigeration Fault
Curtain Fault	E12	Curtain Switch Fault - Open more than 24 hours
	E13	Spare
	E14	Spare
Low liq temp	E15	Fan Cycle Control Fault - Low Liquid Line Temperature
Rmt Cnd Fault	E16	Remote Condensing Unit Fault (CVD Only)
	E17	Spare
	E18	Spare
ITP Fault	E19	Ice Thickness Probe Fault
WTR Fault	E20	Water System Fault
T1 Fault	E21	T1 Temperature Sensor Issue
T2 Fault	E22	T2 Temperature Sensor Issue
T3 Fault	E23	T3 Temperature Sensor Issue
T4 Fault	E24	T4 Temperature Sensor Issue
Bin Probe Fault	E25	Bin Level Probe Low Sensor Fault
AUCS	E26	T6 or T7 Temperature Sensor Issue
USB COMM	E27	T6 or T7 Temperature Sensor Issue
USB DNLD	E28	iAuCS
	E29	USB Communication Fault
	E30	USB Download Fault
Safe Mode	E31	Safe Mode
RS485 COMM	E32	RS485 Communication Fault
Keyboard	E33	Touchscreen Fault
Display	E34	Display Fault

Displayed Text	Code	Description
Checksum	E36	Check Sum Error
WatchDog	E37	Watch Dog Event
UI Comm	E38	UI Comm Event

EVENT LOG DETAIL

E01 Long Freeze

6 consecutive 35 minute freeze cycles = Ice machine is off.

E02 Long Harvest

3 consecutive 7minute harvest cycles = Ice machine is off.

E03 Power Loss

When power is interrupted to the ice machine the control board will log the event in the ELOG and stamp the loss of power on power-up.

E04 High Condenser Temperature

Liquid Line Temperature too High for Self-contained Air Cooled Ice machine = Air Cooled Condenser Fault

Or

Liquid Line Temperature too High for Self-contained Water Cooled ice machine = Water Cooled Condenser Fault

E05 High Pressure Control Opened

The high pressure cutout switch (HPCO) opened.

E06 Spare

E07 Starving TXV Single Evaporator or Low On Charge

The difference of the average evaporator inlet (T3) and outlet (T4) is greater than 12°F in the last 1 minute of the freeze cycle.

E08 TXV Fault Single or Dual Circuit Evaporators

The difference of the average evaporator inlet (T3) and outlet (T4) is greater than 12°F in the last 1 minute of the freeze cycle.

E09 Flooding Evaporator Fault Single Evaporator, Single Circuit

Average compressor discharge line temperature during the first 6 minutes of the freeze cycle (T2) compared to the average of the Prechill (T1) +50°F is less than 1.05°F.

E10 Flooding Evaporator Fault Dual TXV, Dual Circuit

Average compressor discharge line temperature during the first 6 minutes of the freeze cycle (T2) compared to the average of the Prechill (T1) +50°F is less than 1.05°F.

E11 Refrigeration Fault

The compressor discharge temperature did not increase by at least 10° F, and the evaporator temperature did not decrease by at least 10° F - Measured from Refrigeration Start up or Prechill until 2 minutes into the Freeze cycle.

E12 Curtain Switch Fault Open more than 24 hours

The ice machine is set to ice making and remains in bin full condition for more than 24 hours. The curtain switch is open or curtain is off.

E13 Spare

E14 Spare

E15 Fan Cycle Control Fault - Low Liquid Line Temperature

The liquid line temperature dropped below 60° F for more than one continuous minute during the freeze cycle.

E16 Remote Condensing Unit Fault (CVD Only)

The liquid line temperature dropped below 40°F, or exceeded 140°F for more than 1 continuous minute during the freeze cycle.

E17 Spare

E18 Spare

E19 Ice Thickness Probe Fault

The monitored Frequencies is out of the appropriate range (probe unplugged or problem with microphone).

E20 Water System Fault

Any of the following:

1. Sensing high water probe and not low water probe.
2. Evaporator outlet temperature is less than -10°F 6.5 to 7.5 minutes in freeze cycle.
3. Low water probe is satisfied at the end of harvest.
4. Low or high water probe is satisfied at end of freeze cycle.

E21 T1 Temperature Sensor Issue

During Pre-chill the thermistor had an average value reading outside the valid range.

E22 T2 Temperature Sensor Issue

During Pre-chill the thermistor had an average value reading outside the valid range.

E23 T3 Temperature Sensor Issue

During Pre-chill the thermistor had an average value reading outside the valid range.

E24 T4 Temperature Sensor Issue

During Pre-chill the thermistor had an average value reading outside the valid range.

E25 Bin Level Probe Low Sensor Fault

The thermistor had an average value reading outside of the valid range for 10 continuous minutes.

E26 T6 or T7 Temperature Issue

The thermistor had an average value reading outside of the valid range.

E27 T6 or T7 Temperature Issue

The thermistor had an average value reading outside of the valid range.

E28 iAuCS

When the iAuCS clean option is selected from the menu, the control checks for the presence of the iAuCS board. When the iAuCS is not connected it will signal an Event which will clear as soon as the hardware is detected.

E29 USB Communication Fault

USB Communication error; No USB drive in port or defective USB drive.

E30 USB Download Fault

USB Download error related to USB drive or a defective USB drive.

E31 Safe Mode

Safe mode allows the ice machine to operate for a period of time in the event of a Water level or ice thickness probe failure. The controller allows the machine to operate based on model data and historical cycle information.

E32 RS485 Communication Fault

The device plugged into the RS485 port is not communicating between the control board and gateway.

E33 Touchscreen Fault

The Touchscreen is not plugged into the control board or is faulty.

E34 Display Fault

The touchscreen is not plugged into the control board or is faulty.

E36 Check Sum Error

Event Log Only: Activates on power loss.

E37 Watch Dog Event

Event Log Only: Micro Process time out, possible electrical noise.

E38 UI Comm Event

Event Log Only: User interface communication error: loose communication cable, power interruption.

USB FLASH DRIVE SPECIFICATIONS AND FORMATTING

Updating firmware on Indigo™ model ice machines requires a properly formatted 32 GB or smaller USB flash drive. All USB flash drives must be formatted before use to remove any software programs or files currently on the flash drive.

USB Flash Drive Specifications:

- USB 2 Version
- 32 GB or less capacity
- Fat32 File System

USB Flash Drive Formatting:

Procedure to format a USB flash drive varies with operating system software. Refer to operating system software manufacturer's website for formatting instructions.

UPGRADING FIRMWARE WITH A FLASH DRIVE

Important

The flash drive must be formatted before using. All files and software on the flash drive are removed during the formatting process.

1. Drag and drop the files from website or email onto a flash drive, insuring they are not in a folder.
2. Ensure that the ice machine's power is on.
3. Navigate to USB - Menu/Service/USB.
4. Insert the flash drive into the USB port on the ice machine control board. Do not remove flash drive until update is complete.

NOTE: See "Electronic Control Board" on page 236 for USB location.

5. Select "Upgrade firmware" and remove USB drive when the transfer is complete.

EXPORTING DATA TO A FLASH DRIVE

Data can be copied from the control board memory to a flash drive and used to transfer setup and/or cycle data to a replacement control board or to transfer setup information to multiple ice machines. Data may also be requested by service department personnel for analysis or as an aid to troubleshooting. The data files are small and can be attached to an email.

Important

The flash drive must be formatted before using. All files and software on the flash drive are removed during the formatting process.

1. Ensure that the ice machine's power is on.
2. Press the Menu button.
3. Navigate to USB - Menu/Service/USB.
4. Insert the flash drive into the USB port on the ice machine control board. Do not remove flash drive until transfer is complete.
5. Select "Export Data" (do not remove flash drive until update is complete) and remove USB drive when the transfer is complete.

THIS PAGE INTENTIONALLY LEFT BLANK

Component Check Procedures

Electrical Components

CONTROL BOARD, DISPLAY AND TOUCHSCREEN

FUNCTION

The control board, display and touch screen provide user input and control the ice machine sequence of operation.

NOTE: Anytime power is supplied to wires #55 & #56 on the control board, the "Display" and "Micro" lights will flash on and off. The two green lights are located on the top corner of the control board.

Display Diagnostics

Symptom - Micro light flashes and display light is off.

1. Reboot ice machine by disconnecting power for a minimum of 15 seconds, reapplying power and checking micro light for normal flashing.
2. Disconnect the display module communication cable from the control board and inspect for damaged or corroded pins. Reconnect after inspection.
3. Press the power button on the display and watch the green Display light on the control board.
 - A. Display light flashes - Test run ice machine.
 - B. Display light is off - Replace display/touch pad assembly.

Control Board Diagnostics

1. Micro light is not flashing.
2. Disconnect line voltage power supply to the ice machine and wait a minimum of 15 seconds, then reapply power.
 - A. Micro light flashes - continue with step 3.
 - B. Micro light is off - Test fuse for continuity. If fuse tests good replace control board.
3. Perform a control board self-test.
 - Menu/Service/Diagnostics/Control Board/Self Check.

The control board performs a self test. As the test progresses the display will show pass or fail as the tests are completed.

- Status passed -The control board is functioning normally, continue with touch pad diagnostics on next page.
- Status failed - Replace control board.

Touchscreen Diagnostics

Verify touchscreen is unlocked prior to performing diagnostics.

1. Navigate to User Interface on the display and perform the on-screen instructions.
 - Menu/Service/Diagnostics/User Interface.

NOTE: During screen calibration it is important to touch and hold down the cross hairs for three seconds at a time.

2. The calibration will either pass or fail. If the touchscreen fails calibration and will not function correctly in other menu functions replace the touchscreen module.

NOTE: Verify you have followed all of the instructions for screen calibration. Skipping steps will result in a failed calibration message.

Important

The ice machine can be run without a touchscreen by pressing the test button on the control board.

CONTROL BOARD RELAY TEST

The control board can be set to energize all relays for 3.5 minutes. This allows testing to verify control board relays are closed and line voltage is available for ice machine components - Water pump, dump valve, water inlet valve, harvest valve(s), air compressor(s), contactor/compressor/fan motor - The fan cycle control must close to energize the fan motor.

1. Press power button to turn off ice machine and navigate in menu to enable all relays.
- Menu/Service/Diagnostics/Control Board/Enable All Relays.
2. The control board will energize all relays and the red light next to the relay. The red light indicates the relay coil is energized.
3. Test for line voltage at the individual components.
 - A. Line voltage is present and the component is non functional - Replace component
 - B. Voltage is not present at the component - Proceed to step 5
4. Refer to wiring diagram and determine wire location on the 9 pin molex connector for the component you are testing.
5. Check for line voltage at the control board 9 pin molex connector.
 - A. Line voltage at 9 pin connector - Repair wiring to component
 - B. No power at 9 pin connector - Replace control board

PROGRAMMING A REPLACEMENT CONTROL BOARD

Indigo™ replacement control boards require the Model number to be entered to activate the appropriate look up tables for operation and diagnostic. This can be done two different ways, USB Setup or Manual Setup.

USB Setup - Applicable when the control board is operational and has a mechanical issue such as a sticking relay. The asset data is transferred to the replacement control board from the faulty control board. Refer to page 135 “Exporting Data To A Flash Drive” before installing the replacement board.

Manual Setup - Applicable when the control board is non-operational or data from the faulty board is suspect.

1. Install replacement control board and reapply power.
2. Navigate to control board replacement and follow the on screen prompts:

Menu/Service/Control Board Replacement.

NOTE: If a replacement control board is installed into the ice machine without a display and model number. The “Test/Display Bypass Button” push button can still activate the ice making mode without the display. This will allow the ice machine to temporary run until a new display can be installed. Once a new display is installed the correct model number will have to be entered into the ice machine.

MAIN FUSE

FUNCTION

The control board fuse stops ice machine operation if electrical components fail, causing high amp draw.

SPECIFICATIONS

The main fuse is 250 Volt, 6.3 amp.

⚠ Warning

High (line) voltage is applied to the control board (terminals #55 and #56) at all times. Removing the control board fuse or pressing the On/Off button will not remove the power supplied to the control board.

CHECK PROCEDURE

1. If the display is energized or the bin switch light is on with the water curtain/ice dampers closed, the fuse is good.

⚠ Warning

Disconnect electrical power to the entire ice machine before proceeding.

2. Remove the fuse. Check for continuity across the fuse with an ohmmeter.

Reading	Result
Open (OL)	Replace fuse
Closed (O)	Fuse is good

BIN SWITCH

FUNCTION

Movement of the water curtain/ice dampers control bin switch operation. The bin switch has two main functions:

1. Terminating the Harvest cycle and returning the ice machine to the Freeze cycle. This occurs when the bin switch is opened and closed again within 30 seconds during the Harvest cycle.
2. Automatic ice machine shut-off.
If the storage bin is full at the end of a Harvest cycle, the sheet of cubes fails to clear the water curtain/ice dampers and holds it open. After the water curtain/ice dampers are held open for 30 seconds, the ice machine shuts off. The ice machine remains off until enough ice is removed from the storage bin to allow the sheet of cubes to drop clear of the water curtain/ice dampers. As the water curtain/ice dampers swing back to the operating position, the bin switch closes and the ice machine restarts, provide the 3-minute delay has expired.

Important

The water curtain/ice dampers must be ON (bin switch closed) to start ice making.

SPECIFICATIONS

The bin switch is a magnetically operated reed switch. The magnet is attached to the lower right corner of the water curtain and both ends of ice dampers.

The bin switch is connected to a varying D.C. voltage circuit. (Voltage does not remain constant.)

NOTE: Because of a wide variation in D.C. voltage, it is not recommended that a voltmeter be used to check bin switch operation.

Diagnostics

SYMPTOMS

Bin Switch Fails Open

- The ice machine will not start an ice making cycle and the display indicates “Full Bin”.
- The ice machine displays “Full Bin Remove Ice” in the clean cycle.

Bin Switch Fails Closed

- When running a “Long Harvest” alert is displayed.
- May be off on a E02 Long Harvest.
- The harvest cycle continues after ice opens and closes the ice damper (harvest cycle is 3.5 minutes).
- A curtain fault is displayed in the event log.

DIAGNOSTICS

1. Verify bin switch, curtain/damper and curtain/damper magnet are in place and navigate to Inputs.
 - Menu/Service/Diagnostics/Inputs
2. Open and close the ice damper(s) repeatedly while observing the display and control board lights.
 - A. Curtain switch cycles open/closed - The display indicates open/closed and the control board light energizes/de-energizes - Bin switch is operating normally
 - B. Curtain switch remains closed, the display indicates closed and control board light remains on - Go to step 3
 - C. Curtain switch remains open, display indicates open and control board light remains off - Go to step 3
3. Disconnect bin switch wire from control board.
4. Jumper control board bin switch wire to ground, press the power button and observe the display and control board lights.
 - A. Curtain switch closes, display indicates closed, control board light energizes and the ice machine starts - Replace bin switch
 - B. Curtain switch remains open, display indicates open and the control board light is off - Verify procedure was correctly followed - Replace control board

WATER LEVEL CONTROL CIRCUITRY

FUNCTION

The water level probe controls the water level by sensing whether water is or is not contacting the water level probe. The water level probe has three sensing probes. Two probes are equal in length and are used to measure conductivity for diagnostics, ice clarity and water miser options. Factory default settings measure resistance from both long probes to the short probe.

SPECIFICATIONS

Freeze Cycle Water Level Setting

The water level is not adjustable. If the water level is incorrect, check the water level probe position. Reposition or clean the probe as necessary.

Water Inlet Valve Safety Shut-Off

In the event of a water level probe failure, this feature limits the maximum amount of time the water inlet valve can remain.

SINGLE EVAPORATOR MODELS

Regardless of the water level probe input, the control board automatically shuts off the water inlet valve if it remains on for 6 continuous minutes.

DUAL EVAPORATOR MODELS

Regardless of the water level probe input, the control board automatically shuts off the water inlet valve if it remains on for 8 continuous minutes.

Prechill & Freeze Cycle Operation

The water inlet valve energizes and de-energizes in conjunction with the water level probe located in the water trough.

- The water inlet valve is ON when there is no water in contact with the water level probes.
- The water inlet valve turns OFF after water contacts the water level probes for 6 continuous seconds.
- The water inlet valve can cycle ON and OFF once in the prechill and up to two times in the freeze cycle.
- Maximum fill time is:
 - Single evaporator 6 minutes.
 - Dual evaporator 8 minutes.

The water inlet valve energizes in the Prechill cycle and will de-energize if water touches the high level probe (in most instances the water trough can't fill in the prechill cycle and the water inlet valve will remain energized into the freeze cycle). The water inlet valve will remain energized until water contacts the high water probe. The water inlet valve will cycle ON, and then OFF one more time to refill the water trough. The water inlet valve is now OFF for the duration of the freeze cycle.

REVERSE OSMOSIS OR DEIONIZED WATER USAGE

When using water with low total dissolved solid content (low TDS) the water level probe sensitivity can be increased by moving the jumper over one pin (refer to "Electronic Control Board" on page 236 for location).

The Electronic Control Board diagrams shows the default position of the jumper covering the left and center pins. Moving the jumper to the center and right pins and enabling R.O. menu "Use less water with reverse osmosis" will increase the sensitivity of the water level probe.

Diagnostics

Check real time data

1. Navigate to Menu/Service/Diagnostics/Inputs
2. Focus on Water LVL Low and Water LVL High display
 - Not sensing displayed: indicates not touching water.
 - Sensing displayed: Indicates touching water.

NOTE: If using reverse osmosis or deionized water, increase sensitivity by moving the jumper over one pin (refer to “Electronic Control Board” on page 236) and enabling R.O. menu “Use less water with reverse osmosis”.

3. Disconnect the water level probe wiring harness from the control board and ohm harness and water level probe. Normal readings will show no resistance

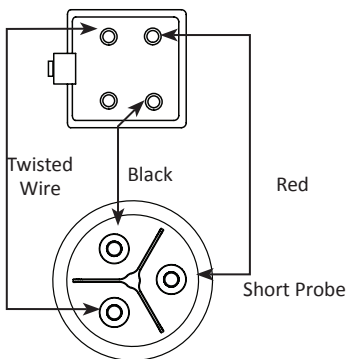

Ohm Water Level Probe and Wiring Harness

WATER LEVEL PROBE CIRCUIT CHECK AT CONTROL BOARD

Wait until prechill cycle starts, then jumper water level probe connections (Red/Black) on the control board.

- A. Sensing displays and the water stops. Repair wire or replace water level probe.
- B. Not Sensing displays and the water continues to flow. Replace control board.

ICE THICKNESS PROBE (INITIATES HARVEST)

FUNCTION

The ice thickness probe senses ice on the evaporator and signals the control board to start a harvest cycle.

SPECIFICATIONS

Freeze Time Lock-In Feature

The ice machine control system incorporates a 6 minute freeze time lock-in feature. This prevents the ice machine from short cycling in and out of harvest.

Maximum Freeze Time

The maximum freeze time is 35 minutes at which time the control board automatically initiates a harvest sequence.

Maximum Temperature

Maximum temperature for the ice thickness probe is 120°F (49°C). Do not clean probe in a dishwasher or expose to temperatures above the maximum.

Ice Thickness Check

The ice thickness probe is factory-set to maintain the ice bridge thickness at 1/8" (3 mm).

NOTE: Initial gap should be set with the ice machine off. Verify the water curtain/splash shields are in place when performing this check. It prevents water from splashing out of the water trough. Remove the curtain to make an adjustment, then replace immediately after the adjustment is made.

1. Inspect the bridge connecting the cubes. It should be about 1/8" (3 mm) thick.
2. If adjustment is necessary, turn the ice thickness probe adjustment screw clockwise to increase bridge thickness or counterclockwise to decrease bridge thickness. Set a 9/32" gap between the ice thickness probe and evaporator as a starting point. Then adjust to achieve 1/8" ice thickness.
3. Make sure the ice thickness probe wire and the bracket do not restrict movement of the probe.

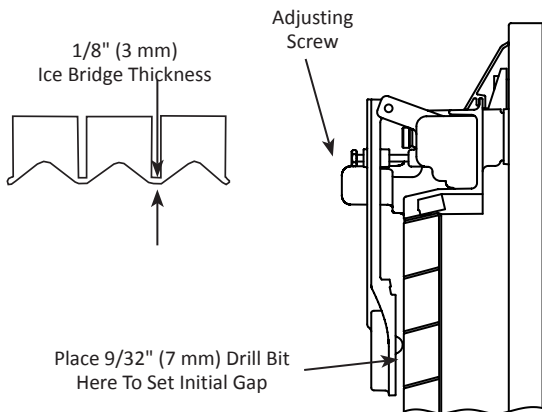

ICE THICKNESS ADJUSTMENT

Ice Thickness Probe Diagnostics

1. Perform Control Board Self Check and insure the internal ITP circuit passes before proceeding.

(Menu/Service/Diagnostics/Control Board/Self Check)

- Ice Thickness Circuit: Pass = Continue with step #2.
 - Ice Thickness Circuit: Fail = Change control board.
2. Remove all ice from the evaporator when present.
 3. Press the power button and turn off the ice machine.
 4. Disconnect power to the ice machine at the main disconnect.
 5. Inspect the ice thickness probe for physical damage. On the face of the probe look for bulging, cracks around the nipple and deformed pivot pins or pivot pin arms.
 6. Verify the ice thickness probe gap is approximately 9/32" (7 mm) and the ice thickness probe wire and bracket do not restrict movement of the probe. See "Ice Thickness Check" on page 150.
 7. Reapply power to the ice machine at the main disconnect and confirm the ice machine is off.
 8. Navigate to Real Time data (Menu/Service/Data/Real Time data/Inputs) and observe ITP FFT 100 Hz & 120 Hz.
 9. Observe the initial number range and perform a tap test.
- Remove the water curtain or splash shield if present.
 - Lift the ice thickness probe and carefully tap the nipple on the face of the probe for at least 10 seconds.

NOTE: When performing tap test:

- Pass = ITP is not the problem
- Fail = Check DC Voltage on the control board

The initial numbers displayed are constantly changing and are greater than 3000.

When the initial reading is 300 or lower and the tap test reading exceeds the initial reading by 3000 or more, the ice thickness probe and control board are both operating correctly.

The initial numbers displayed do not change or initial numbers did not increase by 3000 during tap test.

- Verify the ice thickness probe connector is properly plugged into the board and the ice thickness probe wiring is correct. If the wiring is incorrect replace the ice thickness probe.

Ice Probe Connector On Control Board	
Pin 1 (+)	Red
Pin 2 (-)	Black
Pin 3	Twisted Wire

10. Unplug the ice thickness probe and set a VOM to DC voltage scale - Measure voltage across Pin 1 (+) Red Wire and Pin 2 (-) Black Wire. Refer to "Electronic Control Board" on page 236.
 - A. Voltage measures 3.25 to 3.35 VDC = Replace ice thickness probe.
 - B. Voltage does not measure 3.25 to 3.35 VDC = Replace the control board.

HIGH PRESSURE CUTOUT (HPCO) CONTROL

FUNCTION

Stops the ice machine if subjected to excessive high-side pressure. The HPCO control is normally closed, and opens on a rise in discharge pressure.

SPECIFICATIONS

Specifications		
Refrigerant	Cut-Out	Cut-In
R410A	600 psig \pm 10 (3147 kPa \pm 69)	450 psig \pm 10 (3103 kPa \pm 69)
R404A	450 psig \pm 7 (3102 kPa \pm 48)	300 psig \pm 10 (2068 kPa \pm 69)
Automatic Reset		

SYMPTOM

Opening the HPCO will cause the control board to initiate a 10 minute delay after which the ice machine attempts a restart. If the HPCO is closed the ice machine will continue to run. If the HPCO remains open after the 10 minute delay or reopens when the compressor starts, the ice machine will start another 10 minute delay period.

1. Machine is off and the Alert Log indicates E5 HPC Trip, the number of trips and the time and date of the last trip.
2. Machine is running and the display has an alert notification - Select the Alert Log to display the fault.

CHECK PROCEDURE

Symptom #1 Machine is off and the display indicates an E5 HPC Trip in the Alert Log.

1. Install a manifold gauge set.
2. Start a new freeze cycle by cycling the power button.
3. Run the system to see if the control trips at the rated pressure. If HPCO opens at a pressure significantly lower or higher than the control setting replace the HPCO.
4. If the control opens at the correct pressure find the root cause - Fan motor, dirty condenser, refrigeration system issue, etc. The ice machine will go to an initial start sequence if the HPCO is closed. If the HPCO is open, another 10 minute delay period starts. When the compressor relay closes the control board checks the HPCO.

Symptom #2 Machine is running and the display has an alert indication.

1. The display indicates an E5 HPC Trip in the Alert Log. Open the event and view when and how often HPCO Fault has occurred.
2. If this is a one time event it may be intermittent and caused by conditions around the unit changing. For example: High ambient temperature, water turned off to condenser (water cooled unit) etc.
3. Run the system to see if the control trips at the rated pressure. If HPCO opens at a pressure significantly lower than the control setting replace the HPCO.
4. If the control opens at the correct pressure find the root cause - Fan motor, dirty condenser, refrigeration system issue, etc.

FAN CYCLE CONTROL

FUNCTION

Cycles the fan motor on and off to maintain proper operating discharge pressure.

The fan cycle control closes on an increase, and opens on a decrease in discharge pressure.

SPECIFICATIONS

Specifications		
Model	Cut-In (Close)	Cut-Out (Open)
IT0420/IT0500/IT0620 IT1200/IT1500/IT1900	335 psig ± 5 (2310 kPa ± 34)	275 psig ± 5 (1896 kPa ± 34)
IF0600	250 psig ± 5 (1723 kPa ± 34)	200 psig ± 5 (1517 kPa ± 34)
IF0900	275 psig ± 5 (1896 kPa ± 34)	225 psig ± 5 (1551 kPa ± 34)

CHECK PROCEDURE

1. Verify fan motor windings are not open or grounded, and fan spins freely.
2. Connect manifold gauge to ice machine.
3. Hook voltmeter in parallel across the fan cycle control, leaving wires attached.
4. Refer to chart below.

FCC Set-point:	Reading Should Be:	Fan Should Be:
Above Cut-In	0 Volts	Running
Below Cut-Out	Line Voltage	Off

THERMISTORS

FUNCTION

Thermistor resistance values change with temperature. The value supplied to the control board is used to identify temperature at the thermistor location.

SPECIFICATIONS

Temperature of Thermistor		Resistance
°C	°F	K Ohms (x 1000)
-30° – -20°	-22° – -4°	820.85 – 466.35
-20° – -10°	-4° – 14°	466.35 – 269.05
-10° – 0°	14° – 32°	269.05 – 160.70
0° – 10°	32° – 50°	160.70 – 98.930
10° – 20°	50° – 68°	98.930 – 62.015
20° – 30°	68° – 86°	62.015 – 39.695
30° – 40°	86° – 104°	39.695 – 25.070
40° – 50°	104° – 122°	25.070 – 17.481
50° – 60°	122° – 140°	17.481 – 11.860
60° – 70°	140° – 158°	11.860 – 8.1900
70° – 80°	158° – 176°	8.1900 – 5.7530
80° – 90°	176° – 194°	5.7530 – 4.1015
90° – 100°	194° – 212°	4.1015 – 2.9735
100° – 110°	212° – 230°	2.9735 – 2.1885
110° – 120°	230° – 248°	2.1885 – 1.6290
120° – 130°	248° – 266°	1.6290 – 1.2245
130° – 140°	266° – 284°	1.2245 – 0.9319
140° – 150°	284° – 302°	0.9319 – 0.7183
150° – 160°	302° – 320°	0.7183 – 0.5624
160° – 170°	320° – 338°	0.5624 – 0.4448
170° – 180°	338° – 356°	0.4448 – 0.3530
180° – 190°	356° – 374°	0.3530 – 0.2831
190° – 200°	374° – 392°	0.2831 – 0.2273

Thermistor Matrix

Four thermistors are standard on the ice machine. They are labeled T1, T2, T3, T4.

TEMPERATURE SENSOR LOCATION SELF CONTAINED AIR OR WATER COOLED MODELS

22" & 30" Models with 1 evaporator, 1 evaporator circuit and an air or water cooled condenser

T1 - Condenser Liquid Line

T2 - Compressor Discharge

T3 - Evaporator Inlet

T4 - Evaporator Outlet

30" & 48" Models with 1 evaporator, 2 evaporator circuits and an air or water cooled condenser

T1 - Condenser Liquid Line

T2 - Compressor Discharge

T3 - Evaporator Outlet for second evaporator circuit

T4 - Evaporator Outlet for first evaporator circuit

TEMPERATURE SENSOR LOCATION REMOTE AIR
COOLED CONDENSER MODELS

30" Models with 1 evaporator, 1 evaporator circuit and a remote air cooled condenser

T1 - Receiver Inlet

T2 - Compressor Discharge

T3 - Evaporator Inlet

T4 - Evaporator Outlet

30" & 48" Models with 1 evaporator, 2 evaporator circuits and a remote air cooled condenser

T1 - Receiver Inlet

T2 - Compressor Discharge

T3 - Evaporator Outlet for second evaporator circuit

T4 - Evaporator Outlet for first evaporator circuit

SYMPTOM

Alert icon on the display and the alert indicates a T1, T2, T3, or T4 Fault.

CHECK PROCEDURE

Navigate to Menu/Service/Data/Real Time data/Time & Temperature

NOTE: An open thermistor will display -22°F (-30°C) and a shorted thermistor displays 475°F (246°C).

Thermistor Test

1. Disconnect thermistor from control board and measure resistance.
2. Measure temperature at the thermistor.
3. Compare measured resistance/temperature readings to resistance/temperature relationship chart.
 - A. Within 10% of the published resistance value - Thermistor is good.
 - B. Not within 10% of the published resistance value - Thermistor is defective.

Control Board Test

1. Disconnect thermistor from control board - The display temperature reading, dropping to -22°F (-30°C) indicates the control board is good.
2. Short thermistor pins - The display temperature reading, climbing to 475°F (246°C) indicates the control board is good.

HARVEST ASSIST AIR PUMP

FUNCTION

The air pump helps break the vacuum between the sheet of ice and the evaporator which results in shorter harvest cycles.

SPECIFICATIONS

115 Volt or 230 Volt - matches the ice machine voltage.

CHECK PROCEDURE

1. The air pump is wired in parallel with the harvest valve - Verify the ice machine is in the harvest cycle and the harvest valve is energized.
2. If there is voltage at the air pump connector, use a volt ohm meter to verify there is no continuity through the motor windings then replace motor.

COMPRESSOR ELECTRICAL DIAGNOSTICS

The compressor does not start or will trip repeatedly on overload.

Check Resistance (Ohm) Values

NOTE: Compressor windings can have very low ohm values. Use a properly calibrated meter.

Perform the resistance test after the compressor cools. The compressor dome should be cool enough to touch (below 120°F/49°C) to assure that the overload is closed and the resistance readings will be accurate.

SINGLE PHASE COMPRESSORS

1. Disconnect power then remove the wires from the compressor terminals.
2. The resistance values between C and S and between C and R, when added together, should equal the resistance value between S and R.
3. If the overload is open, there will be a resistance reading between S and R, and open readings between C and S and between C and R. Allow the compressor to cool, then check the readings again.

THREE PHASE COMPRESSORS

1. Disconnect power and remove the wires from the compressor terminals.
2. The resistance values between L1 and L2, between L2 and L3, and between L3 and L1 should all be equal.
3. If the overload is open, there will be open readings between L1 and L2, between L2 and L3, and between L3 and L1. Allow the compressor to cool, then check the readings again.

CHECK MOTOR WINDINGS TO GROUND

Check continuity between all three terminals and the compressor shell or copper refrigeration line. Scrape metal surface to get good contact. If continuity is present, the compressor windings are grounded and the compressor should be replaced.

COMPRESSOR DRAWING LOCKED ROTOR

To determine if the compressor is seized, check the amp draw while the compressor is trying to start.

The two likely causes of this are a defective starting component or a mechanically seized compressor.

To determine which you have:

1. Install high and low side gauge.
2. Try to start the compressor.
3. Watch the pressures closely.
 - A. If the pressures do not move, the compressor is seized. Replace the compressor.
 - B. If the pressures move, the compressor is turning slowly and is not seized. Check the capacitors and relay.

COMPRESSOR DRAWING HIGH AMPS

The continuous amperage draw on start-up should not be near the maximum fuse size indicated on the serial tag.

DIAGNOSING START COMPONENTS

If the compressor attempts to start, or hums and trips the overload protector, check the start components before replacing the compressor.

Capacitor

Visual evidence of capacitor failure can include a bulged terminal end or a ruptured membrane. Do not assume a capacitor is good if no visual evidence is present. A good test is to install a known good substitute capacitor. Use a capacitor tester when checking a suspect capacitor. Clip the bleed resistor off the capacitor terminals before testing.

Relay

The relay has a set of contacts that connect and disconnect the start capacitor from the compressor start winding. The contacts on the relay are normally closed (start capacitor in series with the start winding). The relay senses the voltage generated by the start winding and opens the contacts as the compressor motor starts. The contacts remain open until the compressor is de-energized.

RELAY OPERATION CHECK

1. Disconnect wires from relay terminals.
2. Verify the contacts are closed.
Measure the resistance between terminals 1 and 2. No continuity indicates open contacts. Replace the relay.
3. Check the relay coil.
Measure the resistance between terminals 2 and 5. No resistance indicates an open coil. Replace the relay.

PTCR

The PTCR allows current to flow through the start winding at compressor startup. Current flow heats the ceramic discs in the PTCR. The electrical resistance increases with temperature and stops all except a trickle of current flow through the start winding. The small flow of current keeps the PTCR hot (260°F/127°C) and the start winding out of the circuit.

The PTCR must be cooled before attempting to start the compressor, otherwise the PTCR will heat up too quickly and stop current flow through the start winding before the compressor motor reaches full speed.

Warning

Disconnect electrical power to the entire ice machine at the building electrical disconnect box before proceeding.

NOTE: If a PTCR is dropped internal damage can occur to the ceramic PTCR discs. The ceramic disc can chip and cause arcing which leads to PTCR failure. Since there is no way to open the PTCR in order to determine if the ceramic disc is chipped or not, it must be discarded when dropped.

PTCR Operation Check

1. Visually inspect the PTCR. Check for signs of physical damage.

NOTE: The PTCR case temperature may reach 210°F (100°C) while the compressor is running. This is normal. Do not change a PTCR just because it is hot.

2. Wait at least 10 minutes for the PTCR to cool to room temperature.
3. Remove the PTCR from the ice machine.
4. Measure the resistance of the PTCR as shown. The resistance reading must be between:

Model	Ohm Value	Amp	Part Number
IT0420/IT0450 IT0500/IT0620 IT1200A/IT1200W	10.5 to 19.5	12	000014323
IT1200N	24.5 to 45.5	10	8505003
IF0600/IF0900 IT1500/IT1900	21 to 39	18	8504993

Measure Resistance at Ends

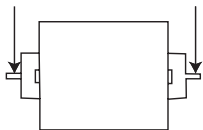

Two Terminal PTCR

Measure Resistance at Center and End

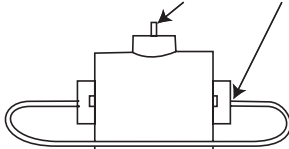

Leave Jumper Wire Attached

Three Terminal PTCR

Refrigeration Components

HEADMASTER

Manitowoc remote systems require head pressure control valves with special settings. Replace defective head pressure control valves only with “original” Manitowoc replacement parts.

Refrigerant Charge Verification

The correct amount of refrigerant (name plate charge) is required to operate correctly at all ambient conditions.

An ice machine with an overcharge or undercharge of refrigerant may function properly at higher ambient temperatures and fails at lower ambient temperatures. Symptoms of incorrect refrigerant amount are:

- Works during the day and malfunctions at night, and/or fails whenever the outdoor temperature drops.
- A Service Fault is stored in control board memory.

Refrigerant loss and ambient temperature are directly related to each other. As the ambient temperature drops, more refrigerant is stored in the condenser.

When the refrigerant charge and ambient temperature create an undercharge of refrigerant in the freeze cycle, the receiver dip tube will lose its liquid seal. Without liquid refrigerant to the TXV, the ice machine fails to make a full sheet of ice in 35 minutes and a Long Freeze results.

NOTE: When a head pressure control valve is being replaced or refrigerant charge is suspected, verify the refrigerant charge is correct by recovering the refrigerant, weighing and comparing to the nameplate amount. Refer to “Refrigerant Recovery/Evacuation” on page 181 for recovery procedures.

Freeze Cycle Operation All Remote Condenser Models

The headmaster is non adjustable.

At ambient temperatures of approximately 70°F (21°C) or above, refrigerant flows through the valve from the condenser to the receiver inlet. At temperatures below this (or at higher temperatures if it is raining), the head pressure control dome's nitrogen charge closes the condenser port and opens the bypass port from the compressor discharge line.

In this modulating mode, the valve maintains minimum head pressure by building up liquid in the condenser and bypassing discharge gas directly to the receiver.

Harvest Cycle Operation

Remote Condenser Models

The head pressure control cycles into full bypass due to the pressure drop when the harvest valve opens. Refrigerant flows from the compressor to the evaporator through the harvest valve and the head pressure valve is out of the circuit.

Diagnostics

FREEZE CYCLE - REMOTE CONDENSER

1. Determine if the coil is clean.
2. Determine the air temperature entering the condenser.
3. Determine if the head pressure is high or low in relationship to the outside temperature. (Refer to the proper "Cycle Times/24-Hour Ice Production/Refrigerant Pressure Charts" page 195).
4. Determine the temperature of the liquid line entering the receiver by feeling it. This line is normally warm; "body temperature."
5. Using the information gathered, refer to the chart.

NOTE: A head pressure control valve that will not bypass, will function properly with condenser air temperatures of approximately 70°F (21°C) or above. When the temperature drops below 70°F (21°C), the head pressure control valve fails to bypass and the ice machine malfunctions. Lower ambient conditions can be simulated by rinsing the condenser with cool water during the freeze cycle.

Condition	Probable Cause	Corrective Measure
Discharge Pressure - High Liquid Line Temperature - Hot	Valve stuck in bypass	Replace valve
Discharge Pressure - Low Liquid Line Temperature - Cold	Valve not bypassing	Replace valve
Discharge Pressure - Low Liquid Line Temperature - Hot	Ice Machine Low on Charge	Refrigerant Charge Verification

Harvest Cycle

REMOTE CONDENSER

The head pressure control cycles into full bypass due to the pressure drop when the harvest valve opens. Refrigerant flows from the compressor to the evaporator through the harvest valve and the head pressure valve is out of the circuit.

Undercharge Symptoms

- Long Freeze or Long Harvest in control board memory and an alert indicating Long Freeze or Long Harvest.
- Harvest cycle suction pressure is low.
- Harvest cycle discharge pressure is low.
- Liquid line entering receiver feels warm to hot in the freeze cycle.

Overcharge Symptoms

- Long Harvest in control board memory and an alert indicating Long Harvest is displayed.
- Harvest cycle discharge pressure is normal.
- Freeze cycle time, suction and discharge pressure are normal and the ice machine will not harvest. The sheet of ice cubes show little or no sign of melting when removed from the evaporator after the harvest cycle has been completed. (If the cubes are melted you have a release problem, clean the ice machine.)

HARVEST PRESSURE REGULATING (HPR) SYSTEM REMOTE CONDENSER ONLY

GENERAL

The harvest pressure regulating (HPR) system includes:

- Harvest pressure regulating solenoid valve (HPR solenoid). This is an electrically operated valve which opens when energized, and closes when de-energized. The HPR solenoid valve is wired in parallel with the harvest valve.
- Harvest pressure regulating valve (HPR valve). This is a pressure regulating valve which modulates open and closed, based on the refrigerant pressure at the outlet of the valve. The valve closes completely and stops refrigerant flow when the pressure at the outlet rises above the valve setting.

FREEZE CYCLE

The HPR system is not used during the freeze cycle. The HPR solenoid is closed (de-energized), preventing refrigerant flow into the HPR valve.

HARVEST CYCLE

During the harvest cycle, the check valve in the discharge line prevents refrigerant in the remote condenser and receiver from back feeding into the evaporator and condensing to liquid.

The HPR solenoid is opened (energized) during the harvest cycle, allowing refrigerant gas from the top of the receiver to flow into the HPR valve. The HPR valve modulates open and closed, raising the suction pressure high enough to sustain heat for the harvest cycle, without allowing refrigerant to condense to liquid in the evaporator.

In general, harvest cycle suction pressure rises, then stabilizes. Exact pressures vary from model to model. Refer to cycle time/24 hour ice production and operational pressure charts.

HPR DIAGNOSTICS

Steps 1 through 5 can be quickly verified without attaching a manifold gauge set or thermometer.

All questions must have a yes answer to continue the diagnostic procedure.

1. Liquid line warm?
(Body temperature is normal)
If liquid line is cooler than body temperature, refer to “Headmaster” on page 167.
2. Ice fill pattern normal?
Refer to “Ice Formation Pattern” on page 95.
3. Freeze time normal?
“Cycle Times/24-Hour Ice Production/Refrigerant Pressure Charts” on page 195.
Shorter freeze cycles - Refer to “Headmaster” on page 167.
Longer freeze cycles - Refer to “Water System Checklist” on page 93 then refer to “Troubleshooting By Symptom” on page 75.
4. Harvest time is longer than normal and control board indicates Long Harvest?
“Cycle Times/24-Hour Ice Production/Refrigerant Pressure Charts” on page 195.

5. Discharge line temperature is greater than 150°F (66°C) [22" Models Only - 140°F (60°C)] at the end of the freeze cycle?
See "Discharge Line Temperature Analysis" on page 108.
6. Connect refrigeration manifold gauge set to the access valves on the front of the ice machine. Establish baseline by recording suction and discharge pressure and freeze & harvest cycle times. (Refer to "Cycle Times/24-Hour Ice Production/Refrigerant Pressure Charts" on page 195 for data collection detail.)
7. Freeze cycle Head Pressure is in the range indicated in the cycle time/24 hour ice production and operational pressure chart?
If the head pressure is low refer to "Freeze Cycle Discharge Pressure Low Checklist" on page 101.
8. Freeze cycle Suction Pressure normal?
Refer to "Analyzing Suction Pressure" on page 102 if suction pressure is high or low.
9. Harvest cycle suction and discharge pressures are lower than indicated in the cycle times/refrigerant pressures/24 hour ice production chart?
Replace Harvest Pressure Regulating solenoid.

WATER REGULATING VALVE

Water-Cooled Models Only

FUNCTION

The water regulating valve maintains the freeze cycle discharge pressure.

CHECK PROCEDURE

1. Determine if the head pressure is high or low (refer to cycle time/24 hour ice production and operational pressure chart for the model you are servicing).
2. Verify the condenser water meets specifications.
3. Adjust valve to increase or decrease discharge pressure.
4. Determine the temperature of the liquid line entering the receiver by feeling it. This line is normally warm; body temperature.
5. Using the information gathered, refer to the list for diagnosis.

Problem (Freeze Cycle)

Valve not maintaining discharge pressure.

- Valve incorrectly set, dirty or defective. Adjust, clean or replace valve.

Discharge pressure extremely high; Liquid line entering receiver feels hot.

- Water regulating valve incorrectly set or not opening.

Discharge pressure low, Liquid line entering receiver feels warm to hot.

- Ice machine low on charge. Verify “Replacing Pressure Controls Without Removing Refrigerant Charge” on page 192.

Refrigerant Recovery/Evacuation

DEFINITIONS

Recover

To remove refrigerant, in any condition, from a system and store it in an external container, without necessarily testing or processing it in any way.

Recycle

To clean refrigerant for re-use by oil separation and single or multiple passes through devices, such as replaceable core filter-driers, which reduce moisture, acidity and particulate matter. This term usually applies to procedures implemented at the field job site or at a local service shop.

Reclaim

To reprocess refrigerant to new product specifications (see below) by means which may include distillation. A chemical analysis of the refrigerant is required after processing to be sure that product specifications are met. This term usually implies the use of processes and procedures available only at a reprocessing or manufacturing facility.

Chemical analysis is the key requirement in this definition. Regardless of the purity levels reached by a reprocessing method, refrigerant is not considered “reclaimed” unless it has been chemically analyzed and meets ARI Standard 700 (latest edition).

New Product Specifications

This means ARI Standard 700 (latest edition). Chemical analysis is required to assure that this standard is met.

REFRIGERANT RE-USE POLICY

Manitowoc recognizes and supports the need for proper handling, re-use, and disposal of refrigerants. Manitowoc service procedures require recapturing refrigerants, not venting them to the atmosphere. It is not necessary, in or out of warranty, to reduce or compromise the quality and reliability of your customers' products to achieve this.

Notice

Manitowoc assumes no responsibility for use of contaminated refrigerant. Damage resulting from the use of contaminated, recovered, or recycled refrigerant is the sole responsibility of the servicing company.

Manitowoc approves the use of:

1. New Refrigerant
 - Must be of original nameplate type.
2. Reclaimed Refrigerant
 - Must be of original nameplate type.
 - Must meet ARI Standard 700 (latest edition) specifications.
3. Recovered or Recycled Refrigerant
 - Must be recovered or recycled in accordance with current local, state and federal laws.
 - Must be recovered from and re-used in the same Manitowoc product. Re-use of recovered or recycled refrigerant from other products is not approved.

4. Recovered refrigerant must come from a “contaminant-free” system. To decide whether the system is contaminant free, consider:
 - Type(s) of previous failure(s)
 - Whether the system was cleaned, evacuated and recharged properly following failure(s).
 - Whether the system has been contaminated by this failure.
 - Compressor motor burnouts and improper past service prevent refrigerant re-use.

Refer to “Determining Severity of Contamination” on page 185 to test for contamination.

5. “Substitute” or “Alternative” Refrigerant
 - Must use only Manitowoc-approved alternative refrigerants.
 - Must follow Manitowoc-published conversion procedures.

SELF-CONTAINED MODEL PROCEDURE

Do not purge refrigerant to the atmosphere. Capture refrigerant using recovery equipment. Follow the manufacturer's recommendations.

Notice

Manitowoc assumes no responsibility for the use of contaminated refrigerant. Damage resulting from the use of contaminated refrigerant is the sole responsibility of the servicing company.

Notice

Replace the liquid line drier after recovering the refrigerant and before evacuating and recharging. Use only a Manitowoc (OEM) liquid line filter-drier to prevent voiding the warranty.

Connections

Manifold gauge sets must utilize low loss fittings to comply with local rules and regulations.

Make these connections:

- Suction side of the compressor through the suction access valve.
- Discharge side of the compressor through the discharge access valve.
- Liquid side through the liquid line drier.

Self-Contained Recovery/Evacuation

1. Press the power button and cycle the ice machine off.
2. Install manifold gauge, scale and recovery unit or two-stage vacuum pump and open high, low and charging ports.
3. Perform recovery or evacuation:
 - A. Recovery: Operate the recovery unit as directed by the manufacturer's instructions.
 - B. Evacuation prior to recharging: Pull the system down to 500 microns. Then, allow the pump to run for an additional half hour. Turn off the pump and perform a standing vacuum leak check.
4. Follow the Charging Procedures.

Self-Contained Charging Procedures

Notice

The charge is critical on all Manitowoc ice machines. Use a scale to ensure the proper charge is installed.

1. Be sure the ice machine is off.
2. Isolate the vacuum pump valve, low side and high side access valves from the refrigeration system. The refrigerant charging access valve remains open.
3. Open the refrigerant cylinder and add the proper refrigerant charge (shown on nameplate) through the liquid line drier.
4. Let the system “settle” for 2 to 3 minutes.
5. Isolate the refrigerant cylinder/charging hose from the liquid line drier.
6. Press the power button.

NOTE: Manifold gauge set must be removed properly to ensure that no refrigerant contamination or loss occurs.

7. Make sure that all of the vapor in the charging hoses is drawn into the ice machine before disconnecting the charging hoses.
 - A. Run the ice machine in freeze cycle.
 - B. Remove the high side low loss fitting from the liquid line filter drier.
 - C. Open the high and low side valves on the manifold gauge set. Any refrigerant in the lines will be pulled into the low side of the system.
 - D. Allow the pressures to equalize while the ice machine is in the freeze cycle.
 - E. Remove the hoses from the ice machine and install the caps.

REMOTE CONDENSER MODEL PROCEDURE

Refrigerant Recovery/Evacuation

Do not purge refrigerant to the atmosphere. Capture refrigerant using recovery equipment. Follow the manufacturer's recommendations.

Notice

Manitowoc Ice assumes no responsibility for the use of contaminated refrigerant. Damage resulting from the use of contaminated refrigerant is the sole responsibility of the servicing company.

Notice

Replace the liquid line drier after recovering the refrigerant and before evacuating and recharging. Use only a Manitowoc (O.E.M.) liquid line filter drier to prevent voiding the warranty.

CONNECTIONS

Notice

Recovery/evacuation of a remote system requires connections at four points for complete system evacuation.

Make these connections:

- Suction side of the compressor through the suction service valve.
- Discharge side of the compressor through the discharge service valve.
- Receiver outlet service valve, which evacuates the area between the check valve in the liquid line and the liquid line solenoid.
- Access (Schrader) valve on the discharge line quick-connect fitting, located on the outside of the compressor/evaporator compartment. This connection evacuates the condenser. Without it, the magnetic check valves would close when the pressure drops during evacuation, preventing complete evacuation of the condenser.

NOTE: Manitowoc recommends using an access valve core removal and installation tool on the discharge line quick-connect fitting. This permits access valve core removal. This allows for faster evacuation and charging, without removing the manifold gauge hose.

REMOTE CONDENSER RECOVERY/EVACUATION

1. Press the power button to stop the ice machine.
2. Install manifold gauge set, scale and recovery unit or two-stage vacuum pump.
3. Open high and low side on the manifold gauge set.
4. Perform recovery or evacuation:
 - A. Recovery: Operate the recovery unit as directed by the manufacturer's instructions.
 - B. Evacuation prior to recharging: Pull the system down to 500 microns. Then, allow the pump to run for an additional hour. Turn off the pump and perform a standing vacuum leak check.

NOTE: Check for leaks with an electronic leak detector after charging the ice machine.

5. Follow the Charging Procedures.

Remote Charging Procedures

1. Close the vacuum pump valve and the low side manifold gauge valve.
2. Open the refrigerant cylinder and add the proper refrigerant charge (shown on nameplate) into the system high side (receiver outlet valve/liquid line drier and/or liquid line quick-connect fitting).
3. If the high side does not take the entire charge, close the high side on the manifold gauge set and start the ice machine. Add the remaining refrigerant through the low side (in vapor form) until the machine is fully charged.

NOTE: If an access valve core removal and installation tool is used on any of the Schrader valves, reinstall the cores before disconnecting the access tool and hose.

4. Remove the high side low loss fitting from the access valve.
5. Open the high and low side valves on the manifold gauge set. Any refrigerant in the lines will be pulled into the low side of the system.
6. Allow the pressures to equalize while the ice machine is in the freeze cycle.
7. Remove the low side hose from the access valve and install the caps.

System Contamination Clean-Up

General

This section describes the basic requirements for restoring contaminated systems to reliable service.

Notice

Manitowoc Ice assumes no responsibility for the use of contaminated refrigerant. Damage resulting from the use of contaminated refrigerant is the sole responsibility of the servicing company.

DETERMINING SEVERITY OF CONTAMINATION

System contamination is generally caused by either moisture or residue from compressor burnout entering the refrigeration system.

Inspection of the refrigerant usually provides the first indication of system contamination. Obvious moisture or an acid odor in the refrigerant indicates contamination.

If harmful levels of contamination are suspected, perform the following procedure.

1. Remove the refrigerant charge from the ice machine.
2. Remove the compressor from the system.
3. Check the odor and appearance of the oil.
4. Inspect open suction and discharge lines at the compressor for burnout deposits.
5. If no signs of contamination are present, perform an acid oil test to determine the type of cleanup required.

Contamination Cleanup Chart	
Symptoms/Findings	Required Cleanup Procedure
No symptoms or suspicion of contamination	Normal evacuation/recharging procedure
Moisture/Air Contamination symptoms Refrigeration system open to atmosphere for longer than 15 minutes Refrigeration test kit and/or acid oil test shows contamination Leak in water cooled condenser No burnout deposits in open compressor lines	Mild contamination cleanup procedure
Mild Compressor Burnout symptoms Oil appears clean but smells acrid Refrigeration test kit or acid oil test shows harmful acid content No burnout deposits in open compressor lines	Mild contamination cleanup procedure
Severe Compressor Burnout symptoms Oil is discolored, acidic, and smells acrid Burnout deposits found in the compressor, lines, and other components	Severe contamination cleanup procedure

CLEANUP PROCEDURE

Mild System Contamination

1. Replace any failed components.
2. If the compressor is good, change the oil.
3. Replace the liquid line drier.

NOTE: If the contamination is from moisture, use heat lamps during evacuation. Position them at the compressor, condenser and evaporator prior to evacuation. Do not position heat lamps too close to plastic components, or they may melt or warp.

Important

Dry nitrogen is required for this procedure to prevent refrigerant release.

4. Follow the normal evacuation procedure, except replace the evacuation step with the following:
 - A. Pull vacuum to 1000 microns. Break the vacuum with dry nitrogen and sweep the system. Pressurize to a minimum of 5 psig (35 kPa, .35 bar).
 - B. Pull vacuum to 500 microns. Break the vacuum with dry nitrogen and sweep the system. Pressurize to a minimum of 5 psig (35 kPa, .35 bar).
 - C. Change the vacuum pump oil.
 - D. Pull vacuum to 500 microns. Run the vacuum pump for 1/2 hour on self-contained models, 1 hour on remotes.
 - E. You may perform a standing vacuum test to make a preliminary leak check. You should use an electronic leak detector after system charging to be sure there are no leaks.
5. Charge the system with the proper refrigerant to the nameplate charge.
6. Operate the ice machine.

Severe System Contamination

1. Remove the refrigerant charge.
2. Remove the compressor and inspect the refrigeration lines. If burnout deposits are found, install a new harvest valve, replace the manifold strainer, TXV and harvest pressure regulating valve.
3. Wipe away any burnout deposits from suction and discharge lines at compressor.
4. Sweep through the open system with dry nitrogen.

Important

Refrigerant sweeps are not recommended, as they release CFCs into the atmosphere.

5. Install a new compressor and new start components.
6. Install a suction line filter-drier with acid and moisture removal capability. Place the filter drier as close to the compressor as possible.
7. Install an access valve at the inlet of the suction line drier.
8. Install a new liquid line drier.

Important

Dry nitrogen is required for this procedure. This will prevent CFC release.

9. Follow the normal evacuation procedure, except replace the evacuation step with the following:
 - A. Pull vacuum to 1000 microns. Break the vacuum with dry nitrogen and sweep the system. Pressurize to a minimum of 5 psig (35 kPa, .35 bar).
 - B. Change the vacuum pump oil.
 - C. Pull vacuum to 500 microns. Break the vacuum with dry nitrogen and sweep the system. Pressurize to a minimum of 5 psig (35 kPa, .35 bar).
 - D. Change the vacuum pump oil.
 - E. Pull vacuum to 500 microns. Run the vacuum pump for 1/2 hour on self-contained models, 1 hour on remotes.

NOTE: You may perform a standing vacuum test to make a preliminary leak check. You should use an electronic leak detector after system charging to be sure there are no leaks.

10. Charge the system with the proper refrigerant to the nameplate charge.
11. Operate the ice machine for one hour. Then, check the pressure drop across the suction line filter-drier.
 - A. If the pressure drop is less than 1 psig (7 kPa, .07 bar), the filter-drier should be adequate for complete cleanup.
 - B. If the pressure drop exceeds 1 psig (7 kPa, .07 bar), change the suction line filter-drier and the liquid line drier. Repeat until the pressure drop is acceptable.
12. Operate the ice machine for 48-72 hours. Then remove the suction line drier and change the liquid line drier.
13. Follow normal evacuation procedures.

LIQUID LINE FILTER-DRIERS

The filter-driers used on Manitowoc ice machines are manufactured to Manitowoc specifications and have an access fitting for charging with refrigerant. A Manitowoc drier also has dirt-retaining filtration, with fiberglass filters on both the inlet and outlet ends. This is very important because ice machines have a back-flushing action that takes place during every Harvest cycle.

A Manitowoc filter-drier has high moisture and acid removal capability.

The size of the filter-drier is important. The refrigerant charge is critical. Using an improperly sized filter-drier will cause the ice machine to be improperly charged with refrigerant.

Important

Driers are covered as a warranty part. The drier must be replaced any time the system is opened for repairs.

REPLACING PRESSURE CONTROLS WITHOUT REMOVING REFRIGERANT CHARGE

This procedure reduces repair time and cost. Use it when any of the following components require replacement, and the refrigeration system is operational and leak-free.

- Fan cycle control (air cooled only)
 - Water regulating valve (water cooled only)
 - High pressure cut-out control
 - High side service valve
1. Disconnect power to the ice machine.
 2. Follow all manufacturer's instructions supplied with the pinch-off tool. Position the pinch-off tool around the tubing as far from the pressure control as feasible. Clamp down on the tubing until the pinch-off is complete.

Warning

Do not unsolder a defective component. Cut it out of the system. Do not remove the pinch-off tool until the new component is securely in place.

Cut the tubing of the defective component with a small tubing cutter.

3. Solder the replacement component in place. Allow the solder joint to cool.
4. Remove the pinch-off tool.
5. Re-round the tubing. The pressure control will operate normally once the tubing is re-rounded. Tubing may not re-round 100%.

TOTAL SYSTEM REFRIGERANT CHARGE

This information is for reference only. Refer to the ice machine serial number tag to verify the system charge. Serial plate information overrides information listed on these pages.

Self-Contained Air & Water Cooled

Model	Refrigerant Type	Air Cooled	Water Cooled
IF0300	R404A	15 oz	12 oz
IT0420	R410A	18 oz.	18 oz.
IT0450	R410A	18 oz.	15 oz.
IT0500	R410A	19 oz.	24 oz.
IF0600	R404A	32 oz	26 oz
IT0620	R410A	19 oz.	14 oz.
IF0900	R404A	34 oz	26 oz
IT1200	R410A	46 oz.	40 oz.
IT1500	R410A	42 oz.	38 oz.
IT1900	R410A	44 oz.	38 oz.

Remote Condenser

Model	Refrigerant Type	Remote	Additional Refrigerant for Line Sets 51'-100'	Maximum System Charge
IT0500	R410A	6 lb	1.5 lb.	7.5 lb
IF0600	R404A	6.5 lb	2 lb	8.5 lb
IF0900	R404A	6.5 lb	2 lb	8.5 lb
IT1200	R410A	7.5 lb	2 lb	9.5 lb
IT1500	R410A	7 lb	2 lb	9 lb
IT1900	R410A	8 lb	2 lb	10 lb

THIS PAGE INTENTIONALLY LEFT BLANK

Charts

Cycle Times/24-Hour Ice Production/ Refrigerant Pressure Charts

These charts are used as guidelines to verify correct ice machine operation.

Accurate collection of data is essential to obtain the correct diagnosis.

- Production and cycle times are for dice cube - Half dice cube cycle times can be 2 - 3 minutes faster, depending on model and ambient temperature.
- Regular cube production derate is 7%.
- Ice production checks that are within 10% of the chart are considered normal. This is due to variances in water and air temperature. Actual temperatures will seldom match the chart exactly.
- Refer to “Symptom #2 - Freeze Cycle Refrigeration System Operational Analysis Tables” on page 82 for the list of data that must be collected for refrigeration diagnostics.
- Zero out manifold gauge set before obtaining pressure readings to avoid mis-diagnosis.
- Discharge and suction pressure are highest at the beginning of the cycle. Suction pressure will drop throughout the cycle. Verify the pressures are within the range indicated.
- Record beginning of freeze cycle suction pressure one minute after water pump energizes.
- 50 Hz dice and half dice production derate is 12%.
- 50 Hz regular cube total production derate is 14%.

IF0300 SERIES

IF0300A

Self-Contained Air-Cooled Model

Characteristics vary depending on operating conditions.

CYCLE TIMES

Freeze Time + Harvest Time = Total Cycle Time

Air Temp. Entering Condenser °F/°C	Freeze Time			Harvest Time ¹
	Water Temperature °F/°C			
	50/10	70/21	90/32	
70/21	9.6-11.5	10.8-12.9	12.3-14.6	1-2.5
80/27	10.6-12.6	12.3-14.6	13.5-16.0	
90/32	11.8-14.0	13.9-16.4	15.0-17.7	
100/38	13.2-15.7	14.6-17.3	16.2-19.2	
110/43	15.0-17.7	15.8-18.7	17.7-20.9	

¹ Times in minutes

24 HOUR ICE PRODUCTION

Air Temp. Entering Condenser °F/°C	Water Temperature °F/°C ¹		
	50/10	70/21	90/32
70/21	310	280	250
80/27	285	250	230
90/32	260	225	210
100/38	235	215	195
110/43	210	200	180

¹ Based on average ice slab weight of 2.40 - 2.80 lb.

OPERATING PRESSURES

Air Temp Entering Condenser °F/°C	Freeze Cycle		Harvest Cycle	
	Discharge Pressure PSIG	Suction Pressure PSIG ¹	Discharge Pressure PSIG	Suction Pressure PSIG
	50/10	195-245	50-20	135-160
70/21	195-260	50-20	135-165	80-110
80/27	220-290	60-24	150-170	90-120
90/32	240-320	60-25	170-195	115-135
100/38	285-370	70-28	200-220	130-155
110/43	330-415	78-32	230-250	150-175

¹ Suction pressure drops gradually throughout the freeze cycle

IF0300W

Self-Contained Water-Cooled Model

Characteristics vary depending on operating conditions.

CYCLE TIMES

Freeze Time + Harvest Time = Total Cycle Time

Air Temp. Around Ice Machine °F/°C	Freeze Time			Harvest Time ¹
	Water Temperature °F/°C			
	50/10	70/21	90/32	
70/21	10.0-11.9	11.1-13.2	12.3-14.6	1-2.5
80/27	10.2-12.2	11.3-13.4	12.3-14.6	
90/32	10.4-12.4	11.8-14.0	12.6-15.0	
100/38	10.6-12.6	11.8-14.0	12.6-15.7	
110/43	10.8-12.9	11.8-14.0	12.9-15.3	

1 Times in minutes

24 HOUR ICE PRODUCTION

Air Temp. Around Ice Machine °F/°C	Water Temperature °F/°C ¹		
	50/10	70/21	90/32
70/21	300	275	250
80/27	295	270	250
90/32	290	260	245
100/38	285	260	245
110/43	280	260	240

1 Based on average ice slab weight of 2.40 - 2.80 lb.

OPERATING PRESSURES

Air Temp Around Ice Machine °F/°C	Freeze Cycle		Harvest Cycle	
	Discharge Pressure PSIG	Suction Pressure PSIG ¹	Discharge Pressure PSIG	Suction Pressure PSIG
50/10	225-235	50-25	130-170	75-100
70/21	225-235	50-28	130-170	85-100
80/27	225-245	65-29	130-180	85-110
90/32	230-250	65-30	135-180	85-115
100/38	230-260	70-31	145-190	90-120
110/43	235-260	70-31	150-190	90-120

1 Suction pressure drops gradually throughout the freeze cycle

2 Water regulating valve set to maintain 230 psig

3 Condenser Water Usage = 193 gal/100 lb ice @ 90°/70°F

IT0420 SERIES

IT0420A

Self-Contained Air-Cooled Model

Characteristics vary depending on operating conditions.

CYCLE TIMES

Freeze Time + Harvest Time = Total Cycle Time

Air Temp. Entering Condenser °F/°C	Freeze Time			Harvest Time ¹
	Water Temperature °F/°C			
	50/10	70/21	90/32	
70/21	9.9-10.4	10.4-12.2	13.1-15.3	1-2.5
80/27	9.9-11.6	11.7-13.7	13.6-15.8	
90/32	10.7-12.5	11.7-13.7	13.8-16.1	
100/38	12.1-14.1	13.1-15.3	14.3-16.6	
110/43	12.9-15.0	14.0-16.3	14.8-17.2	

1 Times in minutes

24 HOUR ICE PRODUCTION

Air Temp. Entering Condenser °F/°C	Water Temperature °F/°C ¹		
	50/10	70/21	90/32
70/21	470	410	335
80/27	430	370	325
90/32	400	375	320
100/38	360	335	310
110/43	340	315	300

1 Based on average ice slab weight of 3.40 - 3.90 lb.

OPERATING PRESSURES

Air Temp Entering Condenser °F/°C	Freeze Cycle		Harvest Cycle	
	Discharge Pressure PSIG	Suction Pressure PSIG ¹	Discharge Pressure PSIG	Suction Pressure PSIG
50/10	270-340	60-30	145-170	115-135
70/21	280-340	70-36	160-190	120-140
80/27	335-365	70-38	180-205	120-160
90/32	350-410	80-40	185-210	180-210
100/38	460-500	80-45	265-290	180-210
110/43	460-520	80-45	270-290	180-220

1 Suction pressure drops gradually throughout the freeze cycle

IT0420W

Self-Contained Water-Cooled Model

Characteristics vary depending on operating conditions.

CYCLE TIMES

Freeze Time + Harvest Time = Total Cycle Time

Air Temp. Around Ice Machine °F/°C	Freeze Time			Harvest Time ¹
	Water Temperature °F/°C			
	50/10	70/21	90/32	
70/21	9.3-10.8	10.2-11.9	11.6-13.5	1-2.5
80/27	9.5-11.1	10.4-12.2	11.7-13.7	
90/32	9.8-11.4	10.7-12.5	11.9-13.9	
100/38	10.0-11.7	11.1-12.9	12.5-14.5	
110/43	10.3-12.0	11.4-13.3	12.3-14.3	

1 Times in minutes

24 HOUR ICE PRODUCTION

Air Temp. Around Ice Machine °F/°C	Water Temperature °F/°C ¹		
	50/10	70/21	90/32
70/21	455	420	375
80/27	445	410	370
90/32	435	400	365
100/38	425	390	350
110/43	415	380	355

1 Based on average ice slab weight of 3.40 - 3.90 lb.

OPERATING PRESSURES

Air Temp Around Ice Machine °F/°C	Freeze Cycle		Harvest Cycle	
	Discharge Pressure PSIG	Suction Pressure PSIG ¹	Discharge Pressure PSIG	Suction Pressure PSIG
50/10	330	70-38	155-180	120-145
70/21	330-340	70-39	175-195	130-150
80/27	330-345	70-40	175-200	130-150
90/32	330-345	75-40	175-200	130-150
100/38	330-350	75-44	175-200	130-150
110/43	330-350	75-45	175-200	135-150

1 Suction pressure drops gradually throughout the freeze cycle

2 Water regulating valve set to maintain 330 psig

IT0450 SERIES

IT0450A

Self-Contained Air-Cooled Model

Characteristics vary depending on operating conditions.

CYCLE TIMES

Freeze Time + Harvest Time = Total Cycle Time

Air Temp. Entering Condenser °F/°C	Freeze Time			Harvest Time ¹
	Water Temperature °F/°C			
	50/10	70/21	90/32	
70/21	8.9-10.4	9.9-11.6	10.9-12.7	1-2.5
80/27	9.9-11.6	10.9-12.7	11.9-13.9	
90/32	10.7-12.5	12.1-14.1	13.1-15.3	
100/38	11.7-13.7	13.3-15.5	14.6-16.9	
110/43	13.1-15.3	14.3-16.6	15.1-17.5	

1 Times in minutes

24 HOUR ICE PRODUCTION

Air Temp. Entering Condenser °F/°C	Water Temperature °F/°C ¹		
	50/10	70/21	90/32
70/21	470	430	395
80/27	430	395	365
90/32	400	360	335
100/38	370	330	305
110/43	335	310	295

1 Based on average ice slab weight of 3.40 - 3.90 lb.

OPERATING PRESSURES

Air Temp Entering Condenser °F/°C	Freeze Cycle		Harvest Cycle	
	Discharge Pressure PSIG	Suction Pressure PSIG ¹	Discharge Pressure PSIG	Suction Pressure PSIG
50/10	260-335	60-28	145-160	105-125
70/21	260-340	70-32	160-180	120-145
80/27	280-360	75-38	170-190	130-150
90/32	360-400	80-40	175-200	135-160
100/38	440-500	85-42	250-270	185-210
110/43	450-520	85-43	250-280	185-215

1 Suction pressure drops gradually throughout the freeze cycle

IT0450W

Self-Contained Water-Cooled Model

Characteristics vary depending on operating conditions.

CYCLE TIMES

Freeze Time + Harvest Time = Total Cycle Time

Air Temp. Around Ice Machine °F/°C	Freeze Time			Harvest Time ¹
	Water Temperature °F/°C			
	50/10	70/21	90/32	
70/21	9.9-11.6	11.1-12.9	12.1-14.1	1-2.5
80/27	10.2-11.9	11.6-13.5	12.5-14.5	
90/32	10.3-12.0	12.1-14.1	12.9-15.0	
100/38	10.4-12.2	12.5-14.5	13.3-15.5	
110/43	10.7-12.5	12.9-15.0	14.3-16.6	

1 Times in minutes

24 HOUR ICE PRODUCTION

Air Temp. Around Ice Machine °F/°C	Water Temperature °F/°C ¹		
	50/10	70/21	90/32
70/21	430	390	360
80/27	420	375	350
90/32	415	360	340
100/38	410	350	330
110/43	400	340	310

1 Based on average ice slab weight of 3.40 - 3.90 lb.

OPERATING PRESSURES

Air Temp Around Ice Machine °F/°C	Freeze Cycle		Harvest Cycle	
	Discharge Pressure PSIG	Suction Pressure PSIG ¹	Discharge Pressure PSIG	Suction Pressure PSIG
50/10	330-335	70-35	155-180	125-150
70/21	330-335	70-35	165-190	125-155
80/27	330-335	70-36	165-190	125-155
90/32	330-335	75-38	170-190	130-155
100/38	330-335	75-39	170-195	130-155
110/43	330-350	85-42	170-200	130-165

1 Suction pressure drops gradually throughout the freeze cycle

2 Water regulating valve set to maintain 330 psig

IT0500 SERIES

IT0500A

Self-Contained Air-Cooled Model

Characteristics vary depending on operating conditions.

CYCLE TIMES

Freeze Time + Harvest Time = Total Cycle Time

Air Temp. Entering Condenser °F/°C	Freeze Time			Harvest Time ¹
	Water Temperature °F/°C			
	50/10	70/21	90/32	
70/21	11.2-12.9	13.1-15.0	14.5-16.5	1-2.5
80/27	12.3-14.1	14.5-16.5	14.9-17.0	
90/32	13.2-15.1	15.1-17.2	16.9-19.3	
100/38	14.7-16.8	16.9-19.3	18.6-21.2	
110/43	15.5-17.7	18.0-20.5	20.2-23.1	

1 Times in minutes

24 HOUR ICE PRODUCTION

Air Temp. Entering Condenser °F/°C	Water Temperature °F/°C ¹²		
	50/10	70/21	90/32
70/21	520	455	415
80/27	480	415	405
90/32	450	400	360
100/38	410	360	330
110/43	390	340	305

1 Based on average ice slab weight of 4.60 - 5.20 lb.

2 230/50/1 is approximately 12% lower than 230/60/1

OPERATING PRESSURES

Air Temp Entering Condenser °F/°C	Freeze Cycle		Harvest Cycle	
	Discharge Pressure PSIG	Suction Pressure PSIG ¹	Discharge Pressure PSIG	Suction Pressure PSIG
50/10	260-340	70-38	130-150	110-120
70/21	265-350	75-38	140-165	110-135
80/27	310-375	80-39	160-190	120-155
90/32	345-400	85-40	175-200	140-165
100/38	410-500	90-48	240-260	150-195
110/43	455-510	95-48	245-260	170-200

1 Suction pressure drops gradually throughout the freeze cycle

IT0500W

Self-Contained Water-Cooled Model

Characteristics vary depending on operating conditions.

CYCLE TIMES

Freeze Time + Harvest Time = Total Cycle Time

Air Temp. Around Ice Machine °F/°C	Freeze Time			Harvest Time ¹
	Water Temperature °F/°C			
	50/10	70/21	90/32	
70/21	11.7-13.5	13.9-15.9	15.9-18.2	1-2.5
80/27	12.3-14.1	14.5-16.5	16.4-18.7	
90/32	12.4-14.3	15.1-17.2	16.9-19.3	
100/38	12.6-14.4	15.5-17.7	17.4-19.9	
110/43	12.9-14.8	15.9-18.2	18.0-20.5	

1 Times in minutes

24 HOUR ICE PRODUCTION

Air Temp. Around Ice Machine °F/°C	Water Temperature °F/°C ¹		
	50/10	70/21	90/32
70/21	500	430	380
80/27	480	415	370
90/32	475	400	360
100/38	470	390	350
110/43	460	380	340

1 Based on average ice slab weight of 4.60 - 5.20 lb.

OPERATING PRESSURES

Air Temp Around Ice Machine °F/°C	Freeze Cycle		Harvest Cycle	
	Discharge Pressure PSIG	Suction Pressure PSIG ¹	Discharge Pressure PSIG	Suction Pressure PSIG
50/10	330	75-38	165-175	135-150
70/21	330-335	75-40	165-180	135-155
80/27	330-350	80-41	180-190	140-160
90/32	330-335	80-42	180-190	145-160
100/38	330-335	80-43	180-190	145-160
110/43	330-350	85-43	185-210	150-175

1 Suction pressure drops gradually throughout the freeze cycle

2 Water regulating valve set to maintain 230 psig

IT0500N

Remote Air-Cooled Condenser Model

Characteristics vary depending on operating conditions.

CYCLE TIMES

Freeze Time + Harvest Time = Total Cycle Time

Air Temp. Entering Condenser °F/°C	Freeze Time			Harvest Time ¹
	Water Temperature °F/°C			
	50/10	70/21	90/32	
-20/-29 to 70/21	11.5-13.2	12.2-13.9	13.6-15.5	1-2.5
80/27	12.2-13.9	12.6-14.4	14.1-16.1	
90/32	12.6-14.4	13.2-15.1	14.7-16.8	
100/38	13.1-15.0	14.1-16.1	15.3-17.5	
110/43	13.6-15.5	14.5-16.5	15.9-18.2	

1 Times in minutes

24 HOUR ICE PRODUCTION

Air Temp. Entering Condenser °F/°C	Water Temperature °F/°C ¹		
	50/10	70/21	90/32
-20/-29 to 70/21	510	485	440
80/27	485	470	425
90/32	470	450	410
100/38	455	425	395
110/43	440	415	380

1 Based on average ice slab weight of 4.60 - 5.20 lb.

OPERATING PRESSURES

Air Temp Entering Condenser °F/°C	Freeze Cycle		Harvest Cycle	
	Discharge Pressure PSIG	Suction Pressure PSIG ¹	Discharge Pressure PSIG	Suction Pressure PSIG
-20 to 50 -29 to 10	270-280	60-38	195-205	130-145
70/21	300-315	70-42	215-230	145-160
80/27	300-320	75-42	220-240	145-160
90/32	315-360	75-44	220-240	145-160
100/38	395-460	80-51	240-260	155-175
110/43	380-470	90-52	240-260	155-175

1 Suction pressure drops gradually throughout the freeze cycle

IF0600 SERIES

IF0600A

Self-Contained Air-Cooled Model

Characteristics vary depending on operating conditions.

CYCLE TIMES

Freeze Time + Harvest Time = Total Cycle Time

Air Temp. Entering Condenser °F/°C	Freeze Time			Harvest Time ¹
	Water Temperature °F/°C			
	50/10	70/21	90/32	
70/21	7.6-9.0	9.5-11.2	10.2-12.0	1-2.5
80/27	8.8-10.4	9.9-11.7	10.5-12.3	
90/32	9.7-11.4	11.0-12.9	11.4-13.4	
100/38	11.1-13.1	12.3-14.4	12.8-15.0	

1 Times in minutes

24 HOUR ICE PRODUCTION

Air Temp. Entering Condenser °F/°C	Water Temperature °F/°C ¹		
	50/10	70/21	90/32
70/21	650	540	505
80/27	575	520	495
90/32	530	475	460
100/38	470	430	415

1 Based on average ice slab weight of 4.12 - 4.75 lb.

OPERATING PRESSURES

Air Temp Entering Condenser °F/°C	Freeze Cycle		Harvest Cycle	
	Discharge Pressure PSIG	Suction Pressure PSIG ¹	Discharge Pressure PSIG	Suction Pressure PSIG
50/10	220-255	45-27	140-160	60-80
70/21	220-270	45-28	145-170	70-90
80/27	230-300	50-30	165-185	75-95
90/32	265-345	54-32	180-215	80-105
100/38	300-395	60-35	210-245	85-120
110/43	340-430	65-39	240-280	100-140

1 Suction pressure drops gradually throughout the freeze cycle

IF0600W

Self-Contained Water-Cooled Model

Characteristics vary depending on operating conditions.

CYCLE TIMES

Freeze Time + Harvest Time = Total Cycle Time

Air Temp. Around Ice Machine °F/°C	Freeze Time			Harvest Time ¹
	Water Temperature °F/°C			
	50/10	70/21	90/32	
70/21	7.6-9.0	9.0-10.6	9.7-11.4	1-2.5
80/27	8.8-10.4	9.1-10.7	9.9-11.7	
90/32	9.6-10.6	9.1-10.7	9.9-11.7	
100/38	9.1-10.7	9.5-11.2	10.2-12.0	

1 Times in minutes

24 HOUR ICE PRODUCTION

Air Temp. Around Ice Machine °F/°C	Water Temperature °F/°C ¹		
	50/10	70/21	90/32
70/21	650	565	530
80/27	575	560	520
90/32	565	560	520
100/38	560	540	505

1 Based on average ice slab weight of 4.12 - 4.75 lb.

OPERATING PRESSURES

Air Temp Around Ice Machine °F/°C	Freeze Cycle		Harvest Cycle	
	Discharge Pressure PSIG	Suction Pressure PSIG ¹	Discharge Pressure PSIG	Suction Pressure PSIG
50/10	240-250	36-26	140-190	65-95
70/21	240-250	36-26	140-190	65-95
80/27	240-250	40-28	150-195	70-100
90/32	245-255	40-29	160-200	70-100
100/38	245-260	40-30	170-205	75-105
110/43	245-265	40-30	180-210	80-110

1 Suction pressure drops gradually throughout the freeze cycle

2 Water regulating valve set to maintain 240 psig

3 Condenser Water Usage = 157 gal/100 lb ice @ 90°/70°F

IF0600N

Remote Air-Cooled Condenser Model

Characteristics vary depending on operating conditions.

CYCLE TIMES

Freeze Time + Harvest Time = Total Cycle Time

Air Temp. Entering Condenser °F/°C	Freeze Time			Harvest Time ¹
	Water Temperature °F/°C			
	50/10	70/21	90/32	
-20/-29 to 70/21	7.9-9.4	9.9-11.7	10.5-12.3	1-2.5
80/27	9.0-10.6	9.9-11.7	10.7-12.6	
90/32	9.1-10.7	9.9-11.7	10.7-12.6	
100/38	9.9-11.7	10.9-12.8	11.7-13.7	
110/43	10.9-12.8	12.0-14.0	12.8-15.0	

1 Times in minutes

24 HOUR ICE PRODUCTION

Air Temp. Entering Condenser °F/°C	Water Temperature °F/°C ¹		
	50/10	70/21	90/32
-20/-29 to 70/21	630	520	495
80/27	565	520	485
90/32	560	520	485
100/38	520	480	450
110/43	480	440	415

1 Based on average ice slab weight of 4.12 - 4.75 lb.

2 Ratings with JC0895 condenser dice cubes

OPERATING PRESSURES

Air Temp Entering Condenser °F/°C	Freeze Cycle		Harvest Cycle	
	Discharge Pressure PSIG	Suction Pressure PSIG ¹	Discharge Pressure PSIG	Suction Pressure PSIG
-20/-29 to 50/10	210-240	40-29	130-190	62-80
70/21	225-250	50-30	130-200	75-95
80/27	245-275	52-31	130-200	75-100
90/32	245-285	52-32	135-200	80-100
100/38	260-315	55-32	140-200	80-100
110/43	290-365	60-34	170-200	85-100

1 Suction pressure drops gradually throughout the freeze cycle

IT0620 SERIES

IT0620A

Self-Contained Air-Cooled Model

Characteristics vary depending on operating conditions.

CYCLE TIMES

Freeze Time + Harvest Time = Total Cycle Time

Air Temp. Entering Condenser °F/°C	Freeze Time			Harvest Time ¹
	Water Temperature °F/°C			
	50/10	70/21	90/32	
70/21	10.3-11.9	11.2-12.9	11.6-13.3	1-2.5
80/27	11.2-12.9	12.3-14.1	12.7-14.6	
90/32	12.0-13.8	13.2-15.1	13.7-15.7	
100/38	13.2-15.1	14.7-16.8	15.3-17.5	
110/43	13.9-15.9	15.5-17.7	16.2-18.5	

1 Times in minutes

24 HOUR ICE PRODUCTION

Air Temp. Entering Condenser °F/°C	Water Temperature °F/°C ¹		
	50/10	70/21	90/32
70/21	560	520	505
80/27	520	480	465
90/32	490	450	435
100/38	450	410	395
110/43	430	390	375

1 Based on average ice slab weight of 4.60 - 5.20 lb.

OPERATING PRESSURES

Air Temp Entering Condenser °F/°C	Freeze Cycle		Harvest Cycle	
	Discharge Pressure PSIG	Suction Pressure PSIG ¹	Discharge Pressure PSIG	Suction Pressure PSIG
50/10	255-335	60-30	155-170	105-130
70/21	270-340	70-30	170-200	115-135
80/27	270-340	75-35	170-200	115-135
90/32	350-405	75-38	205-240	140-155
100/38	450-520	90-40	290-340	160-235
110/43	450-540	90-42	290-340	160-235

1 Suction pressure drops gradually throughout the freeze cycle

IT0620W

Self-Contained Water-Cooled Model

Characteristics vary depending on operating conditions.

CYCLE TIMES

Freeze Time + Harvest Time = Total Cycle Time

Air Temp. Around Ice Machine °F/°C	Freeze Time			Harvest Time ¹
	Water Temperature °F/°C			
	50/10	70/21	90/32	
70/21	11.0-12.6	12.3-14.1	13.6-15.5	1-2.5
80/27	10.8-12.4	12.7-14.6	14.1-16.1	
90/32	10.9-12.5	13.2-15.1	14.7-16.8	
100/38	11.0-12.6	13.6-15.5	15.1-17.2	
110/43	11.5-13.2	13.9-15.9	15.5-17.7	

1 Times in minutes

24 HOUR ICE PRODUCTION

Air Temp. Around Ice Machine °F/°C	Water Temperature °F/°C ¹		
	50/10	70/21	90/32
70/21	530	480	440
80/27	540	465	425
90/32	535	450	410
100/38	530	440	400
110/43	510	430	390

1 Based on average ice slab weight of 4.60 - 5.20 lb.

OPERATING PRESSURES

Air Temp Around Ice Machine °F/°C	Freeze Cycle		Harvest Cycle	
	Discharge Pressure PSIG	Suction Pressure PSIG ¹	Discharge Pressure PSIG	Suction Pressure PSIG
50/10	330	60-32	155-180	115-140
70/21	330-335	60-34	160-200	125-145
80/27	330-340	60-34	160-200	125-145
90/32	330-340	65-35	170-200	125-150
100/38	330-345	75-41	170-200	125-150
110/43	330-355	80-42	170-200	125-150

1 Suction pressure drops gradually throughout the freeze cycle

2 Water regulating valve set to maintain 330 psig

IF0900 SERIES

IF0900A

Self-Contained Air-Cooled Model

Characteristics vary depending on operating conditions.

CYCLE TIMES

Freeze Time + Harvest Time = Total Cycle Time

Air Temp. Entering Condenser °F/°C	Freeze Time			Harvest Time ¹
	Water Temperature °F/°C			
	50/10	70/21	90/32	
70/21	8.7-10.3	10.2-12.1	10.8-12.8	1-2.5
80/27	9.7-11.5	10.5-12.4	11.1-13.1	
90/32	10.5-12.4	11.9-14.1	12.2-14.5	
100/38	11.3-13.4	12.3-14.6	12.7-15.0	

¹ Times in minutes

24 HOUR ICE PRODUCTION

Air Temp. Entering Condenser °F/°C	Water Temperature °F/°C ¹		
	50/10	70/21	90/32
70/21	875	765	725
80/27	800	745	710
90/32	745	665	650
100/38	695	645	630

¹ Based on average ice slab weight of 6.2 - 7.2 lb.

OPERATING PRESSURES

Air Temp Entering Condenser °F/°C	Freeze Cycle		Harvest Cycle	
	Discharge Pressure PSIG	Suction Pressure PSIG ¹	Discharge Pressure PSIG	Suction Pressure PSIG
50/10	220-255	45-27	125-140	60-80
70/21	220-270	45-30	150-160	75-90
80/27	230-300	50-30	150-160	80-100
90/32	260-315	55-32	160-175	90-115
100/38	300-395	74-34	180-220	130-160
110/43	320-400	78-34	200-230	130-160

¹ Suction pressure drops gradually throughout the freeze cycle

IF0900W

Self-Contained Water-Cooled Model

Characteristics vary depending on operating conditions.

CYCLE TIMES

Freeze Time + Harvest Time = Total Cycle Time

Air Temp. Around Ice Machine °F/°C	Freeze Time			Harvest Time ¹
	Water Temperature °F/°C			
	50/10	70/21	90/32	
70/21	9.1-10.8	10.3-12.2	10.9-12.9	1-2.5
80/27	10.2-12.1	10.4-12.3	11.1-13.1	
90/32	10.4-12.3	11.3-13.3	11.4-13.5	
100/38	11.6-12.5	11.6-13.7	11.9-14.1	
110/43	11.3-13.3	12.2-14.5	13.0-15.4	

1 Times in minutes

24 HOUR ICE PRODUCTION

Air Temp. Around Ice Machine °F/°C	Water Temperature °F/°C ¹		
	50/10	70/21	90/32
70/21	840	755	720
80/27	765	750	710
90/32	750	700	690
100/38	740	680	665
110/43	700	650	615

1 Based on average ice slab weight of 6.2 - 7.2 lb.

OPERATING PRESSURES

Air Temp Around Ice Machine °F/°C	Freeze Cycle		Harvest Cycle	
	Discharge Pressure PSIG	Suction Pressure PSIG ¹	Discharge Pressure PSIG	Suction Pressure PSIG
50/10	225-235	45-28	130-160	75-90
70/21	225-235	45-30	130-160	75-90
80/27	230-245	50-30	130-160	75-90
90/32	225-235	55-31	130-160	75-90
100/38	235-250	55-32	135-160	75-95
110/43	235-265	60-32	140-160	75-95

1 Suction pressure drops gradually throughout the freeze cycle

2 Water regulating valve set to maintain 230 psig

3 Condenser Water Usage = 141 gal/100 lb ice @ 90°/70°F

IF0900N

Remote Air-Cooled Condenser Model

Characteristics vary depending on operating conditions.

CYCLE TIMES

Freeze Time + Harvest Time = Total Cycle Time

Air Temp. Entering Condenser °F/°C	Freeze Time			Harvest Time ¹
	Water Temperature °F/°C			
	50/10	70/21	90/32	
-20/-29 to 70/21	9.4-11.1	10.2-12.1	11.0-12.9	0.75-2.0
80/27	9.8-11.6	10.4-12.3	11.3-13.3	
90/32	10.4-12.3	10.7-12.7	11.7-13.9	
100/38	10.9-12.9	11.6-13.7	12.2-14.5	
110/43	11.5-13.6	12.2-14.5	13.0-15.4	

1 Times in minutes

24 HOUR ICE PRODUCTION

Air Temp. Entering Condenser °F/°C	Water Temperature °F/°C ¹		
	50/10	70/21	90/32
-20/-29 to 70/21	820	765	720
80/27	790	750	700
90/32	750	730	675
100/38	720	680	650
110/43	685	650	615

1 Based on average ice slab weight of 6.2 - 7.2 lb.

OPERATING PRESSURES

Air Temp Entering Condenser °F/°C	Freeze Cycle		Harvest Cycle	
	Discharge Pressure PSIG	Suction Pressure PSIG ¹	Discharge Pressure PSIG	Suction Pressure PSIG
50/10	240-260	60-30	120-145	70-90
70/21	245-260	60-30	120-145	75-90
80/27	245-270	60-31	120-145	75-90
90/32	250-285	60-32	125-145	75-95
100/38	285-350	65-34	135-165	75-100
110/43	310-375	70-36	145-170	75-100

1 Suction pressure drops gradually throughout the freeze cycle

IT1200 SERIES

IT1200A

Self-Contained Air-Cooled Condenser Model

Characteristics vary depending on operating conditions.

CYCLE TIMES

Freeze Time + Harvest Time = Total Cycle Time

Air Temp. Entering Condenser °F/°C	Freeze Time			Harvest Time ¹
	Water Temperature °F/°C			
	50/10	70/21	90/32	
70/21	7.5-8.4	8.1-9.0	9.6-10.6	1-2.5
80/27	8.5-9.4	9.5-10.5	10.1-11.2	
90/32	9.1-10.1	9.9-10.9	10.6-11.7	
100/38	9.9-11.0	10.8-12.0	12.2-13.4	
110/43	11.1-12.3	12.1-13.4	13.3-14.7	

1 Times in minutes

24 HOUR ICE PRODUCTION

Air Temp. Entering Condenser °F/°C	Water Temperature °F/°C ¹²		
	50/10	70/21	90/32
70/21	1195	1125	975
80/27	1085	985	930
90/32	1020	950	895
100/38	945	875	790
110/43	855	795	730

1 Based on average ice slab weight of 7.5 - 8.2 lb.

2 230/50/1 is approximately 12% lower than 230/60/1

OPERATING PRESSURES

Air Temp Entering Condenser °F/°C	Freeze Cycle		Harvest Cycle	
	Discharge Pressure PSIG	Suction Pressure PSIG ¹	Discharge Pressure PSIG	Suction Pressure PSIG
50/10	270-340	70-35	160-170	120-135
70/21	270-350	70-36	160-185	120-140
80/27	270-350	75-38	160-185	120-140
90/32	345-415	75-38	190-220	140-170
100/38	445-510	85-42	270-315	190-245
110/43	445-530	100-43	270-315	200-245

1 Suction pressure drops gradually throughout the freeze cycle

IT1200W

Self-Contained Water-Cooled Model

Characteristics vary depending on operating conditions.

CYCLE TIMES

Freeze Time + Harvest Time = Total Cycle Time

Air Temp. Around Ice Machine °F/°C	Freeze Time			Harvest Time ¹
	Water Temperature °F/°C			
	50/10	70/21	90/32	
70/21	8.5-9.4	9.6-10.7	10.6-11.7	1-2.5
80/27	8.5-9.5	9.8-10.9	10.6-11.8	
90/32	8.6-9.5	10.5-11.6	10.7-11.8	
100/38	8.6-9.6	10.6-11.8	10.8-12.0	
110/43	8.7-9.6	10.7-11.8	11.0-12.2	

1 Times in minutes

24 HOUR ICE PRODUCTION

Air Temp. Around Ice Machine °F/°C	Water Temperature °F/°C ¹²		
	50/10	70/21	90/32
70/21	1080	970	895
80/27	1075	955	890
90/32	1070	900	885
100/38	1065	890	875
110/43	1060	885	865

1 Based on average ice slab weight of 7.5 - 8.2 lb.

OPERATING PRESSURES

Air Temp Around Ice Machine °F/°C	Freeze Cycle		Harvest Cycle	
	Discharge Pressure PSIG	Suction Pressure PSIG ¹	Discharge Pressure PSIG	Suction Pressure PSIG
50/10	330-335	65-36	155-165	125-135
70/21	330-335	65-38	155-165	125-135
80/27	330-335	75-38	155-170	120-135
90/32	330-335	75-39	155-170	125-135
100/38	330-335	75-40	155-170	125-140
110/43	330-345	80-42	155-175	125-140

1 Suction pressure drops gradually throughout the freeze cycle

2 Water regulating valve set to maintain 330 psig

IT1200N

Remote Air-Cooled Condenser Model

Characteristics vary depending on operating conditions.

CYCLE TIMES

Freeze Time + Harvest Time = Total Cycle Time

Air Temp. Entering Condenser °F/°C	Freeze Time			Harvest Time ¹
	Water Temperature °F/°C			
	50/10	70/21	90/32	
70/21	8.1-8.9	9.1-10.1	10.0-11.1	1-2.5
80/27	8.6-9.5	9.6-10.6	10.4-11.5	
90/32	9.2-10.2	9.8-10.8	11.0-12.2	
100/38	10.6-11.8	10.8-12.0	12.4-13.7	
110/43	12.6-8.4	12.8-14.1	14.3-15.7	

1 Times in minutes

24 HOUR ICE PRODUCTION

Air Temp. Entering Condenser °F/°C	Water Temperature °F/°C ¹		
	50/10	70/21	90/32
70/21	1130	1015	940
80/27	1070	975	910
90/32	1010	960	865
100/38	890	875	775
110/43	840	755	685

1 Based on average ice slab weight of 7.5 - 8.2 lb.

OPERATING PRESSURES

Air Temp Entering Condenser °F/°C	Freeze Cycle		Harvest Cycle	
	Discharge Pressure PSIG	Suction Pressure PSIG ¹	Discharge Pressure PSIG	Suction Pressure PSIG
-20 to 50 -29 to 10	265-280	65-42	170-180	120-130
70/21	305-330	65-42	180-195	120-145
80/27	310-345	70-44	180-205	115-155
90/32	310-380	75-45	185-205	120-155
100/38	400-460	80-50	200-215	140-155
110/43	405-475	90-50	200-220	145-160

1 Suction pressure drops gradually throughout the freeze cycle

IT1500 SERIES

IT1500A

Self-Contained Air-Cooled Model

Characteristics vary depending on operating conditions.

CYCLE TIMES

Freeze Time + Harvest Time = Total Cycle Time

Air Temp. Entering Condenser °F/°C	Freeze Time			Harvest Time ¹
	Water Temperature °F/°C			
	50/10	70/21	90/32	
70/21	9.1-10.3	9.7-11.1	11.5-13.1	1-2.5
80/27	9.9-11.3	10.8-12.3	12.6-14.3	
90/32	12.0-13.6	12.9-14.6	14.5-16.4	
100/38	13.2-15.0	14.3-16.2	16.6-18.8	
110/43	16.5-18.7	17.3-19.6	18.9-21.4	

1 Times in minutes

24 HOUR ICE PRODUCTION

Air Temp. Entering Condenser °F/°C	Water Temperature °F/°C ¹²		
	50/10	70/21	90/32
70/21	1800	1690	1460
80/27	1670	1540	1345
90/32	1410	1320	1190
100/38	1295	1205	1050
110/43	1055	1010	930

1 Based on average ice slab weight of 13.2 - 14.8 lb.

2 230/50/1 is approximately 12% lower than 230/60/1

OPERATING PRESSURES

Air Temp Entering Condenser °F/°C	Freeze Cycle		Harvest Cycle	
	Discharge Pressure PSIG	Suction Pressure PSIG ¹	Discharge Pressure PSIG	Suction Pressure PSIG
50/10	260-340	60-38	150-160	110-120
70/21	260-340	65-40	160-170	115-125
80/27	300-380	70-40	185-200	130-145
90/32	360-425	75-42	195-205	135-155
100/38	415-500	85-44	220-240	165-180
110/43	435-530	90-45	240-250	170-190

1 Suction pressure drops gradually throughout the freeze cycle

IT1500W

Self-Contained Water-Cooled Model

Characteristics vary depending on operating conditions.

CYCLE TIMES

Freeze Time + Harvest Time = Total Cycle Time

Air Temp. Around Ice Machine °F/°C	Freeze Time			Harvest Time ¹
	Water Temperature °F/°C			
	50/10	70/21	90/32	
70/21	9.1-10.3	9.7-11.1	11.5-13.1	1-2.5
80/27	10.2-11.6	10.5-11.9	12.5-14.2	
90/32	10.3-11.7	11.9-13.5	12.8-14.5	
100/38	10.3-11.8	12.5-14.2	13.0-14.7	
110/43	10.5-11.9	12.7-14.5	13.2-15.0	

1 Times in minutes

24 HOUR ICE PRODUCTION

Air Temp. Around Ice Machine °F/°C	Water Temperature °F/°C ¹		
	50/10	70/21	90/32
70/21	1725	1655	1380
80/27	1625	1585	1360
90/32	1615	1420	1330
100/38	1605	1360	1315
110/43	1590	1335	1295

1 Based on average ice slab weight of 13.2 - 14.8 lb.

OPERATING PRESSURES

Air Temp Around Ice Machine °F/°C	Freeze Cycle		Harvest Cycle	
	Discharge Pressure PSIG	Suction Pressure PSIG ¹	Discharge Pressure PSIG	Suction Pressure PSIG
50/10	310-320	70-43	155-170	105-125
70/21	310-320	70-45	160-175	115-130
80/27	315-325	70-45	165-180	115-135
90/32	315-330	75-45	170-185	120-135
100/38	320-360	80-45	175-190	125-140
110/43	320-365	80-45	175-195	125-140

1 Suction pressure drops gradually throughout the freeze cycle

2 Water regulating valve set to maintain 315 psig

IT1500N

Remote Air-Cooled Condenser Model

Characteristics vary depending on operating conditions.

CYCLE TIMES

Freeze Time + Harvest Time = Total Cycle Time

Air Temp. Entering Condenser °F/°C	Freeze Time			Harvest Time ¹
	Water Temperature °F/°C			
	50/10	70/21	90/32	
70/21	9.6-11.0	10.3-11.7	11.7-13.4	1-2.5
80/27	10.2-11.7	10.8-12.3	12.4-14.1	
90/32	10.9-12.4	11.7-13.4	13.2-15.0	
100/38	11.7-13.4	12.4-14.1	14.0-15.9	
110/43	11.9-13.5	13.2-15.0	14.7-16.7	

¹ Times in minutes

24 HOUR ICE PRODUCTION

Air Temp. Entering Condenser °F/°C	Water Temperature °F/°C ¹		
	50/10	70/21	90/32
70/21	1710	1615	1435
80/27	1620	1545	1365
90/32	1530	1435	1295
100/38	1435	1365	1225
110/43	1420	1295	1170

¹ Based on average ice slab weight of 13.2 - 14.8 lb.

OPERATING PRESSURES

Air Temp Entering Condenser °F/°C	Freeze Cycle		Harvest Cycle	
	Discharge Pressure PSIG	Suction Pressure PSIG ¹	Discharge Pressure PSIG	Suction Pressure PSIG
-20/-29	280-300	65-40	180-200	100-135
50/10	300-315	65-41	190-205	100-140
70/21	305-320	65-42	190-205	110-150
80/27	310-345	70-44	190-205	115-155
90/32	315-350	75-45	190-205	120-155
100/38	410-470	85-48	190-210	130-155
110/43	415-480	90-50	195-215	135-155

¹ Suction pressure drops gradually throughout the freeze cycle

IT1900 SERIES

IT1900A

Self-Contained Air-Cooled Model

Characteristics vary depending on operating conditions.

CYCLE TIMES

Freeze Time + Harvest Time = Total Cycle Time

Air Temp. Entering Condenser °F/°C	Freeze Time			Harvest Time ¹
	Water Temperature °F/°C			
	50/10	70/21	90/32	
70/21	8.5-9.7	9.7-11.0	10.4-11.8	1-2.5
80/27	8.9-10.2	10.9-12.4	11.7-13.4	
90/32	10.0-11.4	12.0-13.6	13.5-15.3	
100/38	12.0-13.6	13.8-15.6	15.7-17.8	
110/43	14.8-16.8	16.1-18.2	17.0-19.3	

1 Times in minutes

24 HOUR ICE PRODUCTION

Air Temp. Entering Condenser °F/°C	Water Temperature °F/°C ¹²		
	50/10	70/21	90/32
70/21	1900	1700	1600
80/27	1820	1535	1435
90/32	1655	1410	1270
100/38	1410	1245	1105
110/43	1165	1080	1025

1 Based on average ice slab weight of 13.2 - 14.8 lb.

2 230/50/1 is approximately 12% lower than 230/60/1

OPERATING PRESSURES

Air Temp Entering Condenser °F/°C	Freeze Cycle		Harvest Cycle	
	Discharge Pressure PSIG	Suction Pressure PSIG ¹	Discharge Pressure PSIG	Suction Pressure PSIG
50/10	265-340	55-33	160-175	100-120
70/21	270-345	60-34	165-180	110-130
80/27	300-410	65-36	180-200	120-140
90/32	335-420	75-38	200-210	130-150
100/38	390-515	80-44	230-250	160-180
110/43	425-525	85-45	250-260	170-185

1 Suction pressure drops gradually throughout the freeze cycle

IT1900W

Self-Contained Water-Cooled Model

Characteristics vary depending on operating conditions.

CYCLE TIMES

Freeze Time + Harvest Time = Total Cycle Time

Air Temp. Around Ice Machine °F/°C	Freeze Time			Harvest Time ¹
	Water Temperature °F/°C			
	50/10	70/21	90/32	
70/21	8.7-9.9	9.5-10.8	11.3-12.8	1-2.5
80/27	8.9-10.1	9.8-11.1	11.7-13.2	
90/32	9.0-10.3	10.4-11.8	11.9-13.6	
100/38	9.1-10.4	11.0-12.6	12.2-13.9	
110/43	9.4-10.7	11.4-13.0	12.4-14.0	

1 Times in minutes

24 HOUR ICE PRODUCTION

Air Temp. Around Ice Machine °F/°C	Water Temperature °F/°C ¹		
	50/10	70/21	90/32
70/21	1870	1730	1490
80/27	1830	1685	1445
90/32	1810	1600	1360
100/38	1790	1515	1315
110/43	1740	1470	1365

1 Based on average ice slab weight of 13.2 - 14.8 lb.

OPERATING PRESSURES

Air Temp Around Ice Machine °F/°C	Freeze Cycle		Harvest Cycle	
	Discharge Pressure PSIG	Suction Pressure PSIG ¹	Discharge Pressure PSIG	Suction Pressure PSIG
50/10	310-320	60-38	165-180	110-125
70/21	310-320	60-38	165-180	115-125
80/27	310-320	65-38	165-190	115-130
90/32	310-320	70-38	175-195	120-135
100/38	320-360	75-38	180-200	120-140
110/43	330-370	75-38	180-200	120-140

1 Suction pressure drops gradually throughout the freeze cycle

2 Water regulating valve set to maintain 315 psig

IT1900N

Remote Air-Cooled Condenser Model

Characteristics vary depending on operating conditions.

CYCLE TIMES

Freeze Time + Harvest Time = Total Cycle Time

Air Temp. Entering Condenser °F/°C	Freeze Time			Harvest Time ¹
	Water Temperature °F/°C			
	50/10	70/21	90/32	
70/21	8.9-10.1	9.4-10.7	11.0-12.5	1-2.5
80/27	9.4-10.7	10.0-11.4	11.8-13.4	
90/32	10.2-11.6	10.8-12.3	12.9-14.6	
100/38	11.7-13.4	12.6-14.3	14.0-15.8	
110/43	13.7-15.5	14.0-15.8	14.3-16.2	

1 Times in minutes

24 HOUR ICE PRODUCTION

Air Temp. Entering Condenser °F/°C	Water Temperature °F/°C ¹		
	50/10	70/21	90/32
70/21	1830	1740	1520
80/27	1740	1650	1430
90/32	1625	1540	1320
100/38	1435	1350	1230
110/43	1250	1230	1205

1 Based on average ice slab weight of 13.2 - 14.8 lb.

OPERATING PRESSURES

Air Temp Entering Condenser °F/°C	Freeze Cycle		Harvest Cycle	
	Discharge Pressure PSIG	Suction Pressure PSIG ¹	Discharge Pressure PSIG	Suction Pressure PSIG
-20/-29	260-290	65-38	170-180	110-130
50/10	270-330	70-38	170-180	115-130
70/21	280-340	75-38	170-180	120-130
80/27	320-400	75-39	170-190	130-150
90/32	345-420	75-40	170-195	140-155
100/38	395-480	85-46	180-210	140-155
110/43	405-485	85-47	180-215	140-155

1 Suction pressure drops gradually throughout the freeze cycle

THIS PAGE INTENTIONALLY LEFT BLANK

Diagrams

Wiring Diagrams

The following pages contain electrical wiring diagrams. Be sure you are referring to the correct diagram for the ice machine you are servicing.

Warning

Always disconnect power before working on electrical circuitry.

Some components are wired differently on energy efficient machines. Please verify your model number (page 19) to reference the correct diagrams.

WIRING DIAGRAM LEGEND

The following symbols are used on all of the wiring diagrams:

- * Internal Compressor Overload
(Some models have external compressor overloads)
- ** Fan Motor Run Capacitor
(Some models do not incorporate fan motor run capacitor)
- () Wire Number Designation
(The number is marked at each end of the wire)
- >>— Multi-Pin Connection
—> (Electrical Box Side)
>— (Compressor Compartment Side)

IT0420/IT0450/IT0500/IT0620 - 1PH AIR/WATER

Self Contained Air & Water-cooled

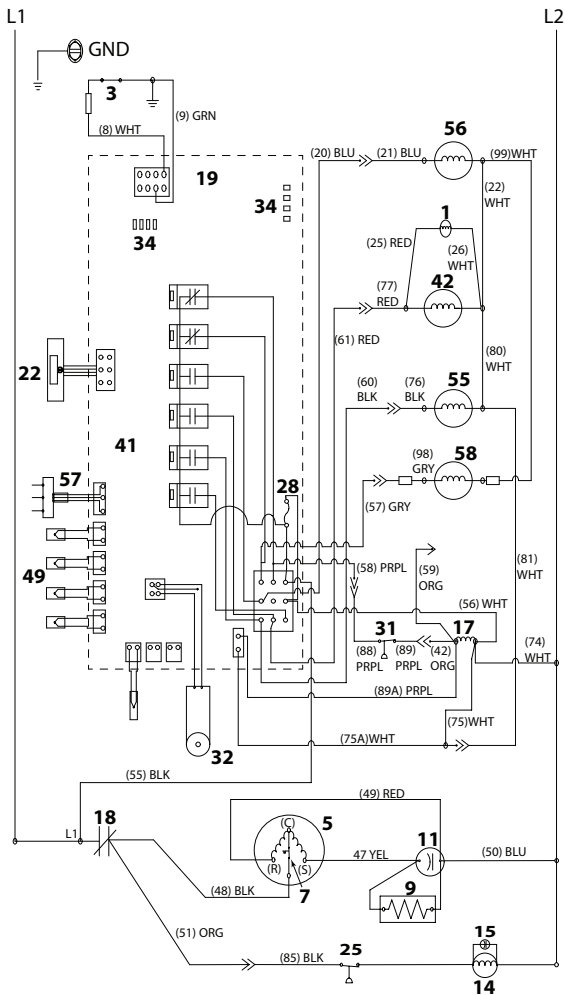

000014009_02

IT420/IT0450/IT0500/IT0620 - 1ph Air/Water

Number	Component
1	Air Pump Harvest Assist
3	Bin Switch
5	Compressor
7	Compressor Overload
9	PTCR
11	Compressor Run Capacitor
14	Condenser Fan Motor
15	Condenser Fan Motor Run Capacitor
17	Contacto Coil
18	Contacto Contacts
19	Control Board
22	Touchscreen
25	Fan Cycle Control
28	Fuse
31	High Pressure Cutout
32	Ice Thickness Probe
34	LED
41	See Control Board Schematic For Detail
42	Solenoid Valve - Harvest Left Hand
49	Thermistors
55	Water Dump Valve
56	Water Inlet Valve
57	Water Level Probe
58	Water Pump
Wire Colors	
BLK	Black
BLU	Blue
BRN	Brown
GRY	Grey
ORG	Orange
PRPL	Purple
RED	Red
WHT	White
YEL	Yellow
Refer to control board schematic for control board detail	

IT0500 - 1ph Remote

Number	Component
1	Air Pump Harvest Assist
3	Bin Switch
5	Compressor
7	Compressor Overload
8	Compressor Potential Relay
9	PTCR
11	Compressor Run Capacitor
12	Compressor Start Capacitor
14	Condenser Fan Motor
15	Condenser Fan Motor Run Capacitor
17	Contactator Coil
18	Contactator Contacts
19	Control Board
22	Touchscreen
25	Fan Cycle Control
28	Fuse
31	High Pressure Cutout
32	Ice Thickness Probe
34	LED
41	See Control Board Schematic For Detail
42	Solenoid Valve - Harvest Left Hand
45	Solenoid Valve - Liquid Line
49	Thermistors
55	Water Dump Valve
56	Water Inlet Valve
57	Water Level Probe
58	Water Pump
Wire Colors	
BLK	Black
BLU	Blue
BRN	Brown
GRY	Grey
ORG	Orange
PRPL	Purple
RED	Red
WHT	White
YEL	Yellow
Refer to control board schematic for control board detail	

IT1200/IT1500/IT1900 - 1ph Air/Water

Number	Component
1	Air Pump Harvest Assist
3	Bin Switch
5	Compressor
7	Compressor Overload
9	PTCR
11	Compressor Run Capacitor
14	Condenser Fan Motor
15	Condenser Fan Motor Run Capacitor
17	Contactator Coil
18	Contactator Contacts
19	Control Board
21	Disconnect Switch - Marine Models Only
22	Touchscreen
25	Fan Cycle Control
28	Fuse
31	High Pressure Cutout
32	Ice Thickness Probe
34	LED
41	See Control Board Schematic For Detail
42	Solenoid Valve - Harvest Left Hand
43	Solenoid Valve - Harvest Right Hand
49	Thermistors
55	Water Dump Valve
56	Water Inlet Valve
57	Water Level Probe
58	Water Pump
Wire Colors	
BLK	Black
BLU	Blue
BRN	Brown
GRY	Grey
ORG	Orange
PRPL	Purple
RED	Red
WHT	White
YEL	Yellow
Refer to control board schematic for control board detail	

IT1200/IT1500/IT1900 - 3ph Air/Water

Number	Component
1	Air Pump Harvest Assist
3	Bin Switch
5	Compressor
14	Condenser Fan Motor
15	Condenser Fan Motor Run Capacitor
17	Contactator Coil
18	Contactator Contacts
19	Control Board
21	Disconnect Switch - Marine Models Only
22	Touchscreen
25	Fan Cycle Control
28	Fuse
31	High Pressure Cutout
32	Ice Thickness Probe
34	LED
41	See Control Board Schematic For Detail
42	Solenoid Valve - Harvest Left Hand
43	Solenoid Valve - Harvest Right Hand
49	Thermistors
55	Water Dump Valve
56	Water Inlet Valve
57	Water Level Probe
58	Water Pump
Wire Colors	
BLK	Black
BLU	Blue
BRN	Brown
GRY	Grey
ORG	Orange
PRPL	Purple
RED	Red
WHT	White
YEL	Yellow
Refer to control board schematic for control board detail	

IT1200/IT1500/IT1900 - 1PH REMOTE

Remote Condenser Air Cooled

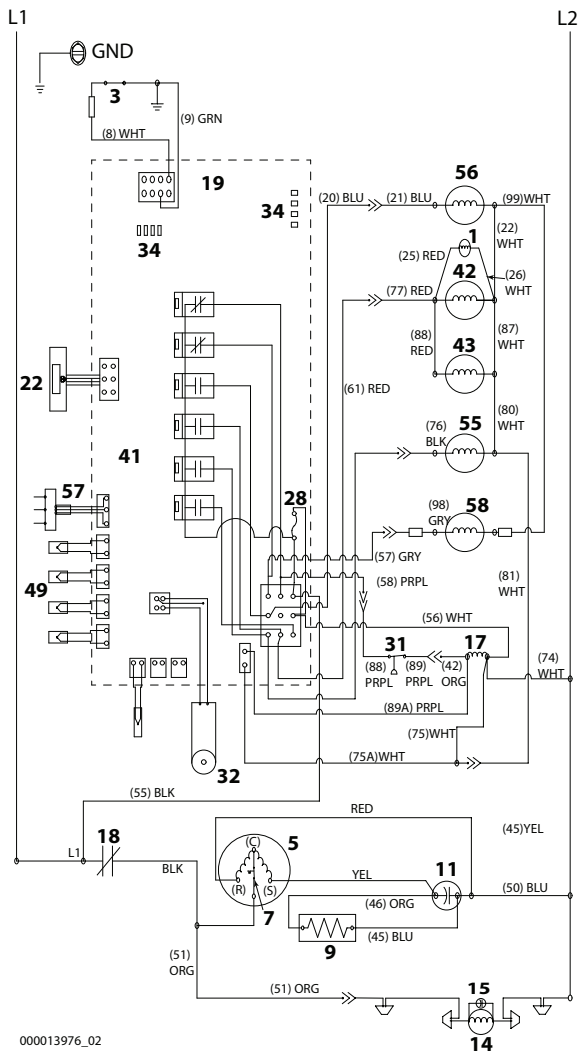

000013976_02

IT1200/IT1500/IT1900 - 1ph Remote

Number	Component
1	Air Pump Harvest Assist
3	Bin Switch
5	Compressor
9	PTCR
14	Condenser Fan Motor
15	Condenser Fan Motor Run Capacitor
17	Contactator Coil
18	Contactator Contacts
19	Control Board
22	Touchscreen
28	Fuse
31	High Pressure Cutout
32	Ice Thickness Probe
34	LED
41	See Control Board Schematic For Detail
42	Solenoid Valve - Harvest Left Hand
43	Solenoid Valve - Harvest Right Hand
49	Thermistors
55	Water Dump Valve
56	Water Inlet Valve
57	Water Level Probe
58	Water Pump
Wire Colors	
BLK	Black
BLU	Blue
BRN	Brown
GRY	Grey
ORG	Orange
PRPL	Purple
RED	Red
WHT	White
YEL	Yellow
Refer to control board schematic for control board detail	

IT1200/IT1500/IT1900 - 3PH REMOTE CONDENSER

Remote Condenser Air Cooled

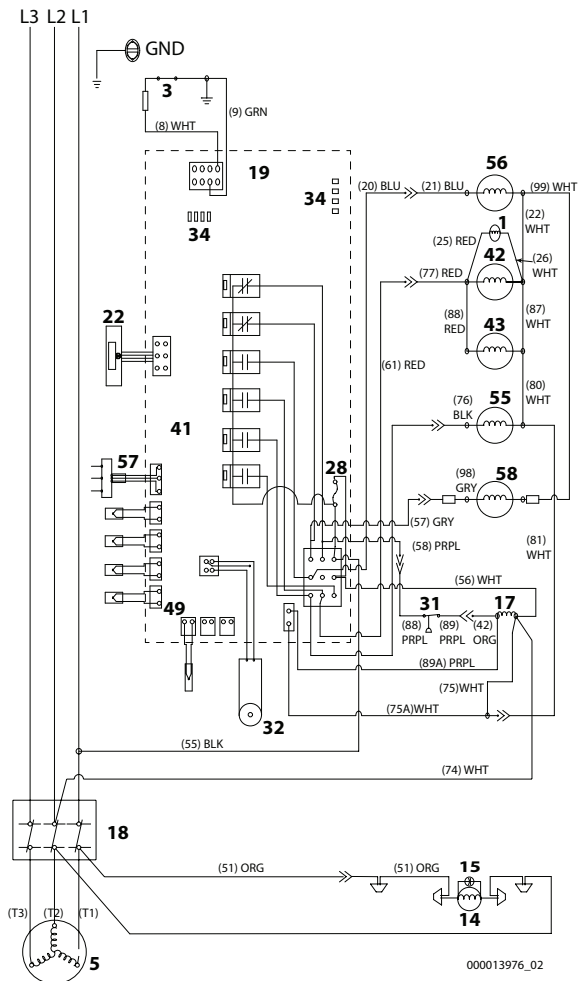

IT1200/IT1500/IT1900 - 3ph Remote

Number	Component
1	Air Pump Harvest Assist
3	Bin Switch
5	Compressor
9	PTCR
14	Condenser Fan Motor
15	Condenser Fan Motor Run Capacitor
17	Contactator Coil
18	Contactator Contacts
19	Control Board
22	Touchscreen
25	Fan Cycle Control
28	Fuse
31	High Pressure Cutout
32	Ice Thickness Probe
34	LED
41	See Control Board Schematic For Detail
42	Solenoid Valve - Harvest Left Hand
43	Solenoid Valve - Harvest Right Hand
49	Thermistors
55	Water Dump Valve
56	Water Inlet Valve
57	Water Level Probe
58	Water Pump
Wire Colors	
BLK	Black
BLU	Blue
BRN	Brown
GRY	Grey
ORG	Orange
PRPL	Purple
RED	Red
WHT	White
YEL	Yellow
Refer to control board schematic for control board detail	

Electronic Control Board

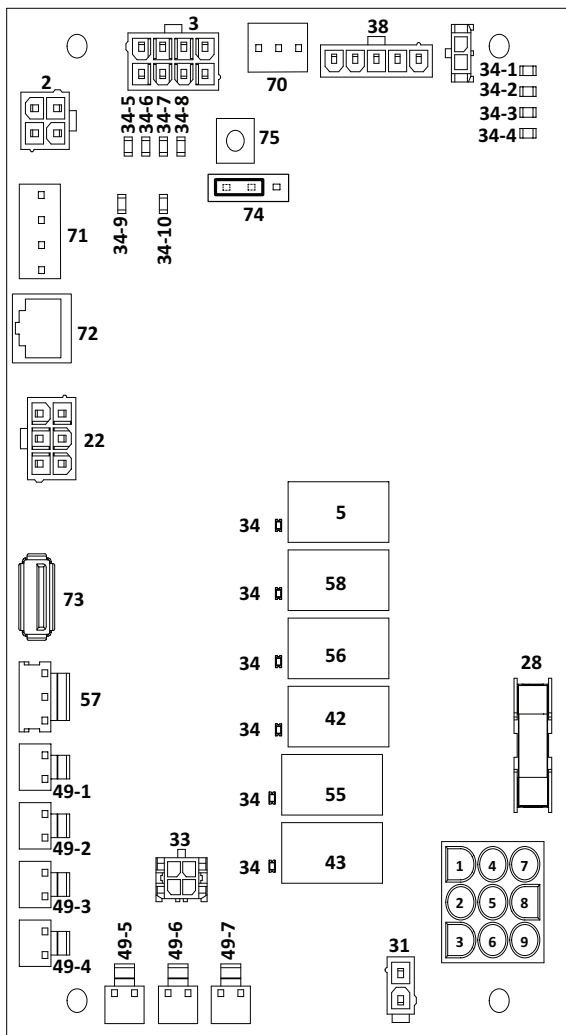

Electronic Control Board Schematic

Number	Description
2	iAuCS
3	Bin Switch
5	Compressor Contactor Coil Relay
22	Touchscreen
28	Fuse
31	High Pressure Cutout
33	Ice Thickness Probe
34	LED - Relays
34-1	LED - Display
34-2	LED - Micro
34-3	LED - Clean
34-4	LED - Harvest
34-5	LED - Ice Thickness Probe
34-6	LED - High Water Probe
34-7	LED - Low Water Probe
34-8	LED - Display Bypass Is Active
34-9	LED - Right Bin Switch
34-10	LED - Left Bin Switch
38	LuminIce
42	Relay Solenoid Valve - Harvest Left Hand
43	Relay Solenoid Valve - Harvest Right Hand
49-1	Thermistor T1 Liquid Line Temperature
49-2	Thermistor T2 - Discharge Line Temperature
49-3	Thermistor T3 - Evaporator Inlet Temperature Single Evaporator models - Evaporator Outlet Temperature Dual Evaporator Models
49-4	Thermistor T4 - Evaporator Outlet Temperature
49-5	Thermistor T5 - Bin Level Probe
49-6	Thermistor T6 - Potable water Temperature
49-7	Thermistor T7 - Ambient Air Temperature
55	Relay Water Dump Valve
56	Relay Water Inlet Valve
57	Water Level Probe
58	Relay Water Pump
70	RS232 Communication Port
71	RS485 Communication Port
72	12VDC Power Supply
73	USB Connector
74	Reverse Osmosis/De-ionized Water Usage Jumper
75	Test/Display Bypass Button

ELECTRICAL NOISE FILTER

Filter is installed to the incoming line voltage power supply on Korean models.

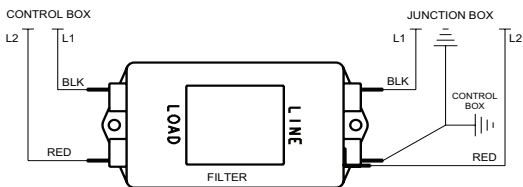

Refrigeration Tubing Schematics

SELF-CONTAINED AIR OR WATER-COOLED

IT0500/IF0600/IF0900 Self-Contained Air or Water-Cooled

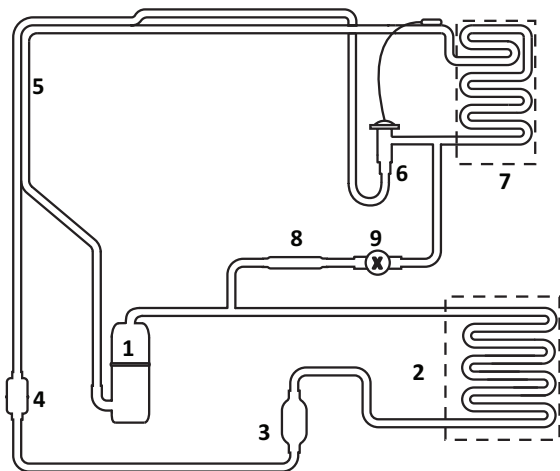

Number	Component
1	Compressor
2	Condenser - Air or Water Cooled
3	Receiver - Water Cooled Only
4	Liquid Line Filter Drier
5	Heat Exchanger
6	TXV - Thermostatic Expansion Valve
7	Evaporator
8	Strainer
9	Harvest Solenoid Valve

IT1200 Self-Contained Air or Water-Cooled

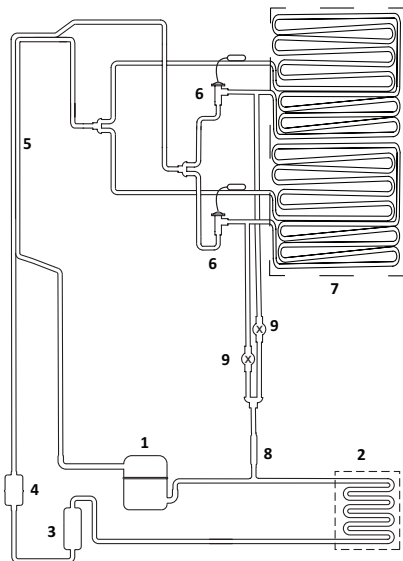

Number	Component
1	Compressor
2	Condenser - Air or Water Cooled
3	Receiver - Water Cooled Only
4	Liquid Line Filter Drier
5	Heat Exchanger
6	TXV - Thermostatic Expansion Valve
7	Evaporator
8	Strainer
9	Harvest Solenoid Valve

IT1500/IT1900 Air or Water-Cooled

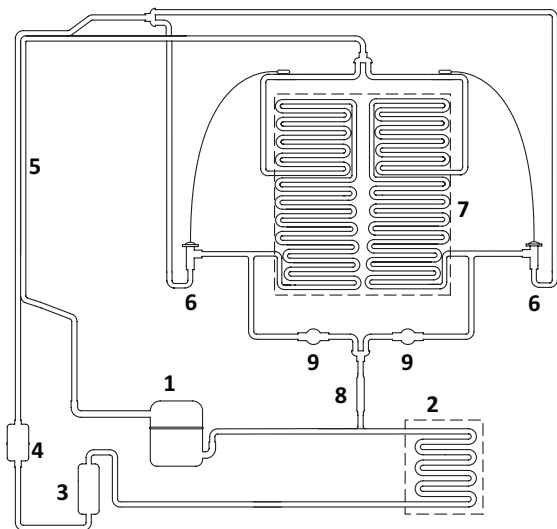

Number	Component
1	Compressor
2	Condenser - Air or Water Cooled
3	Receiver - Water Cooled Only
4	Liquid Line Filter Drier
5	Heat Exchanger
6	TXV - Thermostatic Expansion Valve
7	Evaporator
8	Strainer
9	Harvest Solenoid Valve

REMOTE AIR-COOLED CONDENSER MODELS

IT0500/IF0600/IF0900 Remote Air-Cooled Condenser

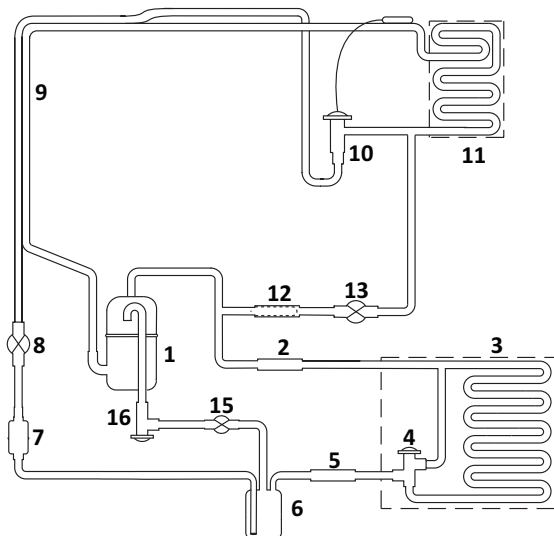

Number	Component
1	Compressor
2	Discharge Check Valve
3	Condenser - Remote Air-Cooled
4	Head Pressure Control Valve
5	Liquid Line Check Valve
6	Receiver
7	Liquid Line Filter Drier
8	Liquid Line Solenoid Valve
9	Heat Exchanger
10	TXV - Thermostatic Expansion Valve
11	Evaporator
12	Strainer
13	Harvest Solenoid Valve
15	Harvest Pressure Regulating Solenoid Valve (HPR Solenoid Valve)
16	Harvest Pressure Regulating Valve (HPR Valve)

IT1200 Remote Air Cooled Condenser

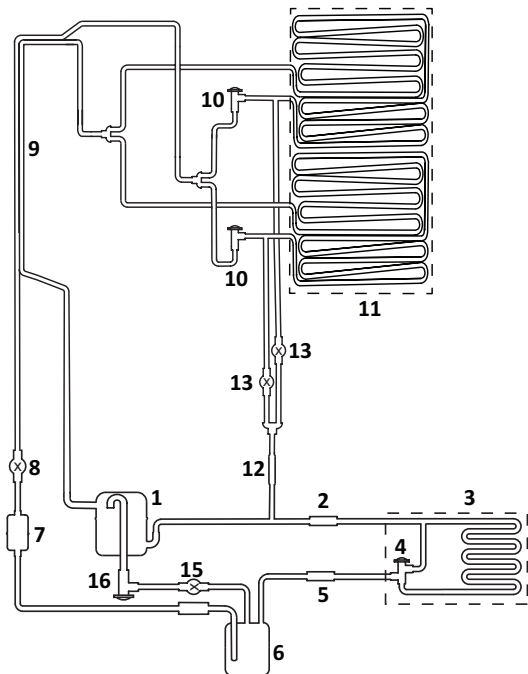

Number	Component
1	Compressor
2	Discharge Check Valve
3	Condenser - Remote Air-Cooled
4	Head Pressure Control Valve
5	Liquid Line Check Valve
6	Receiver
7	Liquid Line Filter Drier
8	Liquid Line Solenoid Valve
9	Heat Exchanger
10	TXV - Thermostatic Expansion Valve
11	Evaporator
12	Strainer
13	Harvest Solenoid Valve
15	Harvest Pressure Regulating Solenoid Valve (HPR Solenoid Valve)
16	Harvest Pressure Regulating Valve (HPR Valve)

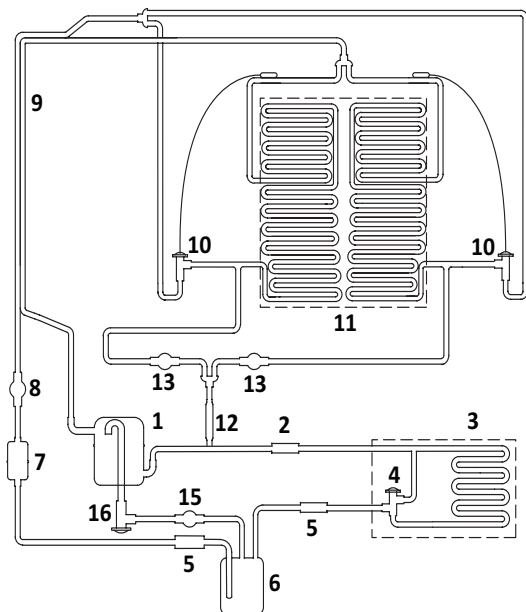

Number	Component
1	Compressor
2	Discharge Check Valve
3	Condenser - Remote Air-Cooled
4	Head Pressure Control Valve
5	Liquid Line Check Valve
6	Receiver
7	Liquid Line Filter Drier
8	Liquid Line Solenoid Valve
9	Heat Exchanger
10	TXV - Thermostatic Expansion Valve
11	Evaporator
12	Strainer
13	Harvest Solenoid Valve
15	Harvest Pressure Regulating Solenoid Valve (HPR Solenoid Valve)
16	Harvest Pressure Regulating Valve (HPR Valve)



MANITOWOC ICE
2110 SOUTH 26TH STREET
MANITOWOC, WI 54220

844-724-2273
WWW.MANITOWOCICE.COM



WELBILT[®]
Bringing innovation to the table

WWW.WELBILT.COM

Welbilt provides the world's top chefs, and premier chain operators or growing independents with industry leading equipment and solutions. Our cutting-edge designs and lean manufacturing tactics are powered by deep knowledge, operator insights, and culinary expertise.

All of our products are backed by KitchenCare[®] – our aftermarket, repair, and parts service.

▶ CLEVELAND

▶ FRYMASTER[®]

▶ MANITOWOC[®]

▶ CONVOTHERM[®]

▶ GARLAND

▶ MERCO[®]

▶ DELFIELD[®]

▶ KOLPAK[®]

▶ MERRYCHEF[®]

▶ FITKITCHEN[™]

▶ LINCOLN

▶ MULTIPLEX[®]

©2018 Welbilt Inc. except where explicitly stated otherwise.

All rights reserved.

Part Number: 000015430 5/18