

# MARS 780

## DEFINITE PURPOSE CONTACTORS



### MARS 780 Definite Purpose Contactors Feature the Following:

- **Designed for the most demanding applications**

HVAC	Industrial
Refrigeration	Lighting
Food Equipment	Welding Equipment
- **Meets the following standards-**

cULus	Canadian Heater Rated
ARI 780 & 790	SCCR 600 VAC
CE	UL File E96705
- Large Arch Window Box Lugs
- Compact Enclosed Body Design
- Push to Test Button On All Models Except 75 and 90 Amp Contactors
- Screw Attached Contact Cover On All Models
- Replacement Coils For 3 Pole Contactors
- Auxiliary Switches and Interlocks
- Silver-Cadmium Oxide Contacts

# MARS 780 Definite Purpose Contactors

## MARS 780 Definite Purpose Contactors

MARS 780 - 1 pole with shunt contactors are designed for demanding applications. The enclosed body design provides quiet operation and improved durability by reducing the intrusion of dust and dirt. Silver-cadmium oxide contacts provide increased contact life when switching inductive loads.

### Features:

- Enclosed body and coil – standard cover
- Push to test button
- Quad quick connects
- Box lugs - large window arch design
- Screw terminals and or box lugs available on 30 amp
- Coils - class F insulation



### 1 Pole with Shunt 30 - 40 Amps

MARS NO.	FURNAS NO.	FLA	LOCKED ROTOR AMPS		NON INDUCTIVE AMPS	COIL VOLTS	TERMINATION
			240V	277V			
61320	45EG10AJA, 45CG10AJA, 45DG10AJA					24	Screw Type
61321	45EG10AFA, 45CG10AFA, 45DG10AFA					120	
61322	45EG10AGA, 45CG10AGA, 45DG10AGA	30	180	180	40	208-240	
61323	45EG10ALA, 45CG10ALA, 45DG10ALA					277	
61324	45EG10AHA, 45CG10AHA, 45DG10AHA					480	
61720	45EG10AJAL					24	
61721	45EG10AFAL					120	
61722	45EG10AGAL	30	180	180	40	208-240	
61723	45EG10ALAL					277	
61724	45EG10AHAL					480	
61730	45GG10AJAL, 45FG10AJA, 45GG10AJA					24	Box Lug
61731	45GG10AFAL, 45FG10AFA, 45GG10AFA					120	
61732	45GG10AGAL, 45FG10AGA, 45GG10AGA	40	240	240	50	208-240	
61733	45GG10ALAL, 45FG10ALA, 45GG10ALA					277	
61734	45GG10AHAL, 45FG10AHA, 45GG10AHA					480	

## MARS 780 Definite Purpose Contactors

MARS 780 - 2 pole contactors are designed for demanding applications. The enclosed body design provides quiet operation and improved durability by reducing the intrusion of dust and dirt. Silver-cadmium oxide contacts provide increased contact life when switching inductive loads.

### Features:

- Enclosed body and coil – standard cover
- Push to test button
- Quad quick connects
- Box lugs - large window arch design
- Screw terminals and or box lugs available on 30 amp
- Coils - class F insulation



### 2 Pole 30 - 40 Amps

MARS NO.	FURNAS NO.	FLA	LOCKED ROTOR AMPS			NON INDUCTIVE AMPS	COIL VOLTS	TERMINATION
			240V	480V	600V			
61345	45EG20AJ, 45CG20AJ, 45DG20AJ					24	Screw Type	
61346	45EG20AF, 45CG20AF, 45DG20AF					120		
61347	45EG20AG, 45CG20AG, 45DG20AG	30	180	150	120	40		208-240
61348	45EG20AL, 45CG20AL, 45DG20AL					277		
61349	45EG20AH, 45CG20AH, 45DG20AH					480		
61745	45EG20AJL					24		Box Lug
61746	45EG20AFL					120		
61747	45EG20AGL	30	180	150	120	40	208-240	
61748	45EG20ALL					277		
61749	45EG20AHL					480		
61755	45GG20AJL, 45FG20AJ, 45GG20AJ					24	Box Lug	
61756	45GG20AFL, 45FG20AF, 45GG20AF					120		
61757	45GG20AGL, 45FG20AG, 45GG20AG	40	240	200	160	50		208-240
61758	45GG20ALL, 45FG20AL, 45GG20AL					277		
61759	45GG20AHL, 45FG20AH, 45GG20AH					480		

## MARS 780 Definite Purpose Contactors

MARS 780 - 2 pole "Large Body" contactors feature a 2 pole configuration in a 3 pole body for increased durability in demanding applications.

### Features:

- Large arch window box lugs
- Recessed push to test button
- Accepts MARS 780 and Furnas auxiliary switches
- Use standard MARS 780 replacement coils
- Dual QC coil terminals plus screw terminal for easy termination and jumper arrangements
- Coils - class F insulation



## 2 Pole - Large Body 30 - 40 Amp

MARS NO.	FURNAS NO.	FLA	LOCKED ROTOR AMPS			NON INDUCTIVE AMPS	COIL VOLTS	HORSEPOWER		TERMINATION
			240V	480V	600V			1 PH 240V	3 PH 240V	
61425	42BF15AJ, 42AF15AJ	30	180	150	120	40	24	3 HP	7.5 HP	Box Lug
61426	42BF15AF, 42AF15AF						120			
61427	42BF15AG, 42AF15AG						208-240			
61428	42BF15AL, 42AF15AL						277			
61440	42CF15AJ	40	240	200	160	50	24	5 HP	10 HP	Box Lug
61441	42CF15AF						120			
61442	42CF15AG						208-240			
61443	42CF15AL						277			

### Tech Tips

#### Power lead attachment:

- Box lugs for 40 Amp and below contactors should be torqued to 40 inch pounds.
  - Screw terminals for 30 Amp and below contactors are torqued to 25 inch pounds.
- Do not use drill drivers / screw guns / impact drivers to torque contactor screws or box lugs.

Three Phase power shifts can usually be identified by examining the 3 pole contactor.

#### Typical indicators of a phase failure or out of phase power:

- One set of contacts is left in good condition.
- One set of contacts will show signs of over heating.
- One set of contacts are usually burnt and charred.

#### Before replacing the contactor confirm the following:

- Have a qualified electrician confirm the 3 phase power is correct and there are no issues with the transformer.
- Confirm the 3 phase motor or compressor has not been damaged and that all 3 motor windings are operational.

CAUTION: Confirm all electrical power is turned off to the equipment you are servicing. Utilize a qualified and licensed electrician for testing and repairs.

# MARS 780 Definite Purpose Contactors

## MARS 780 - 3 Pole Contactors

MARS 780 - 3 pole contactors are designed for demanding applications. The enclosed body design provides quiet operation and improved durability by reducing the intrusion of dust and dirt. Side attachment rails for auxiliary switches (30-60 amp contactors) allow attachment of MARS 780 or Furnas auxiliary switches. Silver-cadmium oxide contacts provide increased contact life when switching inductive loads.

### Features:

- Large arch window box lugs
- SEMS screws or box lugs available on 30 amp contactors
- Recessed push to test button (not on 75 and 90 amp contactors)
- Enclosed body design
- Accepts MARS 780 and Furnas auxiliary switches
- Use standard MARS 780 replacement coils
- Dual QC coil terminals plus screw terminal for easy termination and jumper arrangements
- Coils - class F insulation • 600 volt rating • Foot print compatible

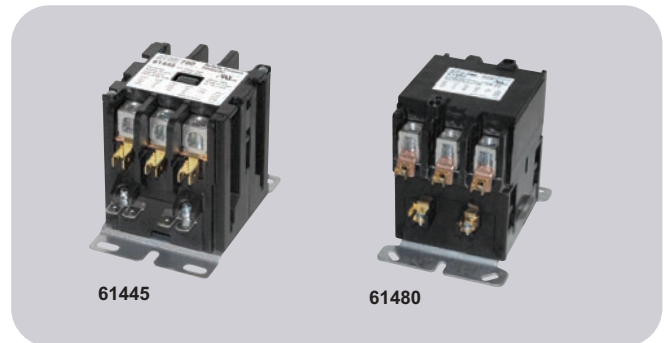

### 3 Pole 30 - 90 Amp

\* For 25 Amp Contactors - Use 30 Amp in Place of 25Amp

MARS NO.	FURNAS NO.	FLA	LOCKED ROTOR AMPS			NON INDUCTIVE AMPS	COIL VOLTS	HORSEPOWER				TERMINATION
			240V	480V	600V			1 PH 240V	240V	3 PH 480V	600V	
61430*	42BF35AJ	30	180	150	120	40	24	3 HP	7.5 HP	10 HP	15 HP	Screw Type
61431*	42BF35AF						120					
61432*	42BF35AG						208-240					
61433*	42BF35AL						277					
61434*	42BF35AH						480					
61750	-	30	180	150	120	40	24	3 HP	7.5 HP	10 HP	15 HP	Box Lug
61751	-						120					
61752	-						208-240					
61753	-						277					
61754	-						480					
61445	42CF35AJ	40	240	200	160	50	24	5 HP	10 HP	15 HP	20 HP	Box Lug
61446	42CF35AF						120					
61447	42CF35AG						208-240					
61448	42CF35AL						277					
61449	42CF35AH						480					
61460	42DF35AJ	50	300	250	200	63	24	5 HP	15 HP	20 HP	25 HP	Box Lug
61461	42DF35AF						120					
61462	42DF35AG						208-240					
61463	42DF35AL						277					
61464	42DF35AH						480					
61470	42EF35AJ	60	360	300	240	75	24	7.5 HP	20 HP	25 HP	30 HP	Box Lug
61471	42EF35AF						120					
61472	42EF35AG						208-240					
61473	42EF35AL						277					
61474	42EF35AH						480					
61480	42FE35AJ106	75	450	375	300	94	24	15 HP	25 HP	40 HP	40 HP	Box Lug
61481	42FE35AF106						120					
61482	42FE35AG106						208-240					
61483	42FE35AL106						277					
61484	42FE35AH106						480					
61490	42GE35AJ106	90	540	450	360	120	24	15 HP	30 HP	50 HP	50 HP	Box Lug
61491	42GE35AF106						120					
61492	42GE35AG106						208-240					
61493	42GE35AL106						277					
61494	42GE35AH106						480					



## 30-40A 1 Pole with Shunt

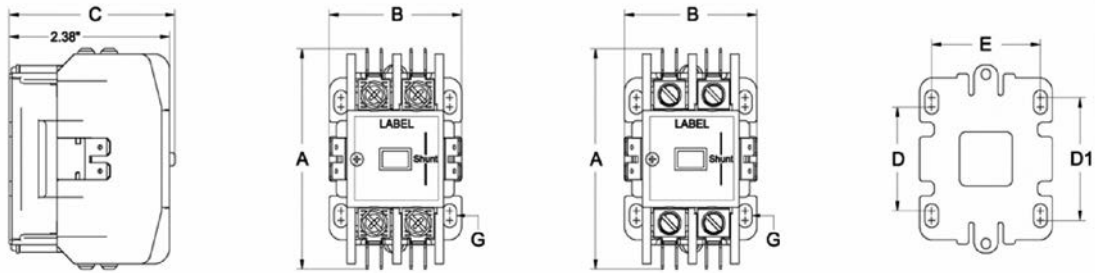

## 30-40A 2 Pole

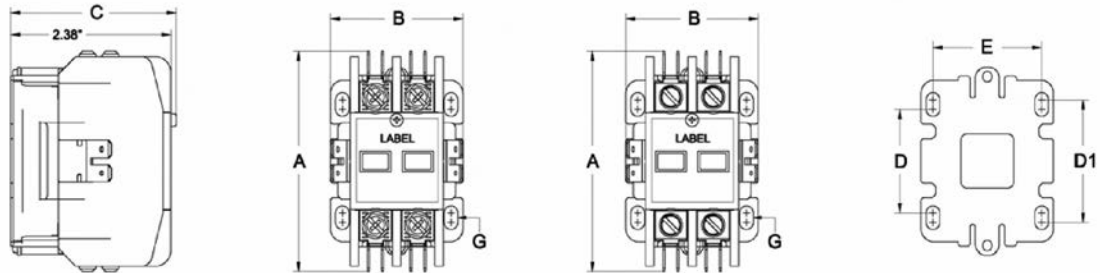

## 30-40A 2\* Pole & 3 Pole

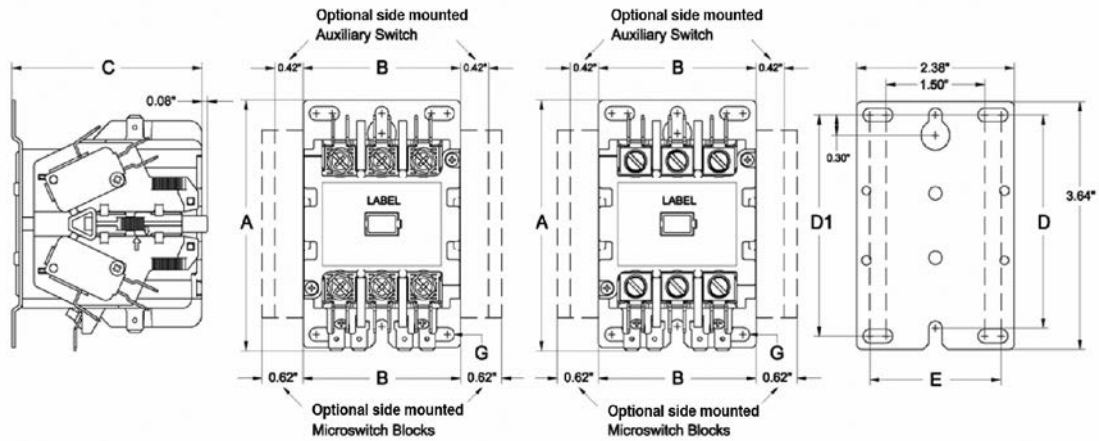

Note - 2\* Pole is a 3 pole body with center contacts removed.

MARS NO.	FLA	POLES	A	B	C	D	D1	E	MTG SCREW G	MAX WIRE SIZE
61320-61324	30	1	3.19	1.97	2.46	1.5	1.77	1.61	10	8
61720-61724 61730-61734	30-40	1	3.19	1.97	2.46	1.5	1.77	1.61	10	4
61345-61349	30	2	3.19	1.97	2.46	1.5	1.77	1.61	10	8
61745-61749 61755-61759	30-40	2	3.19	1.97	2.46	1.5	1.77	1.61	10	4
61430-61434	30	3	3.69	2.38	2.87	3.13	3.25	1.98	10	8
61750-61754 61445-61449	30-40	3	3.69	2.38	2.87	3.13	3.25	1.98	10	4
61425-61428 61440-61443	30-40	2(at 3P)*	3.69	2.38	2.87	3.13	3.25	1.98	10	4

# MARS 780 Definite Purpose Contactors

## 50-60A 3 Pole

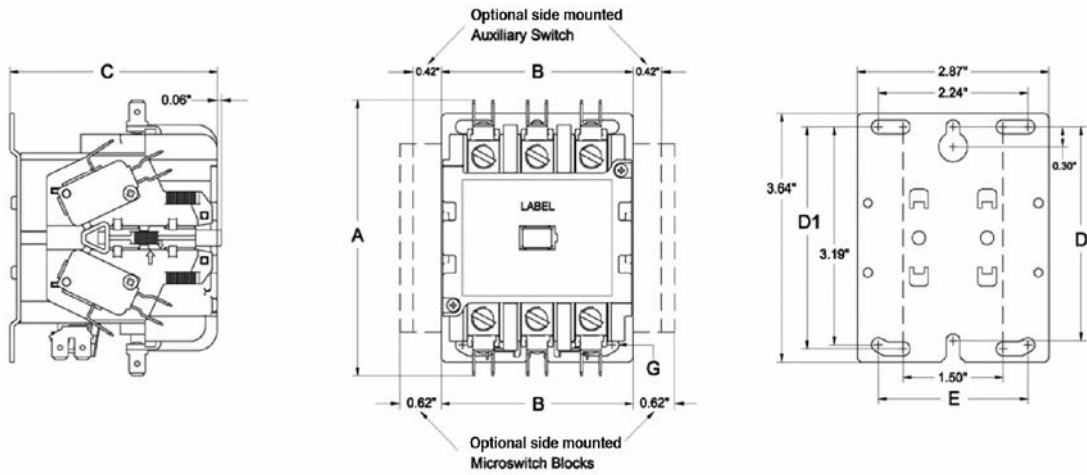

## 75-90A 3 Pole

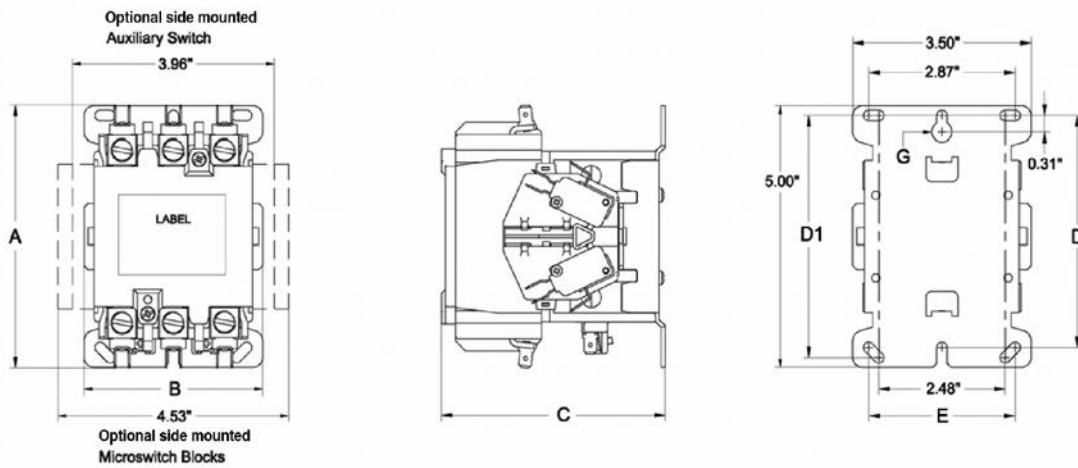

MARS NO.	FLA	POLES	A	B	C	D	D1	E	MTG SCREW G	MAX WIRE SIZE
61460-61464 61470-61474	50-60	3	4.04	2.87	3.11	3.13	3.25	2.24	10	2
61480-61484 61490-61494	75-90	3	5.02	3.5	4.39	4.43	4.63	2.87	10	1/10

## Renewal Parts and Accessories

- Snap on side mounted auxiliary switches
- Replacement coils

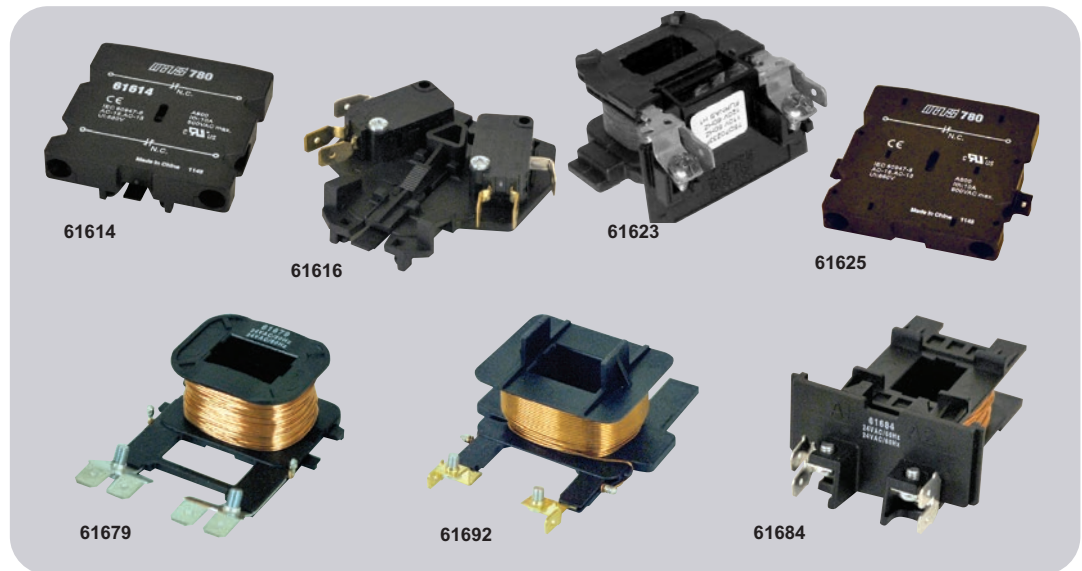

## Auxiliary Switches

MARS NO.	FURNAS NO.	DESCRIPTION	CONTACTOR F.L.A.	USED ON		
61610	49ACRO	1 NO	30 - 60	61320-61324 61720-61724 61730-61734 61345-61349 61745-61749 61755-61759 61430-61434 61750-61754 61445-61449 61425-61428 61440-61443 61460-61464 61470-61474		
61611	49ACRC	1 NC				
61612	49ACR6	1 NO- 1 NC				
61613	49ACR7	2 NO				
61614	49ACR8	2 NC				
61615	49D36098001	SPDT				
61616	49D36098003	DPDT				
61623	-	SPDT			75-90	61480-61484 61490-61494
61624	-	1 NO				
61625	-	1 NC				

## MARS 780 Replacement Coils

MARS NO.	FURNAS NO.	CONTACTOR SIZE	COIL VOLTAGE
61679	-	3 Pole 30-40 Amp	24V
61680	-		120V
61681	-		208-240V
61682	-		277V
61683	-		480V
61684	-	3 Pole 50-60 Amp	24V
61685	-		120V
61687	-		208-240V
61690	-		277V
61691	-		480V
61692	-		3 Pole 75-90 Amp
61693	-	120V	
61694	-	208-240V	
61695	-	277V	
61696	-	480V	

## MARS 780 Contactor Coil Characteristics

Contactor Series	Inrush VA	Sealed VA	Sealed Watts
1 Pole with shunt 30 to 40 amp	40	7.5	2.5 - 3.5
2 Pole - Small Body 30- 40 Amp	45	8	2.5 - 4.0
2 Pole Large Body 30- 40 Amp	90	16	3.5 - 5.0
3 Pole 30 - 40 Amp	90	16	3.5 - 5.0
3 Pole 50 - 60 Amp	145	20	5.0 - 7.0
3 Pole 75 - 90 Amp	235	32	10.0 - 12.0



**Technical Helpline:  
800.678.9888**

**[www.marsdelivers.com](http://www.marsdelivers.com)**