



This manual covers the following models:

- **R251W** (Requires T955W)

Congratulations on purchasing a PRO1 Wireless System.

This remote sensor was designed to the highest reliability and ease of use standards. Thank you for choosing Pro1.



Caution:

Equipment damage hazard

Do not operate the cooling system if the outdoor temperature is below 50° F (10° C) to prevent possible compressor damage.

Table of Contents	Page
Quick Reference	2
Mounting Locations	3
Mounting Options	4
Installing Batteries	5
New Features On T955W	6
Contact Information & Warranty	7

Need Help?

For assistance with this product please visit <http://www.pro1iaq.com> or call Pro1 Customer Care toll-free at 888-Pro1iaq (776-1427) during normal business hours (Mon-Fri 9 AM - 6 PM Eastern)

Una versión española de este manual puede ser descargada en www.pro1iaq.com

Getting to know your indoor remote sensor R251W



- ② **Glow in the Dark Light Button ***
- ③ **Temperature Setpoint Keys ****
- ④ **Remote Name**
- ⑤ **Run and Clean Keys ****

*** NOTE ABOUT THE LIGHT BUTTON:**

This button is used to light up the display. DO NOT hold the light button down for longer than 3 seconds or you will enter the technician setup screens. If you inadvertently enter the tech setup press and release the light button a second time to exit the tech screens.

**** NOTE ABOUT SETPOINT, RUN AND CLEAN KEYS:** These keys will only be shown if they have been turned on in Technician Setup menu.



Mercury Notice:

All of Pro1's products are mercury free. However, if the product you are replacing contains mercury, dispose of it properly. Your local waste management authority can give you instructions on recycling and proper disposal.

① LCD

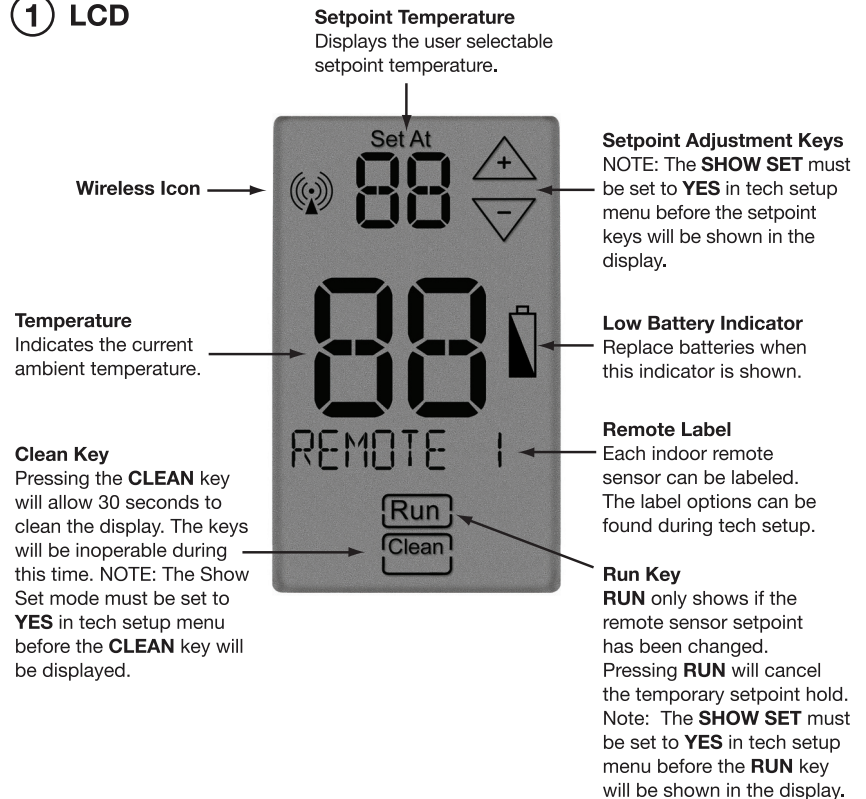

Wireless Range

Range between the R251W and the T955W master thermostat is up to 100 feet with no obstructions and up to 50 feet in standard residential metal, brick, and concrete construction.

Remote Sensor Locations

The remote sensor should be mounted or placed approximately 4 to 5 feet above the floor. Select an area with average temperature and good air circulation.

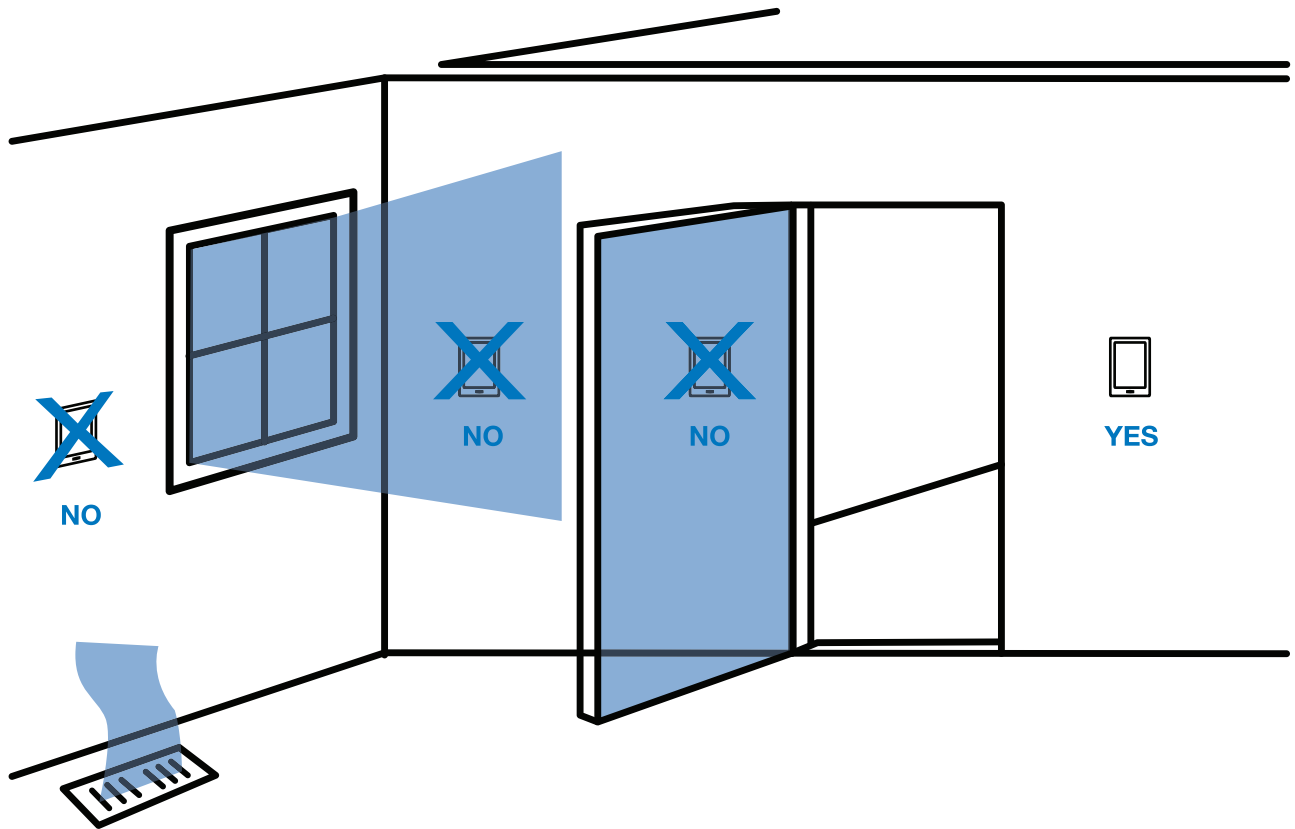

Do not mount or place Remote Sensors in locations:

- Close to hot or cold air ducts
- That are in direct sunlight
- With an outside wall behind the thermostat
- In areas that do not require conditioning
- Where there are dead spots or drafts (in corners or behind doors)
- Where appliances could radiate heat
- Do not set it next to or on hot appliances
- Do not put it in your pocket or hold in your hands for a long period of time. Body heat will distort the temperature reading.

Wireless Range

Range between the R251W and the T955W master thermostat is up to 100 feet with no obstructions and up to 50 feet in standard residential metal, brick, and concrete construction.

Wall Mount - Removeable

- 1 Mount T-bracket on the Wall.

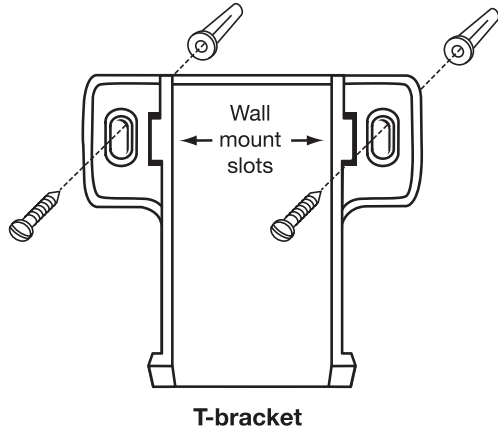

- 2 Slide the Remote Sensor over the mounted T-bracket.

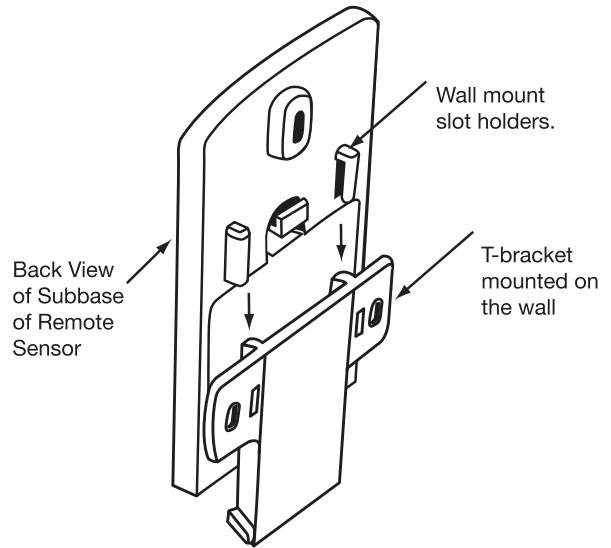

Desk or Counter Option

- 1 Slide the T-bracket up into the slot holders.

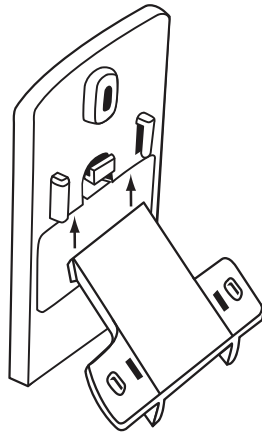

- 2 T-bracket will stop on the top of the slot holders.

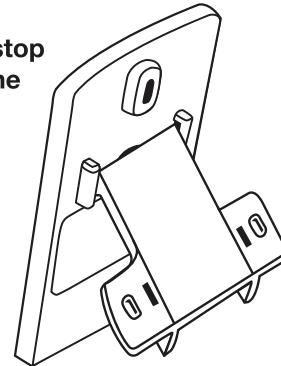

Wall Mount - Permanent

- 1 Remove the R251W from the subbase.

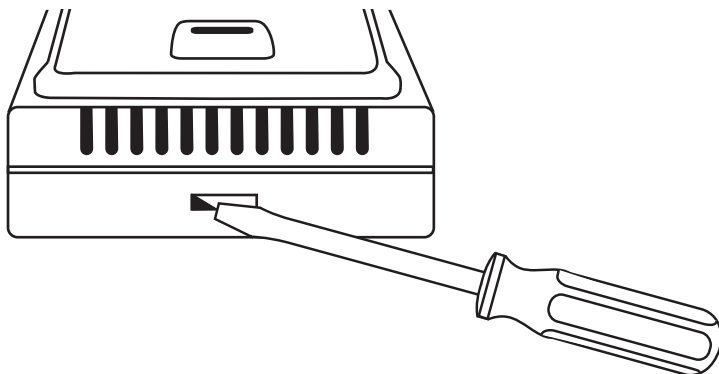

- 2 Mount subbase to the wall

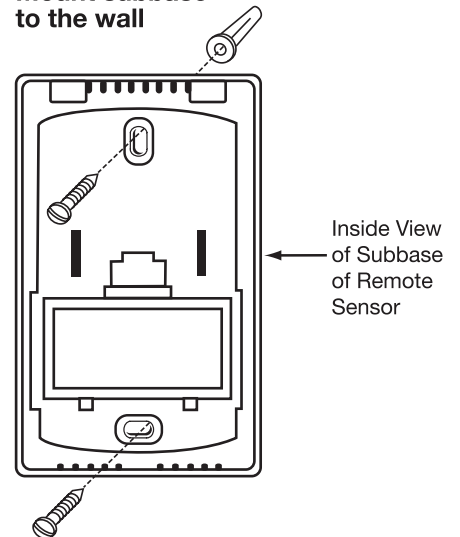

Installing Batteries for Temporary Wall Mount or Table Placement

- 1 Use the finger tab on the back of the remote to remove the battery door.



- 2 Once you have removed the door from the back of the remote, insert 2 AA Alkaline batteries and replace the battery door.



Inserting Batteries for Permanent Wall Mount

- 1 Remove the R251W from the subbase. The R251W is held on the subbase by a plastic tab on the bottom of the remote sensor. Push in with a small flat head screwdriver to remove the R251W from the subbase.

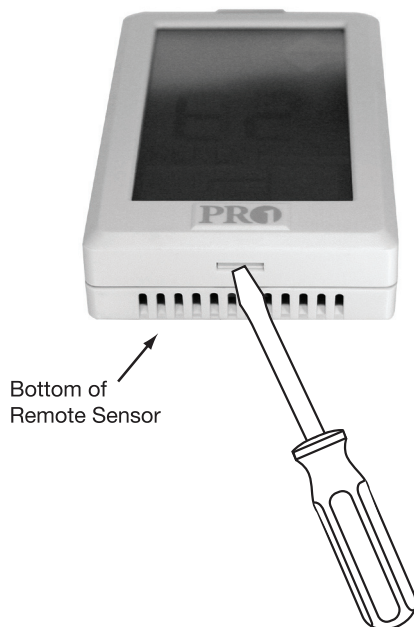

- 2 Once you have removed the R251W from the subbase, insert 2 AA Alkaline batteries.

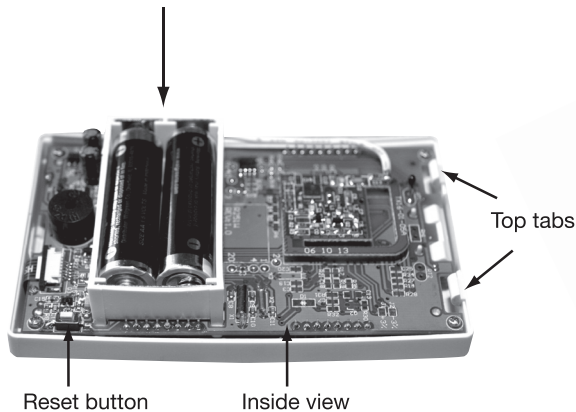

- 3 Attach the R251W to the subbase by aligning the two top tabs and then close as shown.

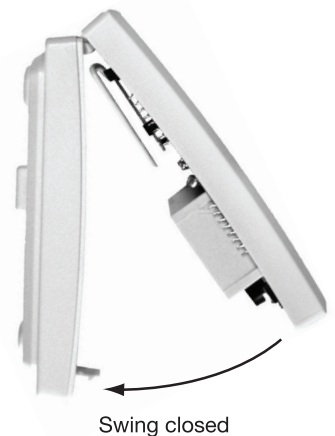

Example of programming a priority for the SLEEP time period:

In this example system we have 1 T955W on the main floor and 1 R251W in the Master Bedroom on the 2nd floor. During the setup process the R251W was named Bedroom 1. During WAKE, LEAVE and RETURN, the program should remain on system average. When on the SLEEP time period during programming, press NEXT ZONE until Bedroom 1 shows. During the SLEEP time period the other remotes in the house will be ignored and the system will be controlled only by the ambient temperature of the R251W in the master bedroom. The WAKE, LEAVE and RETURN temperature will be controlled by the system average.

New Features on the T955W After R251W is Connected

NEXT ZONE KEY

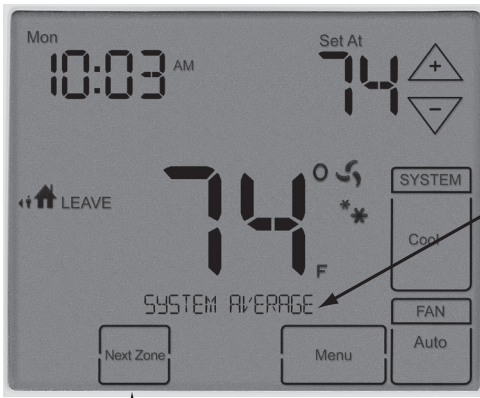

NEXT ZONE key cycles through ambient temperatures for connected zones.

In this example, the name of the zone currently having priority is **SYSTEM AVERAGE**.

System average is the average of all connected sensors.

Local is the ambient temperature of the **T955W**.

The name of the **R251W** can be displayed. This shows it has priority.

SETPOINT NOT DISPLAYED



Setpoint will only be displayed for the zone currently being used by the program or in hold. Press the Δ or ∇ to show the setpoint for adjustment.

THERMOSTAT HOLD (PERMANENT)

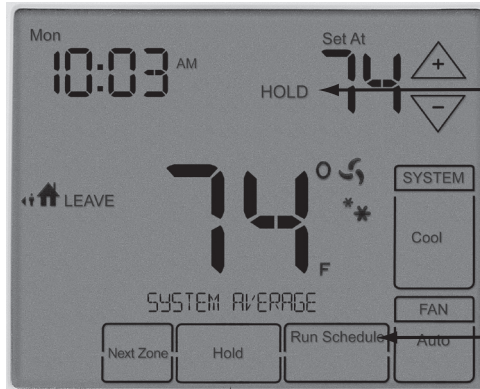

To put the thermostat into hold select system average or the zone you want to hold. Then use the arrows to adjust the setpoint. Then press the **HOLD** key.

HOLD: Indicates the T955W is in permanent **HOLD**. A permanent **HOLD** can be active for system average, local, or any **R251W**.

Run Schedule: Will cancel any holds and return the system to the program.

TEMPORARY HOLD (4 HOURS)

REMOTE: Indicates the **T955W** is in temporary hold. The setpoint will now display the temporary override setpoint.



The name of the remote sensor will be displayed. In this example, it is **REMOTE 2**.

Run Schedule: Will cancel any holds and return the system to the program.

Contact Us Information

Pro1 IAQ Inc.

1111 S. Glenstone
Suite 2-100
Springfield, MO 65804

Toll-free: 1-888-Pro1iaq (776-1427)

Toll Number (Outside the USA): 330-821-3600

Web: <http://www.pro1iaq.com>

Hours of Operation: Monday - Friday 9 AM - 6 PM Eastern

Warranty Registration:

Your new Pro1 thermostat has a 5 year limited warranty. You must register your warranty within 60 days of installation. You can register your new thermostat in 2 ways.

- ① Go to www.pro1iaq.com, select warranty registration and fill out a short registration form.
- or -
- ② Complete the form below and mail it to the address shown.

Pro1 IAQ Warranty Registration:

Name: _____

Address: _____

City: _____

State: _____

Zip: _____

Thermostat Model: _____

Date Installed: _____

Complete form and mail to:

Pro1 IAQ Inc.

1111 S. Glenstone
Suite 2-100
Springfield, MO 65804