

**HVAC/R
Service Products**



Condensate pumps

Edition 4

Combi



Quiet mode:

Installer configurable pump performance using dip-switches to optimize each individual installation for the best performance and sound parameters.



Diagnostic LED:

Patented two color long-life LED to ensure correct initial installation and to assist in diagnostics on future service calls.



USB connection:

Patented access for wholesalers or installing contractors to review pump history.



Digital sensor:

Unique digital water level sensor with no moving parts to get stuck or clogged.



Universal application:

Widest application range for exposed mount pumps in the market from 6,000 Btu/H to 120,000 Btu/H (1.75kW to 35kW).



Integrated replaceable 10 A fuse:

Factory installed replaceable 5 x 20 mm 10A fuse.

The Combi condensate pump is an entirely new design specifically manufactured for use in duct-free air conditioning split systems. The Combi is full of custom features that are unique to the world market.

The flow range, optional configuration and universal voltage allow both installing contractors and wholesalers to stock and use a single product that fulfills all your requirements.

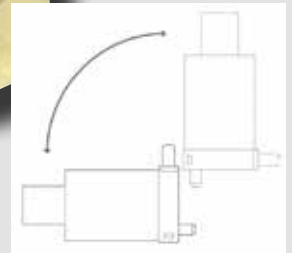
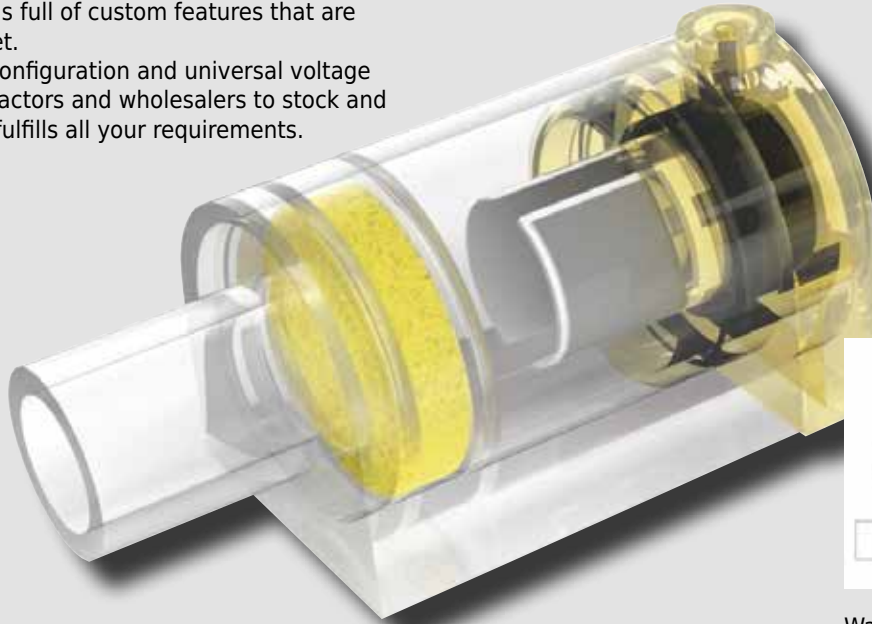

Water sensor can be used horizontally or vertically.

Technical information

- Maximum flow rate: 11 GPH
- Maximum suction: 10 ft. self priming
- Maximum head: 65.60 ft.
- Maximum horizontal run: 330 ft. at 0 head and 0 suction
- Sound: 20dBA at 1 m running (19dBa at 1 m DIN EN ISO 3741:2011 / DIN EN ISO 3744:2010)
- Voltage: 100 ~ 240 VAC 50/60 Hz auto sensing universal power input
- Power: 12 watts during maximum operation at 110v
- Alarm relay: 10 Amps NO/NC contacts with integrated replaceable 10A fuse 5 x 20 mm
- Weight: 0.63 Lbs.
- Discharge star tube: 1/4" I.D. x 3.3 ft.
- Protection: Class II double insulation, Fully potted, IP-44
- Ambient and water: 41 °F to 104 °F

Part No 3004046

Capacity

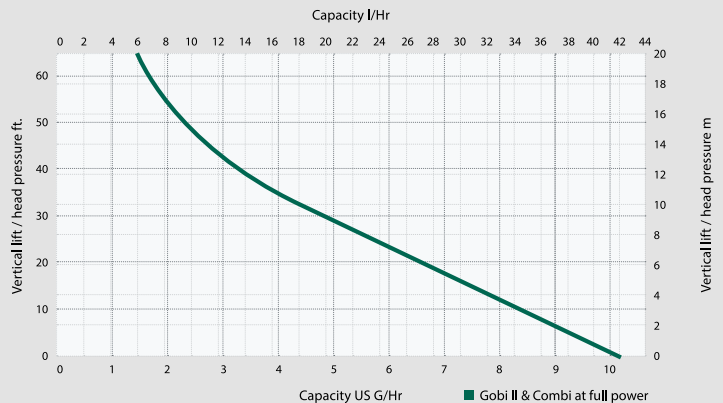

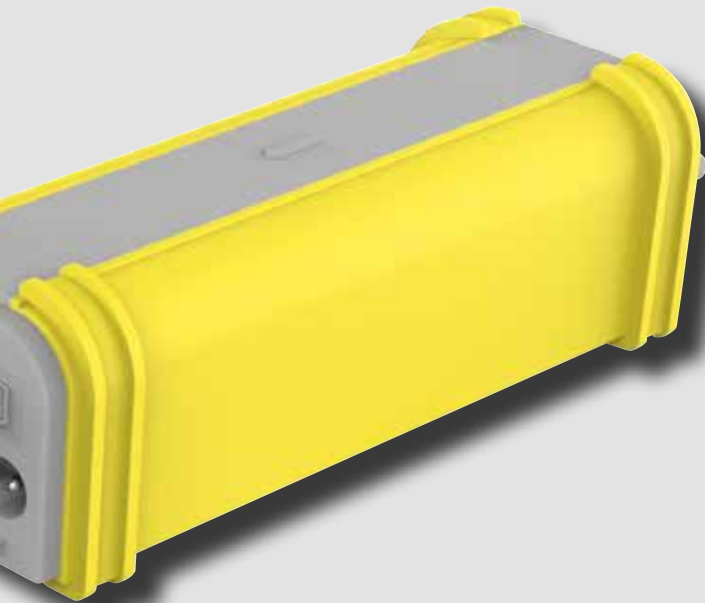

Combi kit includes

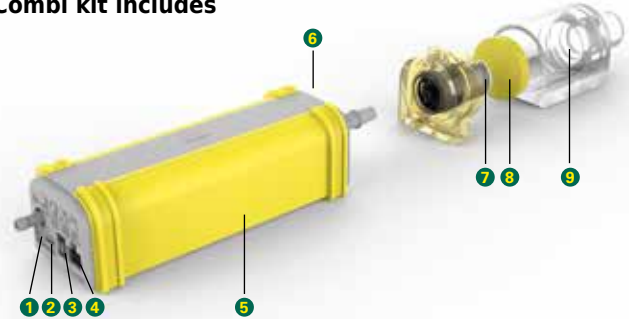

- 1 Diagnostic LED
- 2 USB port
- 3 Dip-switches
- 4 Water sensor plug
- 5 Pump body
- 6 Factory-installed fuse
- 7 Digital sensor
- 8 Replacable filter
- 9 Water sensor

Provided accessories

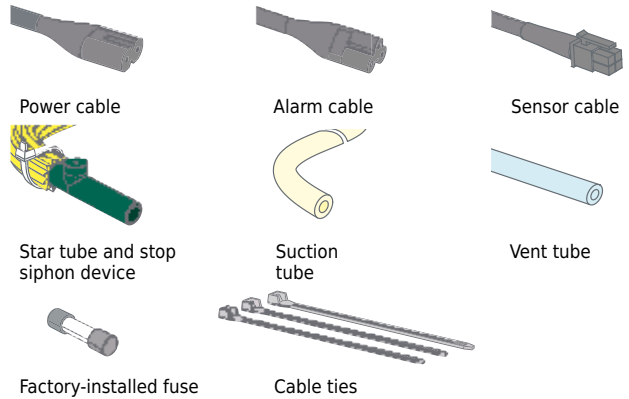

Application

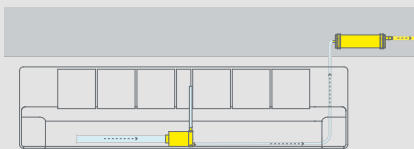

Water sensor in the AC unit, pump in the ceiling.

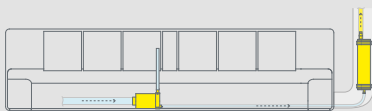

Water sensor inside the AC unit and pump outside the unit.



Water sensor and pump in the AC unit next to each other.

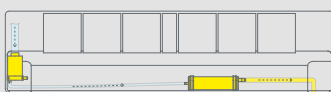

Water sensor vertical and pump in the AC unit.

Dimensions pump



Dimensions water sensor

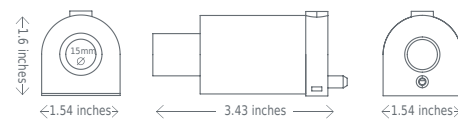

Replacement parts

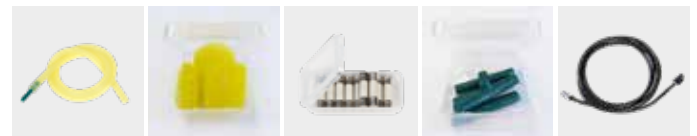

| | | | | |
|---|---|--|---|--|
| KIT-4087 Star tube with Stop-Siphon Device Part No 3004087 | FIL-4063/4 Filter, 4 pcs. Part No 3004063 | FUS-4050/10 Fuses 5x20 10A, 10 pcs. Part No 3004050 | HSG-4065/4 Stop-Siphon Device, 4 pcs. Part No 3004065 | CAB-4007 Water sensor cable Part No 4687950 |
|---|---|--|---|--|

Gobi II



Quiet mode:

Installer configurable pump performance using dip-switches to optimize each individual installation for the best performance and sound parameters.



Diagnostic LED:

Patented two color long-life LED to ensure correct initial installation and to assist in diagnostics on future service calls.



USB connection:

Patented access for wholesalers or installing contractors to review pump history.



Digital sensor:

Unique digital water level sensor with no moving parts to get stuck or clogged.



Universal application:

Widest application range for exposed mount pumps in the market from 6,000 Btu/H to 120,000 Btu/H (1.75kW to 35kW).



Integrated replaceable 10 A fuse:

Factory installed replaceable 5 x 20 mm 10A fuse.

The all new Gobi II condensate pump has been completely redesigned retaining all the good features you like and upgrading everything else. The Gobi II has a massive flow range allowing its use from 6,000 Btu/H (1.75kW) up to 120,000 Btu/H (35 kW). Its digital water sensor, universal voltage and user configurable flow ensure it is the strongest, quietest under A/C mounted condensate pump on the market today.



Technical information

- Maximum flow rate: 11 GPH
- Maximum suction: 10 ft. self priming
- Maximum head: 65.60 ft.
- Maximum horizontal run: 330 ft. at 0 head and 0 suction
- Sound: 20dBA at 1 m running (19dBa at 1 m DIN EN ISO 3741:2011 / DIN EN ISO 3744:2010)
- Voltage: 100 ~ 240 VAC 50/60 Hz auto sensing universal power input
- Power: 12 watts during maximum operation at 110v
- Alarm relay: 10 Amps NO/NC contacts with integrated replacable 10A fuse 5 x 20 mm
- Weight: 1.3 Lbs.
- Discharge star tube: 1/4" I.D. x 3.3 ft.
- Protection: Class II double insulation, Fully potted, IP-44
- Ambient and water: 41 °F to 104 °F

Part No 3004045

Capacity

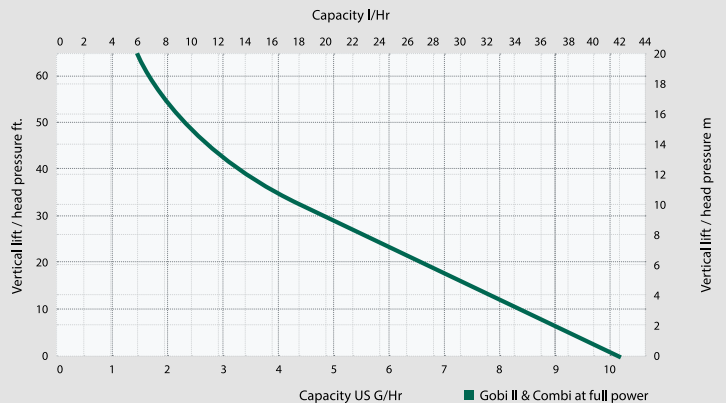



Gobi II kit includes

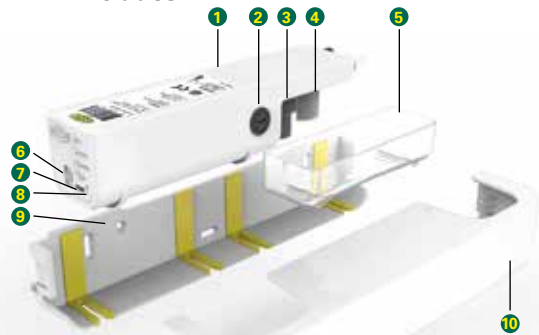

- 1 Pump body
- 2 Factory-installed fuse
- 3 Replaceable filter
- 4 Digital sensor
- 5 Water tray
- 6 Dip-switches
- 7 USB port
- 8 Diagnostic LED
- 9 Wall back plate
- 10 Cover

Provided accessories



Power cable



Alarm cable



Screws



Star tube and stop siphon device



Factory-installed fuse



Screw anchors (red)



Cable ties

Dimensions pump



Application

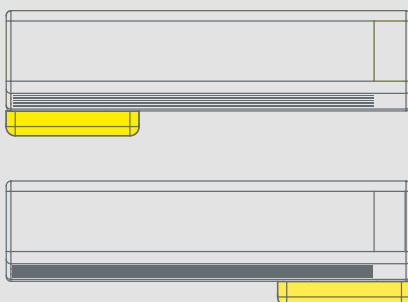

Gobi II pump can be mounted on the right or on the left side.

Replacement parts

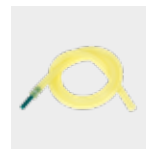

KIT-4087
Star tube with Stop-Siphon Device
Part No 3004087



FIL-4064/4
Filter, 4 pcs.
Part No 3004064



FUS-4050/10
Fuses 5x20 10A, 10 pcs.
Part No 3004050



HSG-4065/4
Stop-Siphon Device, 4 pcs.
Part No 3004065

KAROO



The KAROO drain pan pump is a submersible condensate removal pump designed to automatically remove condensate water from refrigerated cases, dehumidifiers, fan coils and air conditioning systems. The pump is intended to be installed within a collection tray inside the equipment. The water level is measured by an Electronic Energy Control System (EECS™) that controls the operation of the pump via the fully-encapsulated circuitry.

Technical information

- Electronic Energy Control System (EECS™) with alarm circuit
- Soft start with EECS™
- All electrical components safely encapsulated against moisture ingress
- Submersible
- Amazingly quiet
- Powerful and compact
- Filter and non-return valves built in
- No mechanical floats to stick
- CE and UL approved

Power supply: 120/240 V, 50/60 Hz Auto sensing
Power consumption: 16 W max., 0.25 when idle
Alarm relay: 5 A, 30 VDC, 250 VAC Break on fault
Capacity: 3.17 US gal/h
Discharge head: >65 ft vertical, >328 ft horizontal
3.28 ft suction
Ambient temp: 32° F to 104° F
Material: Flame retardant ABS - UL94 5 VA
Discharge tube: 1/4" ID
Dimensions: 6.3" x 1.7" x 1.3"

Part No: 4678512

Capacity

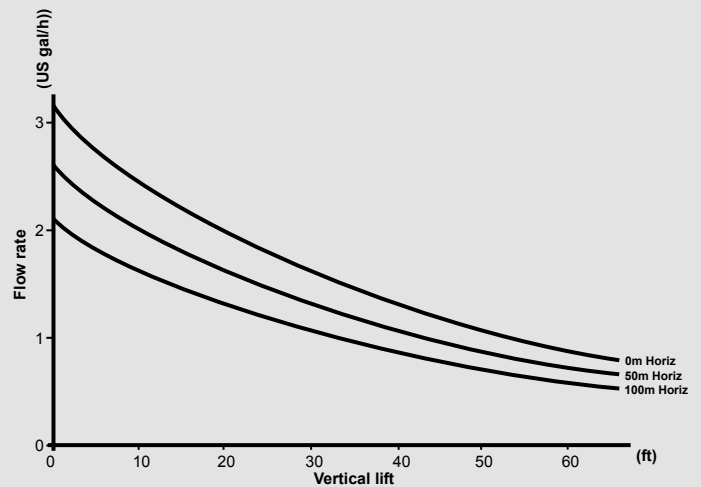

AquaSwitch

Inverter Check Kit



The AQUASWITCH is an electronic Water Switch for valves, pumps and alarms.

The AQUASWITCH is a small controller with a sensitive electronic circuit encapsulated inside. Constructed for all applications where a reliable switch is needed to control or indicate the presence of water.

Technical information

- Electronic switch
- Water detection with accurate switching level
- AquaSensor electronic water detector has no moving parts and non-contact sensing
- All components totally encapsulated for safety against moisture ingress
- High reliability
- Small enough to be used in restricted spaces

| | |
|----------------------------------|---|
| Voltage: | 24 V AC/DC |
| Max. switched relay current: | 5 A |
| Relay switch-off delay: | 2.5 +/- 0.5 seconds |
| Ambient temperature range: | 32° F - 167° F |
| Water Level for Switching Relay: | 1/8" +/- 1/5" (depends on water quality) |
| Cable Length: | 20" |

Part No: 4679152



The INVERTER CHECK KIT is an invaluable tool for the analysis of problems with inverted-fed air conditioners. Designed to be used both in installation and maintenance, this kit can indicate correctly-operating inverter power stages, as well as the serial-link communication between the condensing unit and the indoor units. This allows the air conditioning engineer to easily identify faults and reduces the time required for analysis and repair. The kit contains the electronic module with a set of leads for testing the serial communications links, as well as a selection of cables and connectors for the power output terminals of the inverter.

Technical information

- Suitable for all sizes and manufacturer's air conditioners
- Crocodile clips, hook connectors and cable sets provided
- Shows up damage to Inverter Output Stage
- Identifies pc-board or wiring faults on Data Link Circuits
- LED indicators show correct operation

Dimension: 3.19" x 2.88" x 1.10" (LxWxH)

Part No: 4678571

**HVAC/R
Service Products**



World Headquarters:
REFCO Manufacturing Ltd.
Industriestrasse 11
CH-6285 Hitzkirch (Switzerland)

Phone: 011 41 41 919 72 82
Fax: 011 41 41 919 72 83

info@refco.ch
www.refco.ch

North American Headquarters:
REFCO Manufacturing (US) INC.
66 B Industry Avenue
Springfield MA 01104

Phone: 413 739 4761
Fax: 413 733 9267

sales@refcoswiss.com
www.refcoswiss.com
www.refco.com

**24/7 customer service:
1 800 848 4232**

REFCO®
REFCO is a registered trademark
in various countries. Patent Pending.
© Copyright 2016 by REFCO Manufacturing Ltd.
Switzerland - all rights reserved.
More information: visit www.refco.ch

www.condensate-pumps.com