

Universal Condensate Pump

HVAC/R
Service Products



Integrated replaceable
10 A fuse
Factory-installed replaceable
5 × 20mm 10 A fuse



Universal application
6,000 Btu/H up to
120,000 Btu/H
(100–240 VAC)



Digital sensor
Unique digital water
level sensor

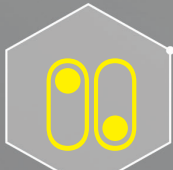

Quiet mode
Configure pump performance
to AC unit capacity

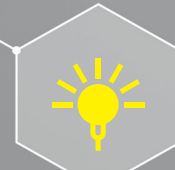

Diagnostic LED
Ensures correct
initial installation and
assists in diagnostics

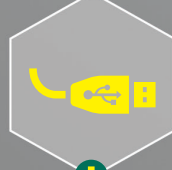

USB connection
View operational pump history



The multi-feature powerhouse

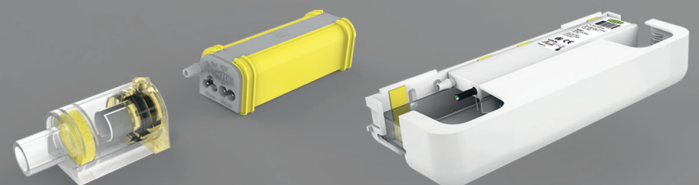

www.condensate-pumps.com

Combi

Gobi II

6

new reasons why you should choose a REFCO pump



Quiet mode:

Installer configurable pump performance using dip-switches to optimize each individual installation for the best performance and sound parameters.



Diagnostic LED:

Patented two color long-life LED to ensure correct initial installation and to assist in diagnostics on future service calls.



USB connection:

Patented access for wholesalers or installing contractors to review pump history.



Digital sensor:

Unique digital water level sensor with no moving parts to get stuck or clogged.



Universal application:

Widest application range for interior/exterior mount pumps in the market from 6,000 Btu/H to 120,000 Btu/H (1.75kW to 35kW).



Integrated replaceable 10 A fuse:

Factory installed replaceable 5 × 20mm 10A fuse.

9 more reasons to choose REFCO



Optional Wireless access:

Wireless connection with a smart-phone to check and diagnose hard to access pumps.



10 AMP alarm:

Patented integrated 10A replaceable fuse for NO or NC alarm circuit protection.



Universal voltage:

Power input from 100 to 240 VAC 50/60 Hz for single part number world wide applications.



Soft start:

This pump has over 40 speeds and will always begin softly to improve electrical efficiency and to minimize customer noise complaints.



Wet start:

Patented dual slope condensate tray to prevent noisy dry pump operation and to trap damaging foreign debris away from pump filter.



Silent run:

Quietest condensate pumps on the market with less than 20dBA at 1m. (19dBA at 1m according to DIN EN ISO 3741:2011 / DIN EN ISO 3744:2010).)



Star tube:

Patented pulsation isolating discharge tube to prevent contact vibration noise.



Stop siphon:

Integrated connection device to assist with challenging condensate drain line installations.



Check valve:

Built-in one way non-return valve to prevent water backflow through pump.

The all new Gobi II condensate pump has been completely redesigned retaining all the good features you like and upgrading everything else. The Gobi II has a massive flow range allowing its use from 6,000 Btu/H (1.75kW) up to 120,000 Btu/H (35 kW). Its digital water sensor, universal voltage and user configurable flow ensure it is the strongest, quietest under A/C mounted condensate pump on the market today.

The Combi condensate pump is an entirely new design specifically manufactured for use in duct-free air conditioning split systems. The Combi is full of custom features that are unique to the world market. The flow range, optional configuration and universal voltage allow both installing contractors and wholesalers to stock and use a single product that fulfills all your requirements.

Gobi II

Part # 3004045



Application

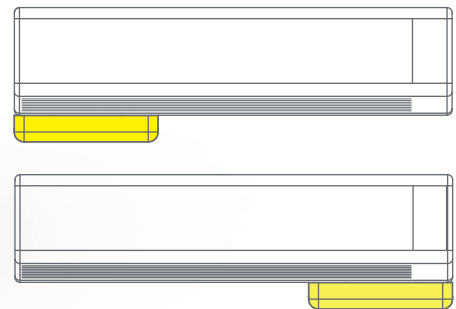

Gobi II pump can be mounted on the right or on the left side

Combi

Part # 3004046

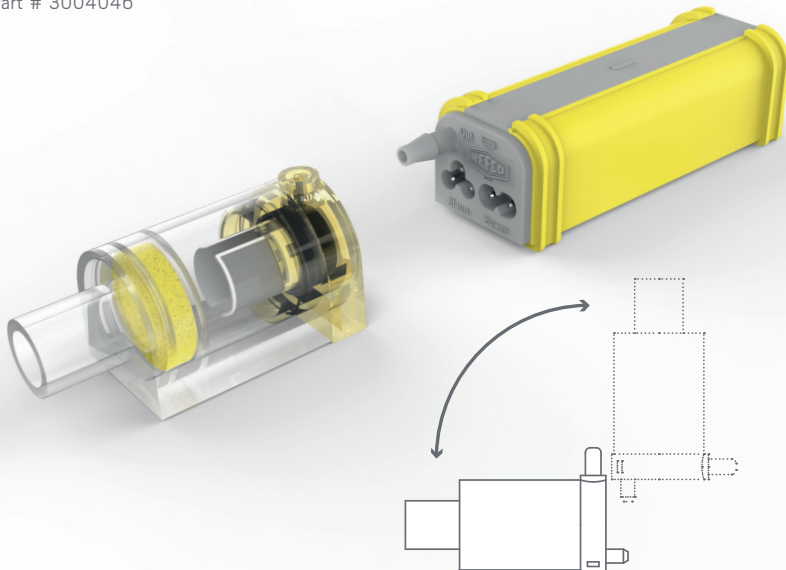

Water sensor can be used horizontally or vertically.

Application

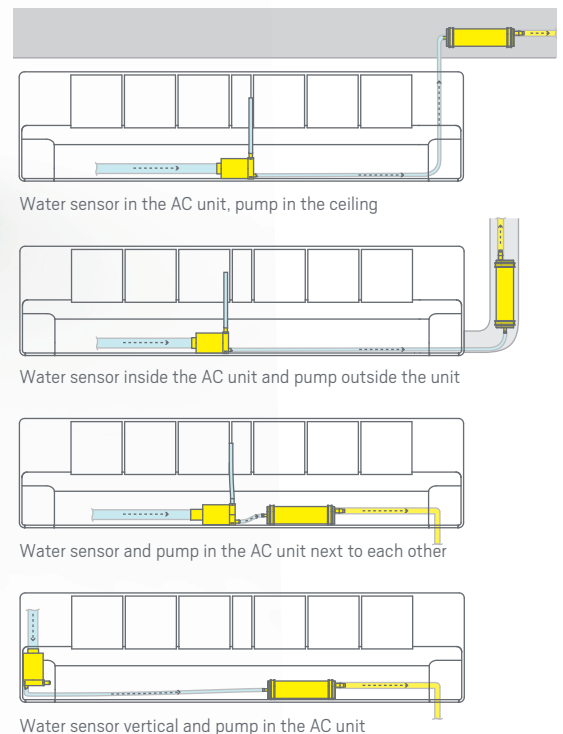

Water sensor in the AC unit, pump in the ceiling

Water sensor inside the AC unit and pump outside the unit

Water sensor and pump in the AC unit next to each other

Water sensor vertical and pump in the AC unit

Technical information Gobi II and Combi

Maximum flow rate:	11 GPH (42 l/Hr.)
Maximum suction:	10 ft. (3 m) self priming
Maximum head:	65.60 ft. (20 m)
Maximum horizontal run:	330 ft. (100 m) at 0 head and 0 suction
Sound:	20dBA at 1m running (19dBA at 1 m DIN EN ISO 3741:2011 / DIN EN ISO 3744:2010)
Voltage:	100 ~ 240 VAC 50/60 Hz auto sensing universal power input
Power:	8 watts during maximum operation at 110v
Alarm relay:	10 Amps NO/NC contacts with integrated replaceable 10A fuse 5 × 20 mm
Weight:	Gobi II: 1.3 Lbs. (600 g), Combi: 0.63 Lbs. (285 g)
Discharge star tube:	1/4" I.D. (6.25 mm) × 3.3 ft. (1 m)
Packaging:	9.9 x 13.4 x 2.1 inches (250 x 340 x 54 mm)
Bulk pack:	10 Pcs dimensions are 23.2 x 10.4 x 14.4 inches (590 x 265 x 365 mm)
Color:	Gobi II: RAL #9003 white, Combi: RAL #7040 Grey and RAL #1023 Yellow
Protection:	Class II double insulation, Fully potted, IP-44
Operation temp:	Ambient 37.5°F to 104°F (3°C to 40°C) / Water 41°F to 77°F (5°C to 25°C)
Compliance:	Conforms to UL:778 and certified to CSA C22.2 #68



Capacity

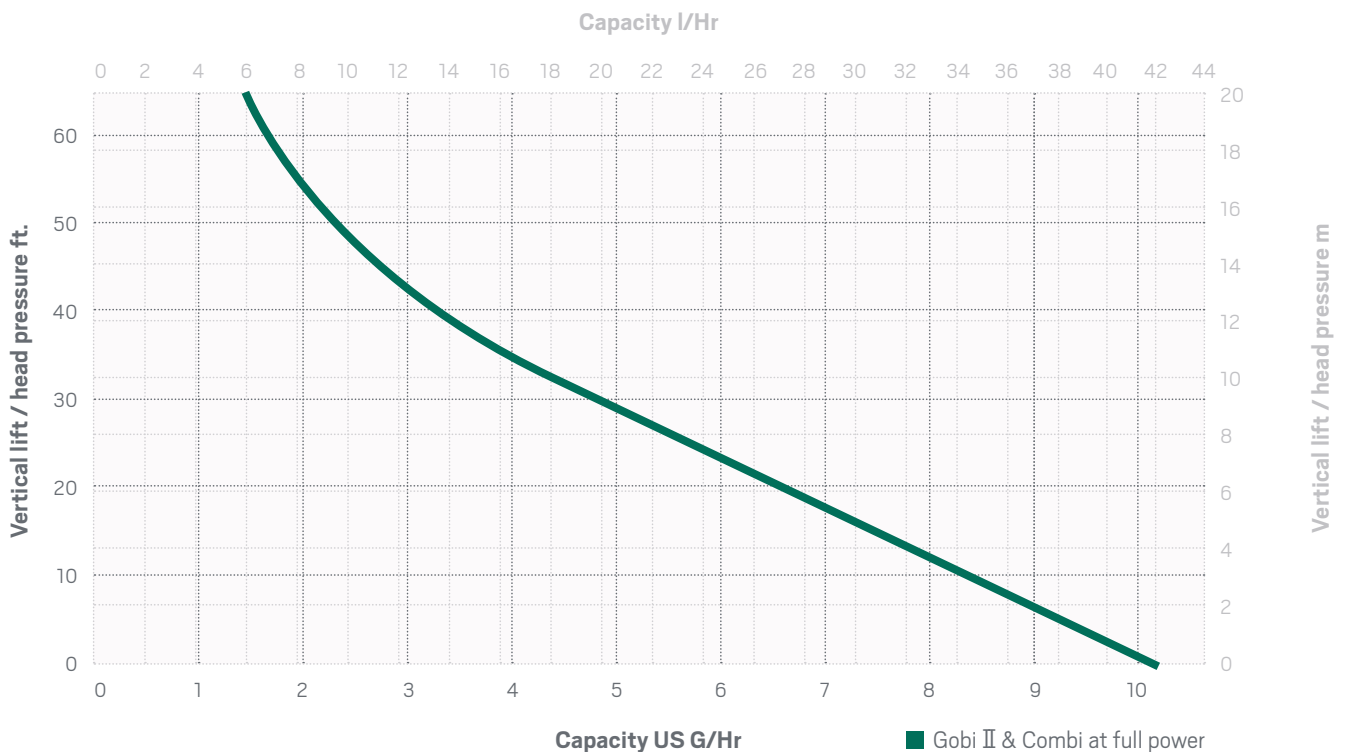

Gobi II kit includes

Provided accessories

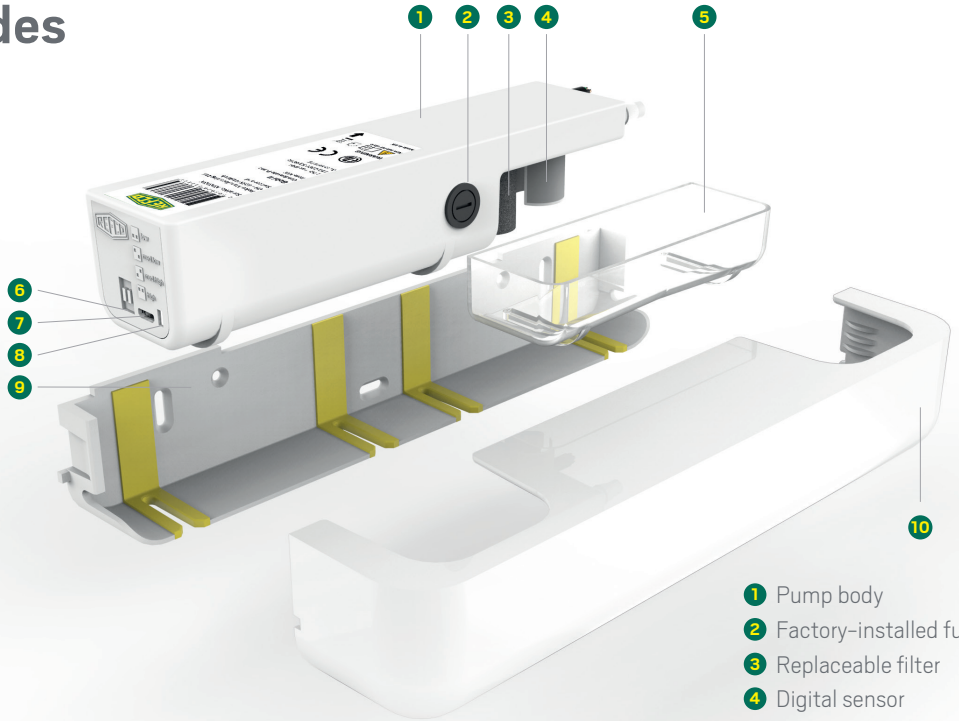
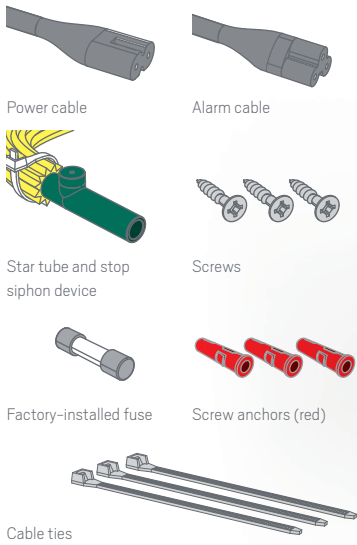

- 1 Pump body
- 2 Factory-installed fuse
- 3 Replaceable filter
- 4 Digital sensor
- 5 Water tray
- 6 Dip-switches
- 7 USB port
- 8 Diagnostic LED
- 9 Wall back plate
- 10 Cover

Dimensions pump

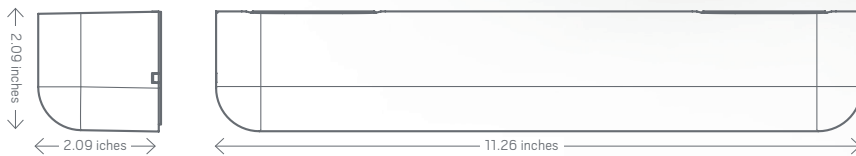

Combi kit includes

Provided accessories

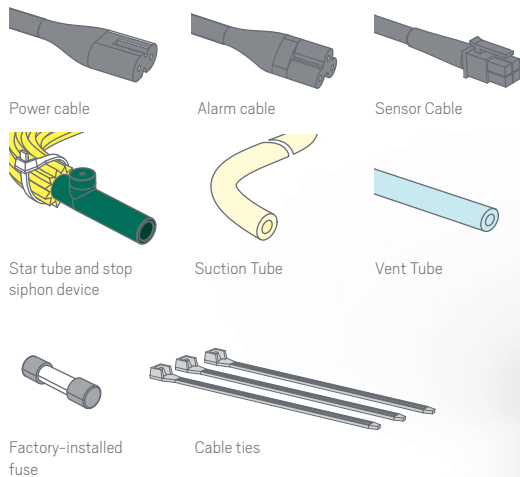

- 1 Diagnostic LED
- 2 USB port
- 3 Dip-switches
- 4 Water sensor plug
- 5 Pump body
- 6 Factory-installed fuse
- 7 Digital sensor
- 8 Replacable filter
- 9 Water sensor

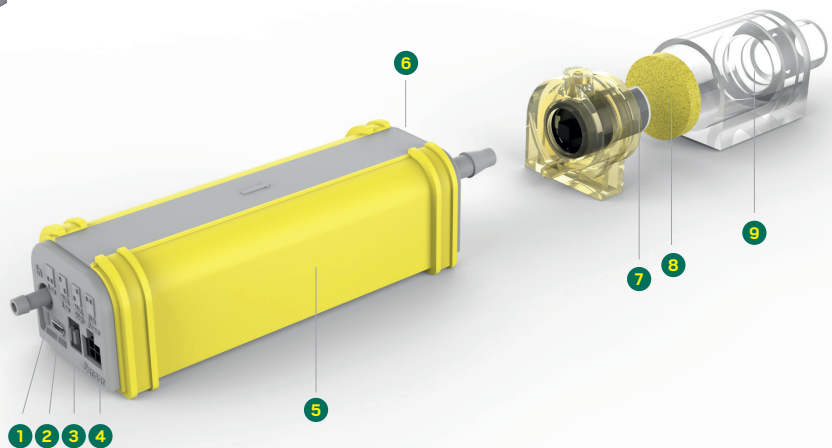

Dimensions pump



Dimensions water sensor

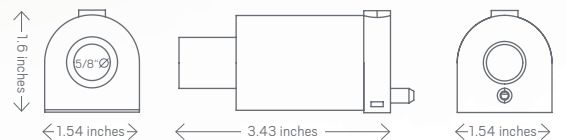

**HVAC/R
Service Products**



North America Headquarters:

REFCO Manufacturing (US) Inc.

66 B Industry Avenue
Springfield MA 01104

Phone: 413 739 4761

Fax: 413 733 9267

sales@refcoswiss.com

www.refcoswiss.com

24/7 customer service: 1 800 848 4232

www.condensate-pumps.com

REFCO®

REFCO is a registered trademark in various countries. Patent Pending.

© Copyright 2016 by REFCO Manufacturing Ltd. Switzerland – all rights reserved.

More information: visit www.refco.ch