



Refrigeration Research, Inc.

For More Than One Half Century



2017

Innovation



Quality



Service

Refrigeration
Parts and Equipment Catalog

INDEX

2017 Catalog

ACCUMULATORS	27
ACCUMULATOR - DRIERS	27
CAPILLARY ASSEMBLIES	
Strainer	30
Strainer-Drier	29
CONDENSERS (WATER COOLED)	
Coaxial	19
Shell & Coil	18
DRIERS	
Big R	28
Junior	29
Filter	25
Universal	28
FITTINGS (Rotalock)	14, 15, 16, 17
FUSIBLE PLUGS	7
HEAT EXCHANGERS	
Blue Ribbon (Subcooling)	21
Deluxe (Subcooling)	21
Desuperheating	20
Double Wall Cleanable Desuperheating	19
Liquid to Liquid	22
Shell & Coil Type Condensers	18
HEAT PUMP	
Suction Accumulators	6, 7
Water Cooled Condensers	18, 19
MANIFOLDS	27
MUFFLERS (Discharge)	
Adjustable	10
Higher Pressure	11
Non-Adjustable	10

MUFFLERS (Suction)	11
OIL RESERVOIRS	22
OIL SEPARATORS	23
OIL SEPARATORS FOR 410A	23
OIL STRAINERS	22
RECEIVERS	
ASME	15
R410A ASME	17
Conventional	12, 13
For Rotalock Fittings	14, 15, 16, 17, 18
Higher Pressure	16
Big Dog Receiver Driers	18
SIGHT GLASSES	12
SPECIAL O.E.M. PARTS	24
STRAINERS	
Capillary	31
Liquid Line	26
Water	26
Strainer Elements	31
Cartridge or Pencil	31
SUCTION ACCUMULATORS	
Heat Pump	6, 7
Commercial	2, 3
No Sweat-No Frost	9
ASME 410A	8
SUCTION ACCUMULATOR HEAT EXCHANGER	
COMBINATIONS	4, 5
TUBING	
Capillary	30
VALVES (Rotalock)	14, 15, 16, 17

• Research • Design • Quality • Value • Service • Experience •

Engineering departments look to Refrigeration Research for assistance in design of component parts and procurement of test samples. We always strive to improve quality and reduce cost through engineering and manufacturing advancements. Contact us for your special needs or assistance.



REFRIGERATION RESEARCH INC.

525 North Fifth Street • P.O. Box 869
Brighton, Michigan 48116

Phone: (810) 227-1151

FAX: (810) 227-3700

WEBSITE: www.refresearch.com



Pointing the Way WITH NEW IDEAS

SUCTION ACCUMULATOR APPLICATION DATA

PART NUMBER	VERTICAL OR HORIZONTAL	DIAMETER (INCHES)	# LENGTH	WEIGHT	MAXIMUM REFRIGERANT HOLDING CAPACITY (LBS.)				UL CODE IDENT	SUCTION INLET/ OUTLET I.D. SIZE	EVAP TEMP	† RECOMMENDED TONS OF REFRIGERATION							
					R-410A	R-134a	R-22	R-404a				REFRIGERANT							
												MAX	MIN	MAX	MIN	MAX	MIN	MAX	MIN
3680	V	3.0	8.2	2.3	1.3	1.5	1.5	1.3	HN	1/2	+40°F	0.94	0.17	0.45	0.11	0.90	0.16	0.80	0.13
3816	V	4.0	7.1	3.0	1.9	2.2	2.1	1.9	KN		+20°F	0.65	0.15	0.31	0.09	0.62	0.14	0.58	0.10
3817	V	4.0	11.1	4.6	3.7	4.2	4.2	3.7	KN		0°F	0.47	0.11	0.22	0.08	0.45	0.11	0.40	0.08
3815	H	3.0	7.9	2.1	1.3	1.5	1.5	1.4	HN		-20°F	0.31	0.09	0.13	0.06	0.30	0.09	0.25	0.06
3673	H	3.0	10.9	2.7	2.0	2.2	2.2	1.9	HN		-40°F	0.19	0.07	0.08	0.04	0.18	0.07	0.14	0.05
3684	V	3.0	8.3	2.2	1.4	1.6	1.6	1.4	HN	5/8	+40°F	2.10	0.19	0.90	0.13	2.00	0.18	1.55	0.15
3701	V	4.0	7.1	3.0	1.9	2.2	2.1	1.9	KN		+20°F	1.31	0.17	0.54	0.11	1.25	0.16	1.00	0.12
3689	V	3.0	10.8	2.8	1.9	2.2	2.2	1.9	HN		0°F	0.89	0.13	0.36	0.10	0.85	0.13	0.70	0.10
3685	V	3.0	12.6	3.1	2.4	2.7	2.7	2.4	HN		-20°F	0.58	0.11	0.22	0.08	0.55	0.11	0.45	0.08
3702	V	4.0	11.1	4.6	3.6	4.2	4.1	3.6	KN		-40°F	0.36	0.09	0.13	0.06	0.35	0.09	0.25	0.07
3820	H	3.0	7.9	2.4	0.8	1.5	1.5	1.4	HN	3/4	+40°F	3.15	0.23	1.62	0.14	3.0	0.22	2.8	0.22
3703	V	4.0	11.4	5.2	3.5	4.1	4.0	3.7	KN		+20°F	2.21	0.19	1.03	0.11	2.1	0.18	2.0	0.18
3731	V	5.0	10.2	6.0	5.5	6.2	6.1	5.3	DN		0°F	1.57	0.17	0.63	0.10	1.5	0.16	1.4	0.16
3733	V	5.0	12.7	7.7	6.9	8.0	7.9	6.9	DN		-20°F	1.15	0.13	0.43	0.09	1.1	0.13	0.8	0.13
											-40°F	0.60	0.10	0.25	0.06	0.6	0.10	0.5	0.10
3670	V	4.0	11.3	5.2	3.5	4.0	4.0	3.5	KN	7/8	+40°F	4.20	0.55	2.25	0.35	4.0	0.53	4.0	0.53
3732	V	5.0	10.5	6.0	5.5	6.2	6.1	5.3	DN		+20°F	3.15	0.47	1.62	0.30	3.0	0.45	3.0	0.45
3738	V	5.0	13.2	7.7	7.0	8.0	7.9	6.9	DN		0°F	2.41	0.41	0.87	0.25	2.3	0.39	2.0	0.39
3734	V	5.0	14.8	8.7	8.0	9.0	8.9	7.8	DN		-20°F	1.57	0.34	0.63	0.20	1.5	0.33	1.3	0.33
3710	V	5.0	18.0	11.0	9.0	10.2	10.1	8.8	DN		-40°F	0.94	0.28	0.36	0.16	0.9	0.27	0.7	0.27
3827	V	6.0	14.0	11.3	10.0	11.3	11.1	9.8	MN	1-1/8	+40°F	9.45	0.80	4.35	0.48	9.0	0.76	9.0	0.53
3825	H	6.0	10.0	8.9	8.5	9.7	9.6	8.4	MN		+20°F	6.51	0.68	2.88	0.43	6.2	0.65	6.0	0.45
3826	H	6.0	13.5	12.0	11.7	13.3	13.1	11.6	MN		0°F	4.51	0.59	1.83	0.36	4.3	0.56	4.0	0.39
3832	V	6.0	11.0	10.0	7.6	8.6	8.5	7.5	MN		-20°F	2.94	0.49	1.21	0.29	2.8	0.47	2.5	0.33
3735	V	5.0	15.6	8.7	8.0	9.0	8.9	7.8	DN		-40°F	1.89	0.39	0.78	0.15	1.8	0.38	1.4	0.27
3736	V	5.0	19.1	10.5	10.1	11.3	11.1	9.8	DN	1-3/8	+40°F	17.80	2.10	7.20	1.35	17.0	2.0	15.0	0.76
3700	V	6.0	15.0	13.0	11.5	13.1	12.9	11.4	MN		+20°F	11.50	2.00	5.40	1.16	11.0	1.9	10.0	0.65
3707	V	6.0	18.1	14.5	14.4	16.3	16.1	14.2	MN		0°F	8.08	1.68	3.42	0.97	7.7	1.6	7.0	0.56
3830	H	6.0	13.5	11.3	13.2	15.0	14.8	13.0	MN		-20°F	5.25	1.36	2.16	0.87	5.0	1.3	4.5	0.47
3831	H	6.0	16.5	13.2	16.0	18.1	17.9	15.7	MN		-40°F	3.15	1.15	1.26	0.68	3.0	1.1	2.5	0.38
3837	V	5.0	13.5	11.8	9.4	10.7	10.6	9.3	MN	1-5/8	+40°F	29.40	2.10	11.70	1.35	28.0	2.0	25.0	2.0
3737	V	5.0	18.5	10.5	10.1	11.3	11.1	9.8	DN		+20°F	19.90	2.00	8.10	1.16	19.0	1.9	18.0	1.9
3708	V	6.0	15.0	13.0	11.5	13.1	12.9	11.4	MN		0°F	13.60	1.68	5.40	0.97	13.0	1.6	12.0	1.6
3706	V	6.0	20.3	17.0	15.6	17.8	17.5	15.4	MN		-20°F	8.40	1.36	3.60	0.87	8.0	1.3	7.0	1.3
3743	V	6.0	24.8	18.0	20.1	22.9	22.6	19.9	MN		-40°F	5.25	1.15	1.80	0.68	5.0	1.1	4.0	1.1
3835	H	6.0	13.5	11.5	13.2	15.0	14.8	13.0	MN	2-1/8	+40°F	61.90	5.09	28.8	3.57	59.0	5.8	55.0	5.8
3836	H	6.0	22.5	17.1	15.2	17.3	17.1	15.1	MN		+20°F	43.00	5.46	18.9	3.09	41.0	5.2	39.0	5.2
3698	V	6.0	17.1	14.4	12.6	14.4	14.2	12.5	MN		0°F	28.30	4.51	12.6	2.51	27.0	4.3	26.0	4.3
3704	V	6.0	24.8	20.5	20.1	22.9	22.6	19.9	MN		-20°F	18.50	3.88	7.2	2.03	18.0	3.7	16.0	3.7
3809	H	6.0	18.0	15.6	11.3	12.9	12.7	11.2	MN		-40°F	12.60	2.83	4.5	1.64	12.0	2.7	10.0	2.7
3810	H	6.0	30.0	22.0	19.0	21.6	21.3	18.8	MN	2-5/8	+40°F	Δ	Δ	45.0	5.70	90.0	9.5	85.0	9.5
3639	V	8-5/8	20.0	44.0	Δ	31.3	30.9	27.2	*		+20°F	Δ	Δ	29.7	5.02	62.0	8.4	60.0	8.4
3838	H	6.0	36.0	28.0	27.5	31.3	30.9	27.2	MN		0°F	Δ	Δ	19.8	4.06	42.0	7.0	40.0	7.0
3839	H	6.0	48.0	35.5	36.8	41.3	41.0	36.4	MN		-20°F	Δ	Δ	11.7	3.28	28.0	6.0	25.0	6.0
											-40°F	Δ	Δ	7.2	2.70	18.0	4.2	15.0	4.2
3641	V	10-3/4	20.0	57.0	Δ	51.4	50.7	44.7	*	3-1/8	+40°F	Δ	Δ	63.0	9.66	130.0	15.0	125.0	15.0
3841	H	8-5/8	24.0	48.0	Δ	45.2	44.6	39.3	*		+20°F	Δ	Δ	48.6	8.40	90.0	13.0	90.0	13.0
											0°F	Δ	Δ	33.3	6.57	60.0	11.0	60.0	11.0
											-20°F	Δ	Δ	20.7	5.89	40.0	9.3	40.0	9.3
3640	V	10-3/4	26.0	75.0	Δ	72.7	72.5	63.9	*		-40°F	Δ	Δ	11.7	4.64	28.0	7.5	25.0	4.5
3840	H	10-3/4	24.0	63.0	Δ	71.3	70.4	62.0	*										
3873	H	10-3/4	48.0	114	Δ	151.5	149.5	131.7	*										
3874	H	10-3/4	60.0	120	Δ	191.6	189.1	166.5	*										

Suction Accumulators of 6" diameter or smaller are  and  LISTED File No. SA2400 (Hydrogen copper brazed construction)

Suction Accumulators larger than 6" diameter are made to ASME Code. (Shielded arc welded construction) ASME # Length in inches includes nipples

† Maximum and minimum recommended tons based on pressure drop and oil return through Suction Accumulators.

‡ Minimum recommended tons based on oil return through Suction Accumulators.

Δ These ASME models are not intended for use with R-410A refrigerant. See alternate line for R-410A ASME Models.

• Electric float not available on HX models.

• Suction Accumulators rated for 450 PSI (UL); 350 PSI (ASME)





Designed to do the Complete Job!

HEAT EXCHANGER— SUCTION ACCUMULATOR

Makes practical new design possibilities in refrigeration systems.

Development of the Heat Exchanger-Suction Accumulator as a refrigeration component by Refrigeration Research has resulted in new and practical designs and design possibilities in refrigeration systems.

As the result of the rapidly growing need, Refrigeration Research provides a Cataloged Heat Exchanger-Suction Accumulator to correspond to each of our most popular suction accumulators. The Heat Exchanger-Suction Accumulator combinations bear the same part number as the corresponding suction accumulators except that the letters HX have been added to indicate the presence of the heat exchanger coil. Other models are available on special order.

All Heat Exchanger-Suction Accumulators are complete with fusible plugs installed complying with latest  and  requirements, except those built to ASME code. CE documentation available upon request.

Copper nipples are standard on vertical  and  models. Steel nipples are standard on accumulators built to ASME code.

Steel nipples are available on vertical  and  models on special order.

Application data is shown on the next page.



HX3701
HX3702
HX3703
HX3738



HX3836
HX3810
HX3839

ASME CODE MODELS

HX3639
HX3641
HX3640



ASME CODE MODELS

HX3841
HX3840

Mounting Brackets
RR 7187 (8 5/8" Dia.)
RR 7188 (10 3/4" Dia.)

These brackets can be used to hold horizontal accumulators securely in position.

MADE UNDER ONE OR MORE OF THE FOLLOWING PATENTS;
NOS. 5,076,313; 5,075,967; 4,488,413; AND PATENTS APPLIED FOR.



(SUCTION ACCUMULATORS ESPECIALLY DESIGNED FOR HEAT PUMPS ARE SHOWN ON PAGES 6 AND 7).
PHOTOS FOR ILLUSTRATIVE PURPOSE ONLY - DO NOT USE AS A GUIDE FOR INSTALLATION.



APPLICATION DATA FOR HEAT EXCHANGER-SUCTION ACCUMULATOR COMBINATIONS

Suction Accumulators on this page are exactly the same as the corresponding numbers on page 3 except that "HX" designates a Heat Exchanger Coil added.

PART NUMBER	VERTICAL OR HORIZONTAL	DIAMETER (INCHES)	# LENGTH	WEIGHT	MAXIMUM REFRIGERANT HOLDING CAPACITY (LBS.)				UL ID	SUCTION LINE I.D.	LIQUID LINE I.D.	EVAP TEMP	† RECOMMENDED TONS OF REFRIGERATION									
					REFRIGERANT								R-410A		R-134a		R-22		R-404a			
					R-410A	R-134a	R-22	R-404a					MAX	MIN	MAX	MIN	MAX	MIN	MAX	MIN		
HX3701	V	4	7-1/8	3.0	1.9	2.2	2.1	1.9	KN	5/8	3/8	+40°F	2.10	0.19	0.90	0.13	2.00	0.18	1.55	0.15		
														+20°F	1.31	0.17	0.54	0.11	1.25	0.16	1.00	0.12
HX3702	V	4	11-1/8	5.5	3.6	4.2	4.0	3.6	KN					0°F	0.89	0.13	0.36	0.10	0.85	0.13	0.70	0.10
														-20°F	0.58	0.11	0.22	0.08	0.55	0.11	0.45	0.08
													-40°F	0.36	0.09	0.13	0.06	0.35	0.90	0.25	0.07	
										3/4	3/8	+40°F	3.15	0.23	1.62	0.14	3.0	0.22	2.8	0.22		
														+20°F	2.21	0.19	1.03	0.11	2.1	0.18	2.0	0.18
HX3703	V	4	11-3/8	5.6	3.5	4.1	4.0	3.7	KN					0°F	1.57	0.17	0.63	0.10	1.5	0.16	1.4	0.15
														-20°F	1.15	0.13	0.43	0.09	1.1	0.13	0.8	0.13
													-40°F	0.60	0.10	0.25	0.06	0.6	0.10	0.5	0.10	
										7/8	1/2	+40°F	4.20	0.55	2.25	0.35	4.0	0.53	4.0	0.54		
														+20°F	3.15	0.47	1.62	0.30	3.0	0.45	3.0	0.45
HX3738	V	5	13	9.0	7.0	8.0	7.9	6.9	EN					0°F	2.41	0.41	0.87	0.25	2.0	0.39	2.0	0.39
														-20°F	1.57	0.34	0.63	0.20	1.5	0.33	1.3	0.33
													-40°F	0.94	0.28	0.36	0.16	0.9	0.27	0.7	0.27	
										1 1/8	5/8	+40°F	9.45	0.80	4.35	0.48	8.0	0.76	9.0	0.76		
														+20°F	6.51	0.68	2.88	0.43	6.2	0.65	6.0	0.65
HX3700	V	6	15	15.0	11.5	13.1	12.9	11.4	MN					0°F	4.51	0.59	1.83	0.36	4.3	0.56	4.0	0.56
														-20°F	2.94	0.49	1.21	0.29	2.8	0.47	2.5	0.47
													-40°F	1.89	0.39	0.78	0.15	1.8	0.38	1.4	0.38	
										1 3/8	5/8	+40°F	17.8	2.10	7.20	1.35	17.0	2.00	15.0	2.00		
														+20°F	11.5	2.00	5.40	1.16	11.0	1.90	10.0	1.90
HX3706	V	6	20-1/4	20.5	15.6	17.8	17.5	15.4	MN					0°F	8.08	1.68	3.42	0.97	7.7	1.60	7.0	1.60
HX3836	H	6	22-1/2	20.0	15.2	17.3	17.1	15.1	MN					-20°F	5.25	1.36	2.16	0.87	5.0	1.30	4.5	1.30
												-40°F	3.15	1.15	1.26	0.68	3.0	1.10	2.5	1.10		
										1 5/8	3/4	+40°F	29.4	2.10	11.7	1.35	28.0	2.00	25.0	2.00		
														+20°F	19.9	2.00	8.1	1.16	19.0	1.9	18.0	1.90
HX3704	V	6	24-3/4	27.0	20.1	22.9	22.6	19.9	MN					0°F	13.6	1.68	5.4	0.97	13.0	1.6	12.0	1.60
HX3810	H	6	30	26.3	19.0	21.6	21.3	18.8	MN					-20°F	8.40	1.36	3.6	0.87	8.0	1.3	7.0	1.30
												-40°F	5.25	1.15	2.8	0.68	5.0	1.1	4.0	1.10		
										2 1/8	7/8	+40°F	61.9	5.09	28.8	3.57	59.0	5.8	55.0	5.8		
														+20°F	43.0	5.46	18.9	3.09	41.0	5.2	49.0	5.2
HX3639	V	8-5/8	20	50.0	Δ	31.3	30.9	27.2	*					0°F	28.3	4.51	12.6	2.51	27.0	4.3	26.0	4.3
HX3839	H	6	48	40.0	36.8	41.3	41.3	36.4	MN					-20°F	18.5	3.88	7.2	2.03	18.0	3.7	16.0	3.7
												-40°F	12.6	2.83	4.5	1.64	12.0	2.7	10.0	2.7		
										2 5/8	1 3/8	+40°F	Δ	Δ	45.0	5.70	90.0	9.5	85.0	9.5		
														+20°F	Δ	Δ	29.7	5.02	62.0	8.4	60.0	8.4
HX3641	V	10-3/4	20	65.0	Δ	51.4	50.7	44.7	*					0°F	Δ	Δ	19.8	4.06	42.0	7.0	40.0	7.0
HX3841	H	8-5/8	24	63.0	Δ	45.2	44.6	39.3	*					-20°F	Δ	Δ	11.7	3.28	28.0	6.0	25.0	6.0
												-40°F	Δ	Δ	7.2	2.70	18.0	4.2	15.0	4.2		
										3 1/8	1 3/8	+40°F	Δ	Δ	63.0	9.66	130	15.0	125	15.0		
														+20°F	Δ	Δ	48.6	8.40	90.0	13.0	90.0	13.0
HX3640	V	10-3/4	26	75.0	Δ	72.7	72.5	63.9	*					0°F	Δ	Δ	33.3	6.57	60.0	11.0	60.0	11.0
HX3840	H	10-3/4	24	68.0	Δ	71.3	70.4	62.0	*					-20°F	Δ	Δ	20.7	5.89	40.0	9.3	40.0	9.3
HX3873	H	10-3/4	48	114	Δ	151.5	149.5	131.7	*			-40°F	Δ	Δ	11.7	4.64	28.0	7.5	25.0	4.5		
HX3874	H	10-3/4	60	120	Δ	191.6	189.1	166.5	*													

Suction Accumulators of 6" diameter or smaller are  and  LISTED File No. SA2400 (Hydrogen copper brazed construction)
 Suction Accumulators larger than 6" diameter are made to ASME Code. (Shielded arc welded construction) ASME # Length in inches includes nipples
 † Maximum and minimum recommended tons based on pressure drop and oil return through Suction Accumulators.
 ‡ Minimum recommended tons based on oil return through Suction Accumulators.
 Δ These ASME models are not intended for use with R-410A refrigerant. See alternate line for R-410A ASME Models.

- Electric float not available on HX models.
- Suction Accumulators rated for 450 PSI (UL); 350 (ASME)



HEAT PUMP SUCTION ACCUMULATORS

Having pioneered the suction accumulator as a protective component, and having made them continuously over a period of 50 years, Refrigeration Research has acquired considerable experience. However, it has always been our recommendation that tests be made by the system manufacturer to check pressure drop, size of orifice and holding capacity of the accumulator for a particular application.

As a result of tests made by our customers as well as by Refrigeration Research, modifications have been made in many cases for heat pump applications. Our inlet deflector tube baffle, smaller metering orifices and protective screens have proven to be a value. In addition, accumulators for heat pumps may usually be designed for less pressure drop.

Many hundreds of thousands of suction accumulators having inlet deflectors, smaller orifices, and protective strainers have been built by Refrigeration Research and are on systems operating successfully in the field.

Seven models of these field proven heat pump type accumulators are offered as catalog items instead of specials.

All accumulators are complete with a fusible plug to comply with Ψ_L and $c\Psi_L$ requirements. CE documentation also available upon request.

In the heat pump system, the suction accumulator must be installed between the compressor and the reversing valve.

Copper nipples are standard on all Ψ_L and $c\Psi_L$ models.

Steel nipples are available on special order.

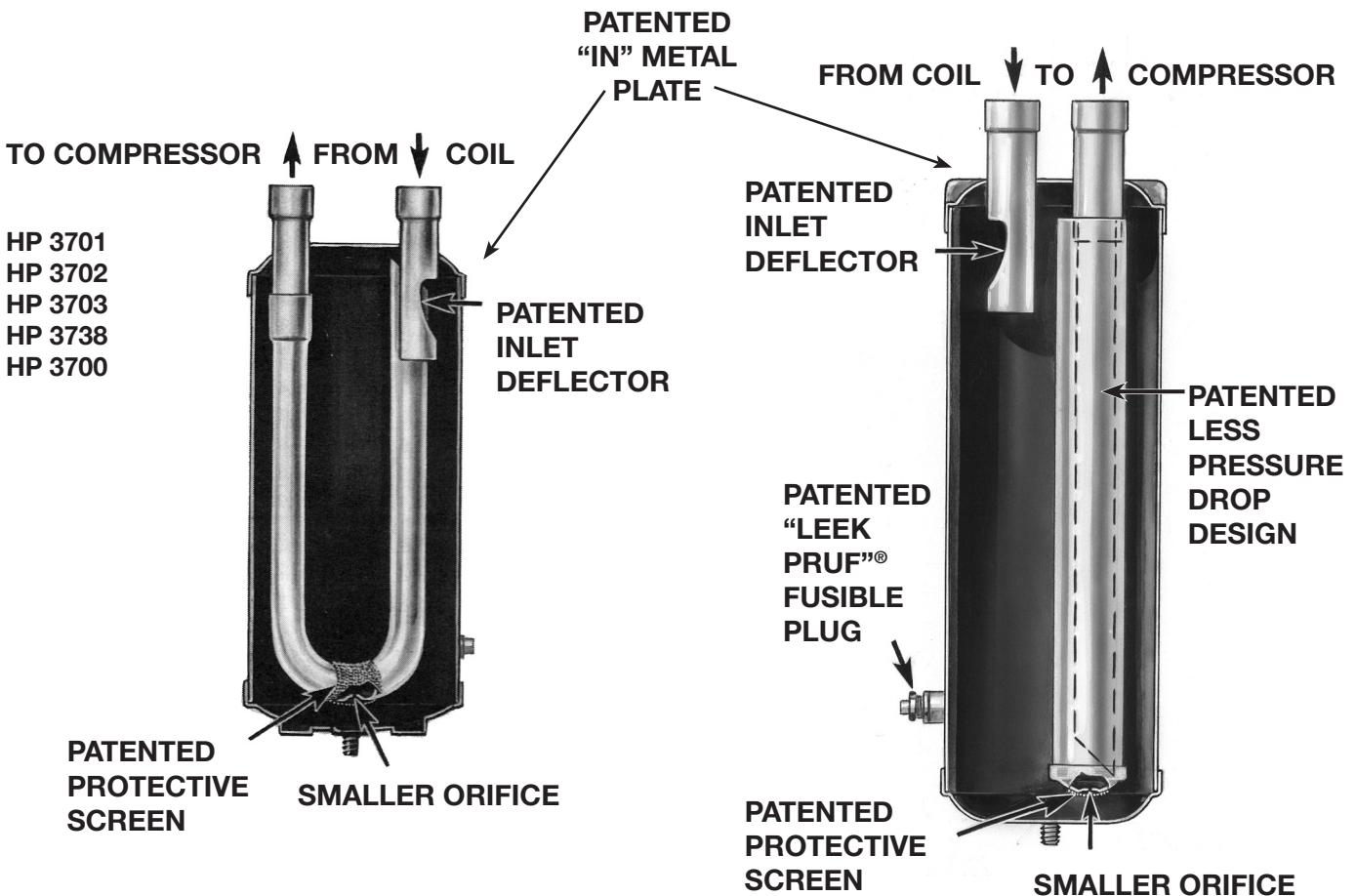

MADE UNDER ONE OR MORE OF THE FOLLOWING PATENTS: NOS.: 5,076,313; 5,075,967; AND PATENTS APPLIED FOR.

PHOTOS FOR ILLUSTRATIVE PURPOSE ONLY - DO NOT USE AS A GUIDE FOR INSTALLATION.



APPLICATION DATA FOR HEAT PUMP SUCTION ACCUMULATORS

PART NUMBER	VERTICAL OR HORIZONTAL	DIAMETER (INCHES)	# LENGTH	WEIGHT	MAXIMUM REFRIGERANT HOLDING CAPACITY (LBS.)				UL ID	SUCTION LINE I.D.	EVAP TEMP	† RECOMMENDED TONS OF REFRIGERATION							
					R-410A	R-134a	R-22	R-404a				REFRIGERANT							
												R-410A		R-134a		R-22		R-404a	
												MAX	MIN	MAX	MIN	MAX	MIN	MAX	MIN
HP3701	V	4	7-1/8	3.0	1.9	2.2	2.1	1.9	KN	5/8	+60°F	2.60	0.23	1.15	0.15	2.56	0.20	2.20	0.19
											+50°F	2.35	0.21	1.11	0.14	2.30	0.19	1.90	0.17
											+40°F	2.10	0.19	0.90	0.13	2.00	0.18	1.55	0.15
HP3702	V	4	11-1/8	4.6	3.6	4.2	4.0	3.6	KN		+20°F	1.31	0.17	0.54	0.11	1.25	0.16	1.00	0.12
											0°F	0.89	0.13	0.36	0.10	0.85	0.13	0.70	0.10
											+60°F	3.80	0.27	2.20	0.16	3.7	0.25	3.6	0.25
											+50°F	3.50	0.25	2.00	0.15	3.4	0.24	3.2	0.24
											+40°F	3.15	0.23	1.62	0.14	3.0	0.22	2.8	0.22
HP3703	V	4	11-3/8	5.2	3.5	4.1	4.0	3.7	KN		+20°F	2.21	0.19	1.03	0.11	2.1	0.18	2.0	0.18
											0°F	1.57	0.17	0.63	0.10	1.5	0.16	1.4	0.15
											+60°F	5.20	0.65	2.70	0.39	5.0	0.60	4.9	0.60
											+50°F	4.70	0.60	2.50	0.37	4.5	0.57	4.4	0.57
											+40°F	4.20	0.55	2.25	0.35	4.0	0.53	4.0	0.53
											+20°F	3.15	0.47	1.62	0.30	3.0	0.45	3.0	0.45
											0°F	2.41	0.41	0.87	0.25	2.3	0.39	2.0	0.39
											+60°F	12.0	0.88	5.50	0.56	11.9	0.84	11.5	0.84
											+50°F	10.8	0.84	5.00	0.53	10.75	0.80	10.5	0.80
											+40°F	9.45	0.80	4.35	0.48	9.0	0.76	9.0	0.76
											+20°F	6.51	0.68	2.88	0.43	6.2	0.65	6.0	0.65
											0°F	4.51	0.59	1.83	0.36	4.3	0.56	4.0	0.56
HP3700	V	6	15	13.0	11.5	13.1	12.9	11.4	MN		+60°F	21.5	2.30	9.00	1.60	21.1	2.20	19.0	2.20
											+50°F	19.5	2.20	8.00	1.50	19.0	2.10	17.0	2.10
											+40°F	17.8	2.10	7.20	1.35	17.0	2.00	15.0	2.00
											+20°F	11.5	2.00	5.40	1.16	11.0	1.90	10.0	1.90
											0°F	8.08	1.68	3.42	0.97	7.7	1.60	7.0	1.60
											+60°F	36.0	2.50	14.5	1.50	35.6	2.10	32.0	2.10
											+50°F	33.0	2.30	13.0	1.40	32.0	2.0	29.0	2.00
											+40°F	29.4	2.10	11.7	1.35	28.0	2.00	25.0	2.00
											+20°F	19.9	2.00	8.1	1.16	19.0	1.9	18.0	1.90
											0°F	13.6	1.68	5.4	0.97	13.0	1.6	12.0	1.60

Suction Accumulators of 6" diameter or smaller are  and  LISTED File No. SA2400 (Hydrogen copper brazed construction)

† Maximum and minimum recommended tons based on pressure drop and oil return through Suction Accumulator.

• Suction Accumulators rated for 450 PSI.

Length includes nipples.



File No. SA 2400

“Leek Pruf”[®] Fusible Plugs

- The “Leek Pruf”[®] plug has a male flare to connect to a female flare on the receiver or accumulator. A soft copper gasket which comes attached and oiled is used and pipe compound is eliminated. The result is a permanent leak tight connection.
- Alloy in the “Leek Pruf”[®] plug is located so that it is not disturbed or under stress when the plug is tightened since the section of the plug containing alloy is not contained within the threaded section. Since “Leek Pruf”[®] plugs by Refrigeration Research use an eutectic alloy (melts sharply at one temperature) and the alloy is not distorted, the relief temperature is positive.

alloy not under stress

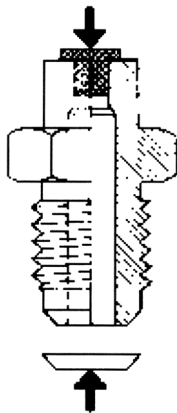

Attached Copper gasket makes permanent seal

LEEK PRUF[®] PLUGS ARE EXCLUSIVE ON RECEIVERS AND ACCUMULATORS BY REFRIGERATION RESEARCH.

APPROVED AND USED BY LEADING CONDENSING UNIT AND SYSTEM MANUFACTURERS.



FITTING TO RECEIVER 1/4 SAE FLARE PART NO.	FITTING TO RECEIVER 3/8 SAE FLARE FITTING TO OUTSIDE TUBE 1/2 SAE FLARE PART NO.
982-430°	984-430°

U.S. Patent Nos. 3,139,103; 5,076,313

Fusible Alloy: 430°F



File No. SA 3584



A.S.M.E. SUCTION ACCUMULATORS (R410A)

- Refrigeration Research, Inc. is pleased to announce new, A.S.M.E. certified suction accumulators intended for use with R410A refrigerant.
- A.S.M.E. suction accumulators available in standard sizes and volumes, to make your transition to R410A as seamless as possible.
- All A.S.M.E. suction accumulators are finished with corrosion-resistant powder paint suitable for most harsh environments.
- Refrigeration Research, Inc. also has the ability to provide Canadian Registration Numbers with these quality components.
- CE documentation provided upon request.

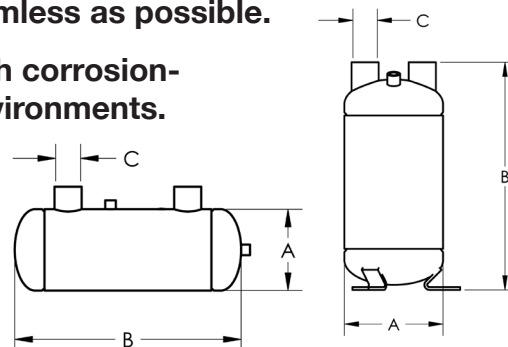
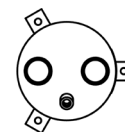

APPLICATION DATA FOR A.S.M.E. SUCTION ACCUMULATORS 450 P.S.I. A.S.M.E. DESIGN PRESSURE

PART NUMBER	VERTICAL OR HORIZONTAL	DIAMETER (INCHES)	# LENGTH	WEIGHT	MAXIMUM REFRIGERANT HOLDING CAPACITY (LBS.)				HX INLET I.D.	SUCTION INLET OUTLET I.D. SIZE	EVAP TEMP	† RECOMMENDED TONS OF REFRIGERATION											
												REFRIGERANT											
					R-410A		R-134a					R-22		R-404a		R-410A		R-134a		R-22		R-404a	
					MAX	MIN	MAX	MIN				MAX	MIN	MAX	MIN	MAX	MIN	MAX	MIN	MAX	MIN		
3648	V	8-5/8	20	44	27.5	31.3	30.9	27.2	3/4"	1-5/8	+40°F	29.40	2.10	11.70	1.35	28.00	2.00	25.00	2.00				
HX3648	V	8-5/8	20	50	27.5	31.3	30.9	27.2			+20°F	19.90	2.00	8.10	1.16	19.00	1.90	18.00	1.90				
											0°F	13.60	1.68	5.40	0.97	13.00	1.60	12.00	1.60				
											-20°F	8.40	1.36	3.60	0.87	8.00	1.30	7.00	1.30				
											-40°F	5.25	1.15	1.80	0.68	5.00	1.10	4.00	1.10				
3642	V	8-5/8	20	44	27.5	31.3	30.9	27.2	7/8"	2-1/8	+40°F	61.90	5.46	28.80	3.57	59.00	5.80	55.00	5.80				
3649	V	10-3/4	20	60.5	45	51	50	44			+20°F	43.00	5.09	18.90	3.09	41.00	5.20	39.00	5.20				
HX3642	V	8-5/8	20	50	27.5	31.3	30.9	27.2			0°F	28.30	4.51	12.60	2.51	27.00	4.30	26.00	4.30				
HX3649	V	10-3/4	20	66.5	45	51	50	44			-20°F	18.50	3.88	7.20	2.03	18.00	3.70	16.00	3.70				
											-40°F	12.60	2.83	4.50	1.64	12.00	2.70	10.00	2.70				
HX3847	H	8-5/8	24	63	39.8	45.2	44.6	39.5	1-3/8"	2-5/8	+40°F	94.50	9.97	45.00	5.70	90.00	9.50	85.00	5.80				
3643	V	10-3/4	20	57	45.2	51.4	50.7	44.7	+20°F		65.10	8.82	29.70	5.02	62.00	8.40	60.00	5.20					
3847	H	8-5/8	24	48	39.8	45.2	44.6	39.3	0°F		44.10	7.35	19.80	4.06	42.00	7.00	40.00	4.30					
8830	H	8-5/8	48	106	66	75.1	74.2	65.3	-20°F		29.40	6.30	11.70	3.28	28.00	6.00	25.00	3.70					
HX3643	V	10-3/4	20	66.5	45	51	50	44	1-3/8"		-40°F	18.50	4.41	7.20	2.70	18.00	4.20	15.00	2.70				
HX3644	V	10-3/4	26	85	64	72	72	63	1-3/8"	3-1/8	+40°F	136.50	15.70	63.0	9.66	130.0	15.0	125.0	15.00				
3644	V	10-3/4	26	75	64.6	72.7	72.5	63.9	+20°F		94.50	13.60	48.60	8.40	90.00	13.0	90.0	13.00					
3846	H	10-3/4	24	63	62.8	71.3	70.4	62	0°F		63.00	11.50	33.30	6.57	60.00	11.00	60.00	11.00					
3645	V	12-3/4	26	100	85.4	93.5	93	84	-20°F		42.00	9.76	20.70	5.89	40.00	9.30	40.00	9.30					
HX3846	H	10-3/4	24	72	62	71	70	61	1-3/8"		-40°F	29.40	7.87	11.70	4.64	28.00	7.50	25.00	4.50				

† Maximum and minimum recommended tons based on pressure drop and oil return through Suction Accumulator.

HX designates Heat Exchanger - Suction Accumulator with heat exchanger coil added for increased liquid line subcooling.

Length includes nipples.



No Sweat-No Frost Suction Accumulator

by **REFRIGERATION RESEARCH**, INC.

The “No Sweat” – “No Frost” Heat Exchanger Suction Accumulator **PREVENTS** frost and condensation and **PROTECTS** from corrosion and water damage. With innovative system design it can also serve as a receiver as well as a heat exchanger, thereby saving additional space.

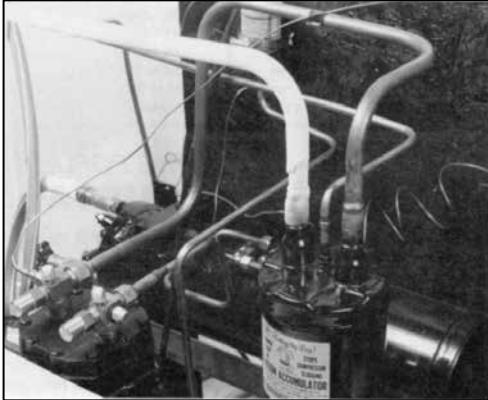

These heat exchanger – suction accumulators benefit a system in four ways: 1) Protects the compressor from refrigerant floodback 2) Subcools the liquid refrigerant for greater system efficiency 3) Stops condensation and frost from forming through unique design 4) Saves space by combining the suction accumulator, and heat exchanger all in one component to provide a more compact design.

Accumulator does not sweat or frost. Therefore cost of insulating accumulator is eliminated. Greater heat exchange surface improves efficiency.

PART NO.	HORIZONTAL OR VERTICAL	DIAMETER	# LENGTH	WEIGHT	MAXIMUM REFRIGERANT HOLDING CAPACITY (LBS)				UL CODE IDENT	SUCTION LINE I.D.	LIQUID LINE I.D.	EVAP TEMP	† RECOMMENDED TONS OF REFRIGERATION									
					R-410A	R-134a	R-22	R-404a					R-410A		R-134a		R-22		R-404a			
													MAX	MIN	MAX	MIN	MAX	MIN	MAX	MIN		
HXM3701	V	5	9-3/8	11	1.9	2.2	2.1	1.9	KN	5/8	3/8	+40°F	2.10	0.19	0.90	0.13	2.00	0.18	1.55	0.15		
														+20°F	1.31	0.17	0.54	0.11	1.25	0.16	1.00	0.12
HXM3702	V	5	11-1/8	12	3.6	4.1	4	3.7	KN					0°F	0.89	0.13	0.36	0.10	0.85	0.13	0.70	0.10
														-20°F	0.58	0.11	0.22	0.08	0.55	0.11	0.45	0.08
														-40°F	0.36	0.09	0.13	0.06	0.35	0.09	0.25	0.07
												+40°F	3.15	0.23	1.62	0.14	3.00	0.22	2.80	0.22		
HXM3703	V	5	11-3/8	12	3.5	4.1	4	3.7	KN	3/4	3/8	+20°F	2.21	0.19	1.03	0.11	2.10	0.18	2.00	0.18		
														0°F	1.57	0.17	0.63	0.10	1.50	0.16	1.40	0.15
														-20°F	1.15	0.13	0.43	0.09	1.10	0.13	0.80	0.13
														-40°F	0.60	0.10	0.25	0.06	0.60	0.10	0.50	0.10
														+40°F	4.20	0.55	2.25	0.35	4.00	0.53	4.00	0.54
HXM3738	V	5	13-1/8	10	7	6.3	6.2	5.5	EN	7/8	3/8	+20°F	3.15	0.47	1.62	0.30	3.00	0.45	3.00	0.45		
														0°F	2.41	0.41	0.87	0.25	2.00	0.39	2.00	0.39
														-20°F	1.57	0.34	0.63	0.20	1.50	0.33	1.30	0.33
														-40°F	0.94	0.28	0.36	0.16	0.90	0.27	0.70	0.27
														+40°F	9.45	0.80	4.35	0.48	9.00	0.76	9.00	0.76
HXM3700	V	6	15	17	11.5	10.3	10.1	9	MN	1-1/8	1/2	+20°F	6.51	0.68	2.88	0.43	6.20	0.65	6.00	0.65		
														0°F	4.51	0.59	1.83	0.36	4.30	0.56	4.00	0.56
														-20°F	2.94	0.49	1.21	0.29	2.80	0.47	2.50	0.47
														-40°F	1.89	0.39	0.78	0.15	1.80	0.38	1.40	0.38
														+40°F	17.80	2.10	7.20	1.35	17.00	2.00	15.00	2.00
HXM3706	V	6	20-1/4	23	15.6	13.9	13.7	12	MN	1-3/8	5/8	+20°F	11.50	2.00	5.40	1.16	11.00	1.90	10.00	1.90		
														0°F	8.08	1.68	3.42	0.97	7.70	1.60	7.00	1.60
														-20°F	5.25	1.36	2.16	0.87	5.00	1.30	4.50	1.30
														-40°F	3.15	1.15	1.26	0.68	3.00	1.10	2.50	1.10
														+40°F	29.40	2.10	11.70	1.35	28.00	2.00	25.00	2.00
HXM3704	V	6	25	30	20.1	17	16.8	14.7	MN	1-5/8	5/8	+20°F	19.90	2.00	8.10	1.16	19.00	1.90	18.00	1.90		
														0°F	13.60	1.68	5.40	0.97	13.00	1.60	12.00	1.60
														-20°F	8.40	1.36	3.60	0.87	8.00	1.30	7.00	1.30
														-40°F	5.25	1.15	1.80	0.68	5.00	1.10	4.00	1.10

Made under one or more of the following patents: nos.: 5,479,790; 5,722,146; 6,253,572; And patents applied for.

• Suction Accumulators rated for 450 PSI.



DISCHARGE MUFFLERS

Some systems are noisy due to vibration and pulsation of gas through the discharge line. To smooth out pulsations and reduce vibration and noise, Refrigeration Research offers the industry's most complete line of Discharge Mufflers.

Refrigeration Research has long been a leading manufacturer of mufflers in production quantities and was first to offer a complete catalog line.

All mufflers are of hydrogen copper brazed steel construction insuring maximum strength and complete cleanliness.

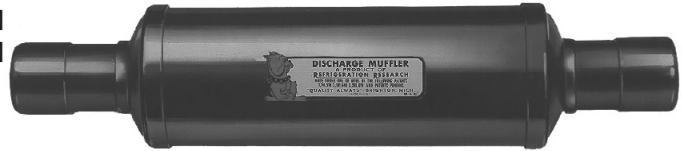

M-20 DISCHARGE MUFFLER SHOWN

CATALOG NUMBER	PART NUMBER	TONS	O.D.	OVERALL LENGTH	FITTING SIZE	WEIGHT (LBS.)	REMOVABLE FUSIBLE PLUG	UL CODE
M-2	1760	2	2	7-7/16	3/8	1.0	Not Required	MUF2
M-3	1761	3	2	7-7/16	1/2	1.0	Not Required	MUF2
M-5	1762	5	2	7-7/16	5/8	1.0	Not Required	MUF2
M-10	1758	7-1/2 to 10	3	9	7/8	2.6	Not Required	MUF3
M-15	1792	10 to 15	3	9-1/4	1-1/8	2.8	Not Required	MUF3
M-20	1771	15 to 25	3	13-3/4	1-3/8	3.3	Not Required	MUF3
M-30	1772	25 to 50	4	16	1-5/8	6.5	Installed	MUF4
M-60	1790	50 to 75	6	26-1/2	2-1/8	26.0	Installed	MUF6
M-80	1791	75 to 100	6	28	2-5/8	27.0	Installed	MUF6
M-110	1793	100 to 125	6	36	3-1/8	32.5	Installed	MUF6

•Mufflers are rated for 450 PSI.



File No. SA 3089

THE POPULAR AND EXCLUSIVE ADJUSTABLE MUFFLER

This original discharge muffler development by Refrigeration Research permits "tuning" the muffler to the system.

For the first time it is possible to change muffler characteristics without installing a different muffler or even breaking into the system. In fact the muffler may be adjusted without losing charge and while the system is in operation.

The adjustable muffler is provided with a stem which may be turned to "tune" the muffler to the system. It is a well known fact that two systems made up of the same components do not always sound the same when installed in different locations. One may be noisy while the other is relatively quiet. Individual compressor characteristics, length and diameters of lines and other factors may make the difference.

The Bull Dog Adjustable Muffler by Refrigeration Research provides a variable range of muffler characteristics so that the best performance with a particular system can be attained.

Contact our engineering department for use with R 410A refrigerant.



CATALOG NUMBER	PART NUMBER	TONS	O.D.	OVERALL LENGTH	FITTING SIZE	WEIGHT (LBS.)	UL CODE
AM-5	1825	2 to 5	4	10	5/8	5.5	AM4
AM-10	1824	5 to 10	4	11	7/8	6	AM4
AM-25	1823	10 to 25	4	14-1/4	1-1/8	7.5	AM4

•Rated for 450 PSI.



File No. SA 3089

All mufflers are in accordance with latest and requirements, diameters above 3" being furnished complete with Refrigeration Research "Leek Pruf"[®] fusible plugs installed. All mufflers may be mounted horizontally or vertically as long as instructions are followed. CE documentation available upon request.



HIGHER PRESSURE **BULL DOG** DISCHARGE MUFFLERS

These "Green Label" discharge mufflers are uniquely designed for the higher pressure requirements for systems using R-410A. The tough requirements needed for these special models are made to the approved Underwriters Laboratory requirements necessary to meet the 675 p.s.i.g. working pressure.*Models MH-30, MH-60, MH-80 and MH-110 require pressure relief valve (not supplied). The chart below shows the models available.

CATALOG NUMBER	PART NUMBER	TONS	FITTING SIZE (INCHES)	O.D. (INCHES)	OVERALL LENGTH	UL CODE
MH-2	1718	2	3/8	2	7-7/16	MRN
MH-3	1719	3	1/2	2	7-7/16	MRN
MH-5	1720	5	5/8	2	7-7/16	MRN
MH-10	1721	7-1/2 to 10	7/8	3	9	MSN
MH-15	1722	10 to 15	1-1/8	3	9-1/4	MSN
MH-20	1723	15 to 25	1-3/8	3	13-3/4	MSN
MH-30*	1725	25 to 50	1-5/8	4	16	MTN
MH-60*	1728	50 to 75	2-1/8	6	26-1/2	MVN
MH-80*	1745	75 to 100	2-5/8	6	28	MVN
MH-110*	1746	100 to 125	3-1/8	6	36	MVN

*4" O.D. and above require pressure relief valve, not supplied.

Rated for 675 PSI.



File No. SA 3089

SUCTION MUFFLER

These mufflers smooth out suction pulsations resulting in reduced system noise when installed at the compressor on the suction side. They are of hydrogen copper brazed steel construction for maximum strength and complete cleanliness with copper nipples for ease of installation.



PART NUMBER	TONS	OVERALL LENGTH	FITTING SIZE	WEIGHT (LBS.)	UL CODE
1677	4-1/2 to 5	6-1/8	7/8" I.D. (IN)	1	SM-088
			7/8" I.D. (OUT)		
1678	6 to 10	6-1/8	1-1/8" I.D. (IN)	1	SM-113
			1-1/8" O.D. (OUT)		
1679	7-1/2 to 12-1/2	6-1/8	1-3/8" I.D. (IN)	1	SM-138
			1-3/8" I.D. (OUT)		

All mufflers are in accordance with and requirements.
Rated for 450 PSI



File No. SA 3089



RECEIVERS WITHOUT VALVES

(U.L. RECOGNIZED)

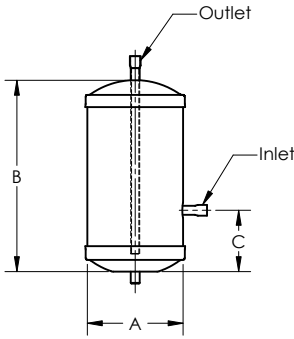

These reliable UL recognized receivers provide excellent durability and flexibility to fit a variety of applications as either replacement parts or for original equipment. The hydrogen brazed construction provides superior internal cleanliness. They are 100% pressure tested to ensure integrity and powder coated for excellent corrosion resistance. The recessed cap and 3/8" or 1/2" mounting stud provide a sturdy base for mounting in the vertical position (all parts must mount vertically).

These receivers, unlike other receivers, do not have fusible plugs and must be used only where a pressure relief or fusible is installed elsewhere in the system. These parts can be made with 430°F Fusible installed and UL listed upon special order and in quantity.

PART NUMBER	PUMP DOWN CAPACITY	"A" DIAMETER	"B" LENGTH	INLET CONNECTION	"C" INLET DIMENSION	OUTLET CONNECTION	UL CODE
5721	1.5 LBS.	3"	7"	1/4" SWEAT	2.37"	1/4" SWEAT	HN
5722	3 LBS.	4"	8"	3/8" SWEAT	2.56"	3/8" SWEAT	KN
5723	7 LBS.	5"	12"	3/8" SWEAT	2.69"	3/8" SWEAT	EN
5724	10 LBS.	6"	12"	3/8" SWEAT	2.81"	3/8" SWEAT	MN
5727	13 LBS.	6"	15"	1/2" SWEAT	2.81"	1/2" SWEAT	MN
5728	17 LBS.	6"	19"	1/2" SWEAT	2.81"	1/2" SWEAT	MN

*90% AT 90° for R22, R134a and R502 - For R12 multiply by 1.1 - For R402b and R404a multiply by 0.9

• Receivers rated for 500 PSI.



File No. SA 2400 Vol. 2

Models available for use with R410A, contact our engineering department

BULL'S EYE SIGHT GLASSES

Regular and "moisture-indicating" Bull's Eye Sight Glasses provide a full view of the refrigerant level at all times. The sight glasses are plated steel with 5/16" diameter polyethylene "floating" ball. They must be sealed with "Loctite" Refrigerant Sealer No. 55441 (or similar sealer) around the 1/2 - 14 NPTF thread. THIS SIGHT GLASS IS SUITABLE FOR R410A.



Regular - Part No. 1523

Moisture Indicating - Part No. 1536

PRISM SIGHT GLASSES

The prism sight glass eliminates the need for the polyethylene floating ball. For use with fittings 1/2 - 14 NPTF thread and Refrigerant Sealer.



Prism Sight Glass
RR Part No. 7690

WELDED SIGHT GLASSES

Contact engineering department for application details.

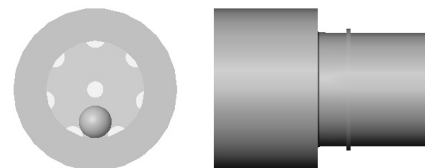



Welded Sight Glass
RR Part No. 1521



RECEIVERS

Refrigeration Research Receivers have been made continuously for over 50 years. Standard catalog models are shown below, however, hundreds of special models are made as well. They are used widely by original equipment manufacturers throughout the industry. They are backed by a reputation for quality and service. Contact engineering department for special designs.

Available in a broad range of types and sizes, these receivers with valves and fittings attached are hydrogen brazed for cleanliness and pressure tested for reliability. A 430°F Fusible plug is installed on all receivers except #2030, #2038, #2039, and #9028. All valves are supplied with steel stem caps with copper gaskets and brass flare nuts and caps. All receivers are powder coated for excellent corrosion resistance. Pressure tested for 500 p.s.i. maximum working pressure.

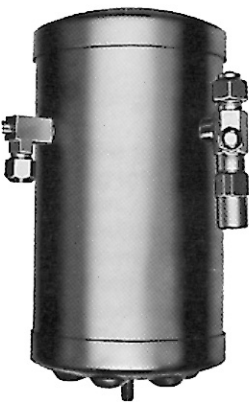
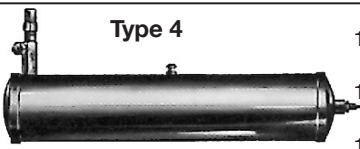
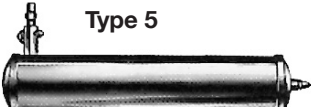
 Type 1	PART NUMBER	*PUMP DOWN CAPACITY	DIAMETER & LENGTH OVER END CAPS	INLET	OUTLET	WT. LBS.	 CODE Ident.
Vertical Mount	2030	2 lb.	3 x 10	1/4 ID Sweat	1/4 ID Sweat	2.4	HN
	2038	1.5 lb.	2 x 8	1/4 ID Sweat	1/4 O.D. Copper Nipple	1.0	AL
	2039	1.5 lb.	3 x 7	1/4 ID Sweat	1/4 ID Sweat	2	HN
 Type 2	1947	3 lb.	3 1/2 x 9	3/8 ID Sweat	3/8 SAE Valve	3.3	PN
 Type 3	5774	2 lb.	3 x 10	1/4 SAE Fitting	1/4 SAE Valve	3	HN
	9028	2 lb.	3 x 10	1/4 ID Sweat	1/4 ID Sweat Valve	3	HN
	1920	2 lb.	3 1/2 x 7 1/2	1/4 SAE Fitting	1/4 SAE Valve	2.9	PN
	1917	3 lb.	3 1/2 x 10	1/4 SAE Fitting	1/4 SAE Valve	3.5	PN
	9017	3 lb.	3 1/2 x 10	1/4 ID Sweat	1/4 ID Sweat Valve	3.5	PN
	1921	4 lb.	4 x 10	1/4 SAE Fitting	1/4 SAE Valve	4.5	KN
	9021	4 lb.	4 x 10	1/4 ID Sweat	1/4 ID Sweat Valve	4.5	KN
	1918	6 lb.	5 x 10	1/4 SAE Fitting	1/4 SAE Valve	7.2	EN
	5315	6 lb.	5 x 10	3/8 SAE Fitting	3/8 SAE Valve	7.3	EN
	6848	6 lb.	5 x 10	3/8 ID Sweat	3/8 ID Sweat Valve	7.3	EN
	1911	10 lb.	6 x 12	3/8 SAE Fitting	3/8 SAE Valve	10.9	MN
	6801	10 lb.	6 x 12	3/8 ID Sweat	3/8 ID Sweat Valve	10.9	MN
	3212	16 lb.	6 x 18	1/2 SAE Fitting	1/2 SAE Valve	15.6	MN
	9027	16 lb.	6 x 18	1/2 ID Sweat	1/2 ID Sweat Valve	15.6	MN
3213	22 lb.	6 x 24	1/2 SAE Fitting	1/2 SAE Valve	18	MN	
 Type 4	1916	8 lb.	4 x 19	1/4 Sweat	1/4 SAE Valve	7.5	KN
	1915	12 lb.	5 x 18	1/4 Sweat	3/8 SAE Valve	11.4	EN
	1919	19 lb.	5 x 28	3/8 Sweat	3/8 SAE Valve	16.6	EN
 Type 5	1922	15 lb.	5 X 23	3/8 Sweat	3/8 SAE Valve	14.5	EN
	1923	15 lb.	5 x 23	1/2 Sweat	1/2 SAE Valve	15	EN

*90% AT 90° for R22, R134a and R502 - For R12 multiply by 1.1 - For R402b and R404a multiply by 0.9
500 psi Working Pressure

  LISTED

 marking available upon request. File No. SA 2400 Vol. 1



RECEIVERS FOR ROTALOCK FITTINGS

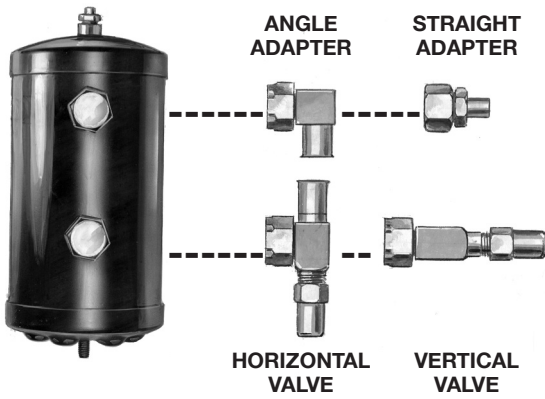

Receivers below are of hydrogen copper brazed construction insuring maximum cleanliness and strength.

These premium receivers are designed for either horizontal or vertical mounting and for use with Rotalock valves and fittings to make them as universal in application as possible. All of these receivers have "Leek Pruf"[®] fusible plugs installed and are powder coated.

Rotalock receivers do not include valves or fittings, but are supplied with Teflon Gasket installed. These receivers are pressure tested for 500 p.s.i. working pressure.

PART NUMBER	*PUMP DOWN CAPACITY	DIAMETER & LENGTH OVER END CAPS	INLET FITTING	OUTLET FITTING	MOUNT	LEEK PRUF FUSIBLE PLUG	WEIGHT POUNDS	UL CODE IDENT.
3392	4 lb.	4 x 10	1" Rotalock	1" Rotalock	Horiz. or Vert.	R	4.7	KN
3388	6 lb.	5 x 10	1" Rotalock	1" Rotalock	Horiz. or Vert.	R	7.3	EN
3390	13 lb.	5 x 20	1" Rotalock	1" Rotalock	Horiz. or Vert.	R	12.3	EN
3389	10 lb.	6 x 12	1" Rotalock	1" Rotalock	Horiz. or Vert.	R	11.1	MN
3413	16 lb.	6 x 18	1" Rotalock	1" Rotalock	Horiz. or Vert.	R	14.5	MN
3391	22 lb.	6 x 24	1" Rotalock	1" Rotalock	Horiz. or Vert.	R	18.3	MN
3387	28 lb.	6 x 30	1" Rotalock	1" Rotalock	Horiz. or Vert.	R	22.0	MN

*90% AT 90° for R22, R134a and R502 - For R12 multiply by 1.1 - For R402b and R404a multiply by 0.9
 P-Permanent R-Removable 500 psi Working Pressure

CE marking available upon request.



File No. SA 2400 Vol. 1

AVAILABLE 1" ROTALOCK VALVES AND FITTINGS FOR RECEIVERS

Horizontal Valves

- 27718 - 3/8 SAE flare
- 27689 - 1/2 SAE flare
- 27691 - 5/8 SAE flare

Horizontal Valves

- 23075 - 3/8 I.D. Sweat
- 24601 - 1/2 I.D. Sweat
- 24602 - 5/8 I.D. Sweat

Vertical Valves

- 27742 - 3/8 SAE flare
- 27035 - 1/2 SAE flare
- 27036 - 5/8 SAE flare

Vertical Valves

- 24606 - 3/8 I.D. Sweat
- 24490 - 1/2 I.D. Sweat
- 24491 - 5/8 I.D. Sweat

Straight Adapters

- 24246 - 3/8 I.D. Sweat
- 24247 - 1/2 I.D. Sweat
- 24248 - 5/8 I.D. Sweat

Teflon Gasket No. 24591

Angle Adapters

- 24957 - 3/8 SAE flare
- 24958 - 1/2 SAE flare
- 24959 - 5/8 SAE flare

Angle Adapters

- 24252 - 3/8 I.D. Sweat
- 24253 - 1/2 I.D. Sweat
- 24254 - 5/8 I.D. Sweat



ASME RECEIVERS FOR ROTALOCK FITTINGS

These larger receivers are assembled by shielded arc weld construction. They are made to ASME code and marked with an attached metal tag. Rotalock connections 1 1/4"-12 are used on these receivers for valves or fittings (not included) shown below. +Part numbers 3105 and 3106 are supplied with 1"-14 Rotalock connectors. A 1/2" pipe fitting is supplied for a pressure relief or a pop-off valve (not supplied). All parts are painted with epoxy powder coating. Working pressure is 450 p.s.i. maximum.

Welded mounting brackets are attached on the vertical models. Adjustable mounting brackets are also available for the horizontal models, but not included or attached to the part. RR7187 (8 5/8" Dia.); RR7188 (10 3/4" Dia.).

Special ASME receivers in quantity can be made upon request. These include different lengths, welded mounting brackets, higher working pressure, special fittings and fitting locations to suit your applications. Contact our Engineering Department about your needs.

**Part Number	*Pump Down Capacity	"A" Diameter	"B" Length Over Caps	Horz. Or Vert.	Shipping Wt.
3105+	19	8 5/8	12	Vert.	24
3106+	27	8 5/8	16	Vert.	29
3290	31	8 5/8	18	Vert.	38
3107	43	8 5/8	24	Vert.	41
3291	47	10 3/4	18	Vert.	50
3292	65	10 3/4	24	Vert.	65
3295	70	12 3/4	18	Vert.	70
3296	78	12 3/4	20	Vert.	78
3297	92	12 3/4	24	Vert.	92

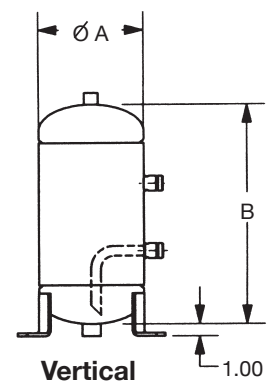

**Part Number	*Pump Down Capacity	"A" Diameter	"B" Length Over Caps	Horz. Or Vert.	Shipping Wt.
3108	51	8 5/8	28	Horz.	46
3285	66	8 5/8	36	Horz.	66
3109	78	8 5/8	42	Horz.	66
3286	90	8 5/8	48	Horz.	90
3287	104	10 3/4	36	Horz.	104
3288	141	10 3/4	48	Horz.	141

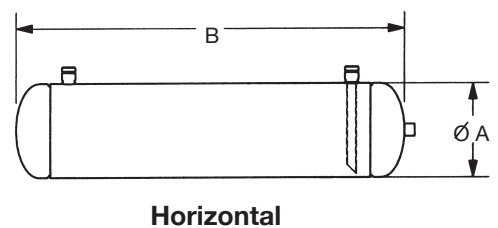

*90% AT 90° for R22, R134a and R502 - For R12 multiply by 1.1 - For R402b and R404a multiply by 0.9

**Models available for use with R410A, see page 16 and 17 or contact our engineering department.

Canadian registration numbers issued for all provinces and territories in Canada upon request.

AVAILABLE 1 1/4" ROTALOCK VALVES AND FITTINGS FOR ABOVE RECEIVERS

Horizontal Valves	Vertical Valves	Right Angle Adapters	Straight Adapters
24603 – 7/8" I.D. Sweat	24493 – 7/8" I.D. Sweat	24256 – 7/8" I.D. Sweat	24250 – 7/8" I.D. Sweat
24325 – 1 1/8" I.D. Sweat	24494 – 1 1/8" I.D. Sweat	24257 – 1 1/8" I.D. Sweat	24251 – 1 1/8" I.D. Sweat
Teflon Gasket No. 24592			



HIGHER PRESSURE **BULL DOG** RECEIVERS

These special Models are designed specifically for higher pressure requirements for use in R-410A systems. The tough requirements needed for these "Green Label" Models are made to the approved Underwriters Laboratory requirements necessary to meet the 675 p.s.i.g. working pressure.

Particular steel material requirements, along with special welded fabrication are used with our unique die designs to produce these superior high strength receivers. These come complete with a "Leak Pruf"[®] fusible plug installed as well as our powder coated finish. These are made with Rotolock connections for use with our valve and adapters (not included) also used on our other Rotolock receivers shown in the catalog. Rotolock models can be used for either vertical or horizontal mounting.

PART NUMBER	PUMP DOWN CAPACITY	"A" DIAMETER	"B" LENGTH	FIGURE	INLET & OUTLET CONNECTION	LEAK PRUF FUSIBLE PLUG	UL CODE
2041	1.3 LBS.	3"	7"	I	1/4" Sweat	Not Required	SN
2040	1.8 LBS.	3"	10"	I	1/4" Sweat	Not Required	SN
3307	1.8 LBS.	3"	10"	II	1" Rotolock	Not Required	SN
3308	3.6 LBS.	4"	10"	II	1" Rotolock	Installed	TN
3309	5.5 LBS.	5"	10"	II	1" Rotolock	Installed	UN
3310	9.0 LBS.	6"	12"	II	1" Rotolock	Installed	VN
3377	14.0 LBS.	6"	18"	II	1" Rotolock	Installed	VN
3378	19.3 LBS.	6"	24"	II	1" Rotolock	Installed	VN
3379	24.6 LBS.	6"	30"	II	1" Rotolock	Installed	VN

*90% AT 90°F - 675 PSI Working Pressure - U.S. Patent Number 5,076,313
CE Rating available upon request.



File No. SA 2400 Vol. 1

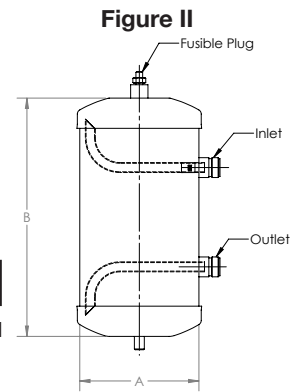
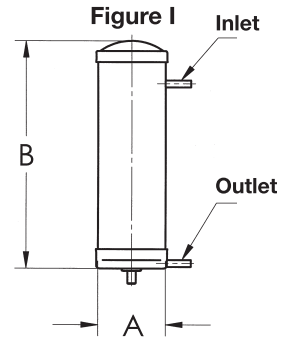

ROTALOCK VALVES AND ADAPTERS

Horizontal Valves	Vertical Valves	Straight Adapters	Angle Adapters
3/4" ROTALOCK VALVES AND ADAPTERS			
24474 - 1/4" I.D. Sweat		24683 - 1/4" I.D. Sweat	24686 - 1/4" I.D. Sweat
24475 - 3/8" I.D. Sweat		24516 - 3/8" I.D. Sweat	24515 - 3/8" I.D. Sweat
1" ROTALOCK VALVES AND ADAPTERS			
27718 - 3/8 SAE Flare	27742 - 3/8 SAE Flare	24246 - 3/8 I.D. Sweat	24957 3/8 SAE Flare
27689 - 1/2 SAE Flare	27035 - 1/2 SAE Flare	24247 - 1/2 I.D. Sweat	24958 - 1/2 SAE Flare
27691 - 5/8 SAE Flare	27036 - 5/8 SAE Flare	24248 - 5/8 I.D. Sweat	24959 - 5/8 SAE Flare
23075 3/8 I.D. Sweat	24606 - 3/8 I.D. Sweat		24252 - 3/8 I.D. Sweat
24601 - 1/2 I.D. Sweat	24490 - 1/2 I.D. Sweat		24253 - 1/2 I.D. Sweat
24602 - 5/8 I.D. Sweat	24491 - 5/8 I.D. Sweat		24254 - 5/8 I.D. Sweat
1-1/4" ROTALOCK VALVES AND ADAPTERS			
24603 - 7/8" I.D. Sweat	24493 - 7/8" I.D. Sweat	24250 - 7/8" I.D. Sweat	24256 - 7/8" I.D. Sweat
24325 - 1-1/8" I.D. Sweat	24494 - 1-1/8" I.D. Sweat	24251 - 1-1/8" I.D. Sweat	24257 - 1-1/8" I.D. Sweat
TEFLON GASKETS			
24590 - 3/4" Gasket			
24591 - 1" Gasket			
24592 - 1-1/4" Gasket			



ASME RECEIVERS FOR 600 P.S.I. (R410A)

These larger receivers are assembled by shielded arc weld construction. They are made to ASME code and marked with an attached metal tag. Rotalock connections of 1 1/4"-12 are used on these receivers for valves or fittings (not included) shown on page 15. +Part numbers 3110 and 3111 are supplied with 1"-14 Rotalock connections. A 1/2" pipe fitting is supplied for a pressure relief or a pop-off valve (not supplied). All parts are painted with epoxy powder coating. Working pressure for this product line is 600 p.s.i. maximum.

Welded mounting brackets are attached on the vertical models. Adjustable mounting brackets are also available for the horizontal models, but not included or attached to the part. RR7187 (8-5/8" Dia.); RR7188 (10-3/4" Dia.).

These special ASME receivers specifically designed for R410A refrigerant can be customized.

Part Number	*Pump Down Capacity	"A" Diameter	"B" Length Over Caps	Horz. Or Vert.	Shipping Wt.
3110+	17	8 5/8	12	Vert.	24
3111+	24	8 5/8	16	Vert.	29
3230	28	8 5/8	18	Vert.	38
3112	38	8 5/8	24	Vert.	41
3231	42	10 3/4	18	Vert.	60
3232	57	10 3/4	24	Vert.	72
3294	57	10 3/4	24	Vert.	72

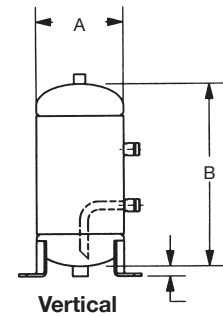

Part Number	*Pump Down Capacity	"A" Diameter	"B" Length Over Caps	Horz. Or Vert.	Shipping Wt.
3113	45	8 5/8	28	Horz.	46
3233	59	8 5/8	36	Horz.	84
3114	69	8 5/8	42	Horz.	66
3236	81	8 5/8	48	Horz.	100
3238	94	10 3/4	36	Horz.	100

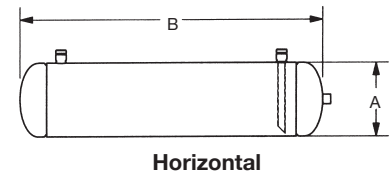

*90% at 90°F - 600 PSI Working Pressure CE Rating available upon request.
Canadian Registration numbers issued for all provinces and territories in Canada upon Request

AVAILABLE 1 1/4" ROTALOCK VALVES AND FITTINGS FOR ABOVE RECEIVERS

Horizontal Valves	Vertical Valves	Right Angle Adapters	Straight Adapters
24603 – 7/8" I.D. Sweat	24493 – 7/8" I.D. Sweat	24256 – 7/8" I.D. Sweat	24250 – 7/8" I.D. Sweat
24325 – 1 1/8" I.D. Sweat	24494 – 1 1/8" I.D. Sweat	24257 – 1 1/8" I.D. Sweat	24251 – 1 1/8" I.D. Sweat
Teflon Gasket No. 24592			



BIG DOG RECEIVER DRIERS

The Big Dog receiver-drier combines the Bull Dog receiver with the Bull Dog driers, both rated for 500 psi, into one component to save space and eliminate brazing joints. Eliminating brazing joints reduces the source of potential leaks in a system and decreases introduction of debris from brazing. The hydrogen copper brazed steel construction provides maximum strength and interior cleanliness.

The Big Dog receiver-drier comes standard with a sight glass, the only standard model available anywhere with this feature. The moisture indicating ring in the sight glass provides important feedback for both the liquid level and the system moisture.

The entire receiver can be isolated from the system by rotalock valves and easily replaced or removed for maintenance. The flow through drier portion provides twice as much drier capacity as standard model driers for greater moisture absorption and a longer life cycle.

The captivated loose fill desiccant provides greater area for maximum drying effectiveness and the receiver-drier is suitable for bi-flow when mounted in the horizontal position for flexibility of application.

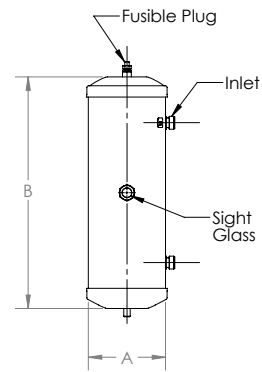

CATALOG NUMBER	PUMP DOWN CAPACITY	SHELL DIAMETER "A"	OVERALL LENGTH "B"	NOMINAL TONS	ROTALOCK CONNECTION	UL CODE IDENTIFIER
3135	2.5 lbs.	4"	10"	1/4 to 5	1"-14	KN
3136	7 lbs.	6"	12"	2 to 7 1/2	1"-14	MN
3137	12 lbs.	6"	18"	5 to 15	1"-14	MN



File No. SA 2401 Vol. 1

SHELL & COIL TYPE CONDENSER-RECEIVERS

These redesigned water cooled condenser-receivers are processed to insure cleanliness and reliability. Water circulates through a special finned copper coil. Capacities are conservatively rated.

The receivers are designed with refrigerant rotalock connections. This gives the installer the ability to rotate the position of the fittings on the receiver as he needs for installation. The receiver comes with a rotalock valve with a 3/8" sweat connection. Also included is an angle adapter with 3/8" SAE flare connection. However, when ordering the condenser, if a different valve or adapter is needed, they may be exchanged for a different one as shown in chart below.

All condenser-receivers are complete with our "Leak Pruf"® fusible plug and welded mounting brackets. All are pressure tested and UL listed for reliability and all are powder coated for corrosion protection.

The charts and diagrams below show dimensions and specifications.

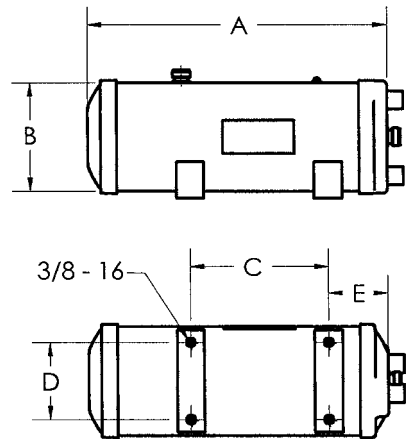

PART NO.	† TONS	CONNECTIONS		WATER CONNECTION	**RECEIVER PUMP DOWN CAPACITY	UL CODE	DIMENSIONS (INCHES)					WEIGHT (LBS.)
		OUTLET ROTALOCK CONNECTION	INLET ROTALOCK CONNECTION				A	B	C	D	E	
5803	1/2	3/4"	1"	1/2" SAE Fem. Flare	7 lbs.	ON	14	5	7-1/2	2-1/2	3	18
5806	3/4	1"	1"	1/2" SAE Fem. Flare	11 lbs.	FN	14	6	7-1/2	4-1/4	3-3/16	22
5802	1	1"	1"	1/2" SAE Fem. Flare	14 lbs.	FN	16-1/4	6	7-1/2	4-1/4	3-3/16	26
5804	1-1/2	1"	1"	1/2" SAE Fem. Flare	19 lbs.	FN	23-7/8	6	17-1/4	4-1/4	3-3/16	30

**90% AT 90° for R22 and R502 - For R12 and R134a multiply by 1.1 - For R402b and R404a multiply by 0.9

†Tons rating for 105°F condensing temperature



File No. SA 2400 Vol. 1





COAXIAL CONDENSERS

Coaxial water cooled condensers of various configurations are available as shown below. These counterflow condensers provide good performance at a minimum cost. Cataloged or special receivers up through 6" diameter can be provided for use with these condensers as a package for convenient hook-up. Inquiries for special runs are welcomed. All coaxial condensers come complete with brackets.

CE marking available upon request.



PART NUMBER	TONS	REFRIGERANT CONNECTIONS		WATER CONNECTIONS		OVERALL DIMENSIONS			WEIGHT (LBS.)	UL CODE
		IN	OUT	IN	OUT	H	L	W		
5027-S	1/3	3/8" I.D.	3/8" I.D.	1/2" I.D.	1/2" I.D.	3"	9-1/4"	6-1/2"	3	CC033
5028-S	1/2	3/8" I.D.	3/8" I.D.	1/2" I.D.	1/2" I.D.	3-7/8"	9-1/4"	6-1/2"	5	CC050
5022-S	3/4	3/8" I.D.	3/8" I.D.	1/2" I.D.	1/2" I.D.	4-3/4"	9-1/4"	6-1/2"	10	CC075
5023-S	1	3/8" I.D.	3/8" I.D.	1/2" I.D.	1/2" I.D.	5"	11"	8-1/2"	12	CC100
5024-S	1-1/2	3/8" I.D.	3/8" I.D.	5/8" I.D.	5/8" I.D.	4-1/4"	11-3/4"	10"	14	CC150
5025-S	2	1/2" I.D.	1/2" I.D.	5/8" I.D.	5/8" I.D.	5-1/4"	11-3/4"	10"	17	CC200
5026-S	3	1/2" I.D.	1/2" I.D.	5/8" I.D.	5/8" I.D.	6-1/2"	12-7/8"	12"	27	CC300
8267-S	1	1/4" S.A.E. FLARE	1/4" S.A.E. FLARE	1/2" I.D.	3/8" N.P.T	8"	11"	7-3/4"	11	ATCC100
8268-S	2	1/4" S.A.E. FLARE	1/4" S.A.E. FLARE	1/2" I.D.	3/8" N.P.T	9-3/4"	11"	7-3/4"	16	ATCC200

S-steel outer tube with copper inner tube
Copper outer tube available on special order

Dimensions subject to change without notice

DOUBLE WALL CLEANABLE DESUPERHEATING HEAT EXCHANGERS

These practical double wall desuperheating heat exchangers are of non-ferrous construction and provide a new standard of flexibility and convenience.

They are for use where local codes call for double wall type heat exchangers. The entire inner surface is quickly cleaned of water deposits with a wire brush by removing screw caps and standard washers. There are no bolts and gaskets to remove.

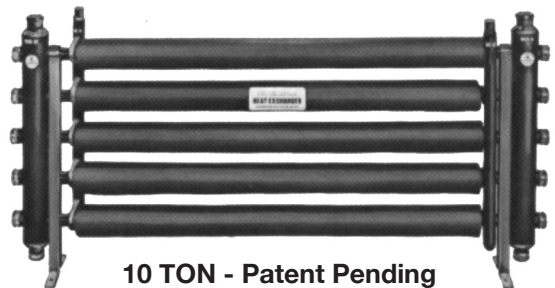

PART NUMBER	SYSTEM	MAX. BTU/HR. HEATED	MAX. GAL. TO BE HEATED 100°F	HORIZONTAL TUBES	HEIGHT INCHES	LENGTH INCHES	WEIGHT LBS.
5969	1 ton	2400	2.9	1	4.5"	37"	4
	2 ton	4800	5.8	1	4.5"	37"	4
5975	3 ton	7200	8.7	2	10.5"	37"	9
5976	5 ton	12,000	14.4	3	14.5"	37"	14
5977	7 1/2 ton	18,000	21.5	4	18.5"	37"	19
5978	10 ton	24,000	29.0	5	22.5"	37"	24



DESUPERHEATING HEAT EXCHANGERS

SUPERHEATED REFRIGERANT GAS TO WATER

(For commercial refrigeration, heat pumps, milk coolers, air conditioning, etc.)

For many years it has been known that the commercial refrigeration compressor can be used to provide an abundance of water at 150°F (or even 180°F) while at the same time doing its intended refrigeration job and at a saving of perhaps 8 to 10% of the electrical power it would normally use.

This is accomplished by installing a heat exchanger designed for interchange of heat between superheated refrigerant gas and water. SUCH A SYSTEM PROVIDES ONE OF THE MOST CERTAIN WAYS OF SAVING AN APPRECIABLE AMOUNT OF ENERGY AND AT COMPARATIVELY LOW INVESTMENT COST.

The heat exchanger is installed in the discharge line between the commercial refrigeration compressor and condenser, whether the condenser is of the water or air cooled type. The heat exchanger is designed to pick up not over 25% of the total rated load of the condenser.

In an ordinary commercial refrigeration system, about 30% of the work of the condenser is in reducing the superheated gas temperature to the condensing temperature. The balance of the work of the condenser is in condensing the gas to liquid and sub-cooling it.

Therefore, if the above mentioned heat exchanger is designed to pick up only the heat of the superheat, it is assured that only high temperature water will be provided. At the same time if the existing water or air cooled condenser does not have to handle the heat of superheat, it has additional capacity and the condensing temperature and pressure will drop causing the compressor to require less power.

Oversizing the heat exchanger would, of course, cause it to act somewhat as a water cooled condenser and the temperature of the water to be heated would be much lower.

With the addition of this type of heat exchanger, it is also advisable to add an insulated hot water storage tank of ample capacity.

Usually these heat exchangers should be installed on commercial systems using automatic or thermostatic expansion valves. Installation must always be made by a qualified refrigeration service engineer. If installation is made on a capillary fed system, it should be under the direction of a refrigeration engineer having knowledge of capillaries.

PART No.	REFRIGERATION TONS	WATER LINE OPENING	REFRIG. GAS LINE OPENING	MAX. BTU/HR. FOR WATER HEATER	MAX. GALS. TO BE HEATED 50° TO 150°/HR.	SHELL DIA.	LENGTH IN.	WEIGHT LB.
5836	3	5/8	5/8	7200	8.7	5	9	11.0
5837	5	5/8	7/8	12000	14.4	5	13	15.0
5838	7 1/2	5/8	1-1/8	18000	21.5	5	18	20.0
5839	10	5/8	1-3/8	24000	29.0	5	23	25.0

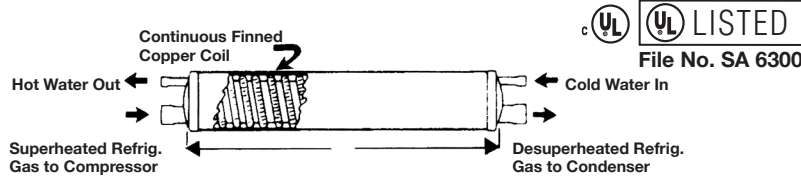
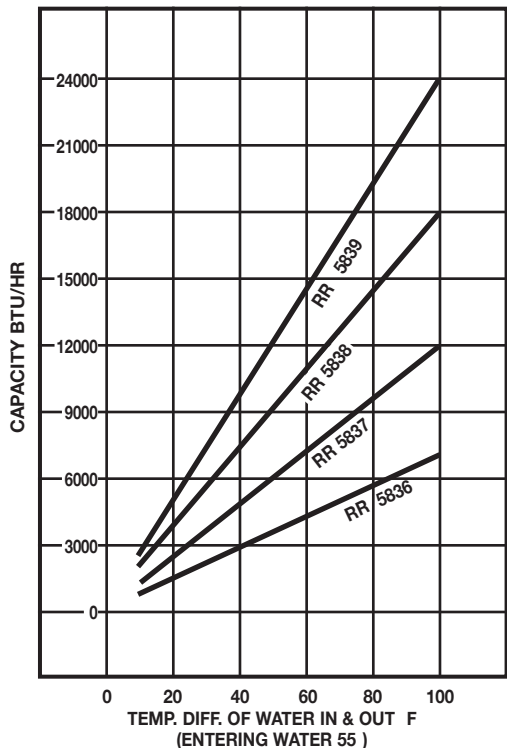

UL LISTED
File No. SA 6300

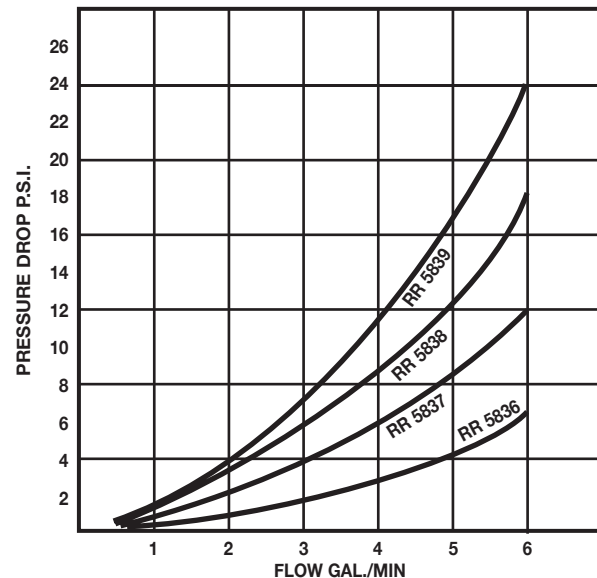

BLUE RIBBON SUBCOOLING HEAT EXCHANGERS



Blue Ribbon Heat Exchangers are particularly suited for suction cooled compressor applications. They are of all copper construction and incorporate a special expansion process providing positive contact between tube and body. Fittings are sized for standard units for 1/4 through 10 h.p., eliminating the need for adapter fittings. The Blue Ribbon series offer quality and high efficiency - at low competitive prices.

CATALOG NUMBER	H.P.	OVERALL LENGTH	SHELL O.D.	LIQUID LINE OPENING	SUCTION LINE OPENING	WEIGHT LBS.
BH 33	1/4 & 1/3	8	7/8	1/4	3/8	.6
BH 50	1/2	11	7/8	1/4	1/2	.8
BH 75	3/4	14	7/8	1/4	5/8	1.0
BH 100	1	15	7/8	3/8	5/8	1.5
BH 150	1-1/2	11	1-3/8	3/8	7/8	2.0
BH 200	2	13	1-3/8	3/8	7/8	2.0
BH 300	3	15	1-3/8	1/2	1-1/8	2.1
BH 500	5	15	2	1/2	1-1/8	2.3
BH 750	7-1/2	15	2	5/8	1-5/8	2.5
BH 1000	10	18	2	5/8	1-5/8	2.7

File No. SA 6300 c (UL) (UL) LISTED

DELUXE SUBCOOLING HEAT EXCHANGERS



Deluxe series Heat Exchangers are designed to provide a maximum of heat transfer efficiency with a minimum of pressure drop. They are conservatively rated in horsepower and therefore easy to select for a particular application.

Installation is simplified as connections are of proper size to match suction and liquid lines of standard units. Installation is neat as fittings are in the end caps and lines remain parallel.

Deluxe Heat Exchangers are of steel and copper construction. All heat exchangers are carefully leak tested under high pressure.

CATALOG NUMBER	H.P.	SHELL O.D. (B)	OVERALL LENGTH (E)	SUCTION LINE (C)	LIQUID LINE (D)	WEIGHT LBS.
H 33	1/4 & 1/3	2	8-5/8	3/8	1/4	.8
H 50	1/2	2	10	1/2	1/4	1.3
H 75	3/4	2	12-1/8	5/8	1/4	1.7
H 100	1	2	13-1/8	5/8	3/8	1.9
H 150	1-1/2	2	17-3/8	7/8	3/8	2.5
H 200	2	3	13-1/4	7/8	3/8	3.1
H 300	3	3	15-1/4	1-1/8	3/8	3.8
H 500	5	5	14-3/8	1-1/8	1/2	7.0
H 750	7-1/2	5	15-5/8	1-5/8	5/8	9.0
H 1000	10	5	18-5/8	1-5/8	5/8	11.0

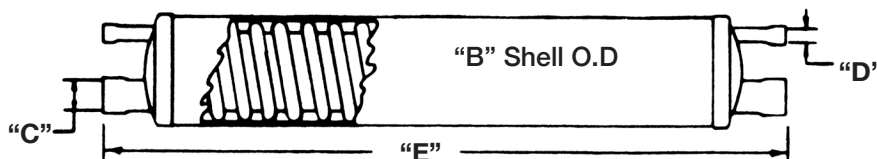

(UL) (UL) LISTED

File No. SA 6300
CE Documentation upon request.



OIL RESERVOIRS

These reservoirs may be used with the oil separator and an oil level regulator to return oil to the compressor.

PART NUMBER	"A" CAPACITY	"B" CAPACITY	TOTAL CAPACITY	LENGTH	UL CODE
5014	.75 gallon	.75 gallon	2 gallon	18"	MN
5014-1	.75 gallon	3 gallon	4 gallon	36"	MN

Rated for 500 PSI.



SA 2400 Vol. 1

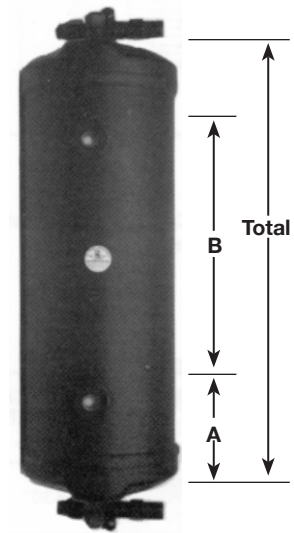

Oil Reservoirs are necessary on multiple, parallel compressor systems. They act as a holding vessel ready to feed oil to the oil level regulators as needed to maintain the proper oil level at each individual compressor and are essential for maintaining the proper balance of oil throughout the system. The valve at the top receives the oil from the oil separator while the valve at the bottom distributes it to the compressor crankcases. The top valve provides a convenient access port for adding oil to the system and the bottom valve likewise provides an access valve for removing oil if necessary based on the level indicated by the sight glasses. There is also a fitting at the top to attach the vent line with the pressure differential valve which regulates the pressure in the reservoir.

OIL LINE STRAINERS

The Oil Line Strainer prevents dirt and contaminants from entering the oil level regulator and the crankcase of the compressor.

Part No.	Inlet	Outlet	Sq. In. Screen Area	Screen Material	Overall Length
8671	3/8 Male Flare	3/8 Male Flare	11	100 Mesh Monel	4 7/8"

HEAT EXCHANGERS LIQUID TO LIQUID

These heat exchangers have been produced for many years by our Solar Research Division for use to provide heat interchange between liquid circulating from solar collectors and water in a storage tank. These can be used for other applications where a liquid to liquid heat exchange is needed.

A continuous copper coil runs through the heat exchanger eliminating all internal joints. A steel tube casing encloses the coil and an internal steel baffle slows the surrounding liquid inside the casing for maximum heat transfer.

CURVES BASED UPON WATER ENTERING COUNTERFLOW AT 150°F AND 55°F

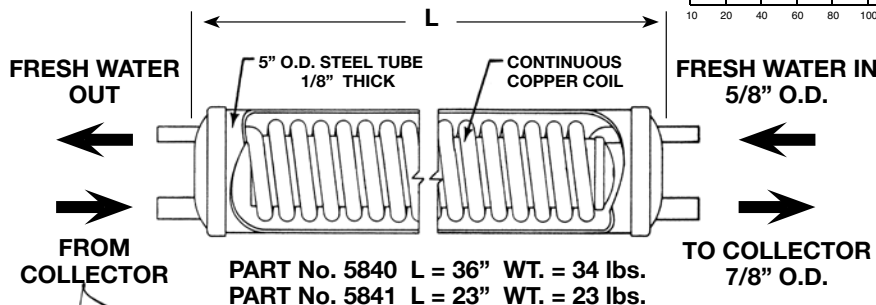
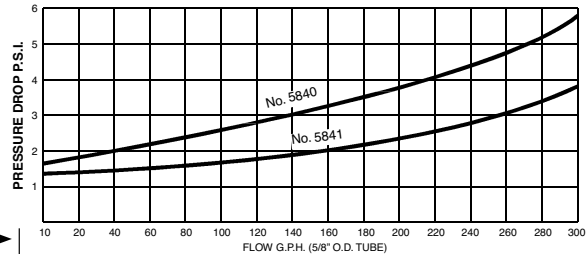
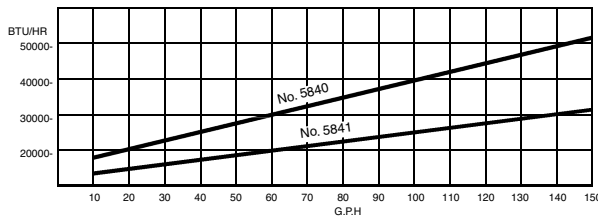

For larger capacities, heat exchangers may be connected in parallel with manifolds. Special larger capacity heat exchangers are available upon special order.



OIL SEPARATORS

FOR INCREASED EFFICIENCY AND . . . ENERGY SAVINGS

REFRIGERATION RESEARCH INC. offers oil separators for either single or multiple (parallel) compressor systems. All of these separators are hydrogen copper brazed and pressure tested to assure cleanliness and reliability.

The oil separators listed below contain an internal mechanical float to provide the return of oil to the crankcase of the compressor or the oil reservoir. A chart of special models below are for use for R-410A refrigerant.

PART NUMBER	DIMENSIONS		LINE SIZE		CAPACITY IN TONS OF REFRIGERATION						OIL PRECHARGE (oz.)	UL CODE
					R-12, R-134a		R-22, R-407C, R-502		R-404A, R-507			
	A	B	DISCHARGE LINES	OIL RETURN LINE	EVAPORATOR TEMP.		EVAPORATOR TEMP.		EVAPORATOR TEMP.			
					-40°F	+40°F	-40°F	+40°F	-40°F	+40°F		
8399	4	7 3/4	3/8	3/8	0.8	1.0	1.0	1.5	1.0	1.5	20	KN
8408	4	9 3/4	1/2	3/8	1.0	1.5	1.5	2.0	1.5	2.0	20	KN
8409	4	14	5/8	3/8	3.0	4.0	4.5	5.5	4.0	5.5	20	KN
8410	4	17	3/4	3/8	4.0	5.0	5.5	6.5	5.5	7.0	20	KN
8411	6	12	7/8	3/8	4.5	5.5	7.0	8.0	6.5	8.5	50	MN
8412	6	13 1/2	1 1/8	3/8	6.0	7.5	9.0	10.5	8.5	11.0	50	MN
8413	6	15 1/2	1 3/8	3/8	8.0	10.0	12.0	14.0	12.0	15.0	50	MN
8414	6	18	1 5/8	3/8	11.0	14.0	16.0	18.0	15.0	19.0	50	MN
8415*	6	19	2 1/8	3/8	18.0	21.0	25.0	30.0	24.0	31.0	50	MN

PART NUMBER	DIMENSIONS		LINE SIZE		CAPACITY (TONS OF REFRIGERATION)		OIL PRECHARGE (oz.)	UL CODE
					R-410A			
	A	B	DISCHARGE LINES	OIL RETURN LINE	-40°F	+40°F		
8379	4	7 3/4	3/8	3/8	1.5	2.3	20	OSTN
8381	4	9 3/4	1/2	3/8	2.3	3.0	20	OSTN
8382	4	14	5/8	3/8	6.9	8.5	20	OSTN
8383	4	17	3/4	3/8	8.5	10.0	20	OSTN
8384	6	12	7/8	3/8	10.8	12.4	50	OSVN
8387*	6	13 1/2	1 1/8	3/8	13.0	16.0	50	OSVN
8388*	6	15 1/2	1 3/8	3/8	18.5	21.7	50	OSVN
8393*	6	18	1 5/8	3/8	24.8	28.0	50	OSVN
8394*	6	19	2 1/8	3/8	35.0	45.0	50	OSVN

* Parts are type 2 - All Others are type 1
Available for CE rating.



File SA 2400 Vol. 1

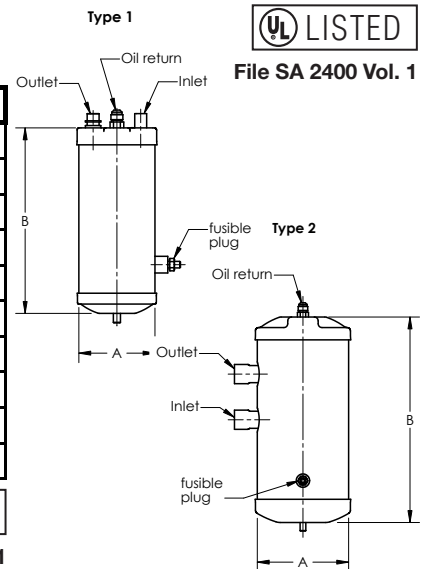

Mount all oil separators vertically. The smallest connection on the top, the 3/8" flare, returns

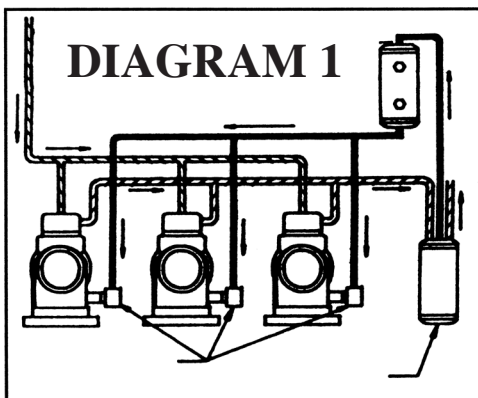

the oil to the compressor or to the top of the oil reservoir as shown in diagram 1. Connect the discharge line from the compressor to the nipple labelled "IN". The other nipple connects to the condenser.

Multiple (parallel) systems require oil level regulators attached to the crankcase of each individual compressor. Also, a pressure differential valve in a separate line from the oil reservoir to the common suction line regulates the pressure in the oil reservoir to prevent excessive pressure in the oil reservoir while still maintaining a positive pressure above the crankcase pressure.



SPECIAL O.E.M. PARTS

Refrigeration Research has made hundreds of special parts for original equipment manufacturers over many years. Many customers need similar parts for new products or replacements for repairs in the field. Below are a few receivers and suction accumulators which we now make available due to their popularity. These components are powder coated for a 500 hour salt spray test rating. Contact our engineering department for more component details.

Suction Accumulators

<u>Part No.</u>	<u>Description</u>	<u>Connections</u>
3488 (577-0421-01)	5" x 12"	1-1/4" Rotalock Inlet; 3/4" Sweat Outlet
3489 (577-0421-00)	6" x 13"	1-1/4" Rotalock Inlet; 7/8" Sweat Outlet
3656 (577-0286-01)	6" x 13"	7/8" Sweat Inlet; 1-1/4" Rotalock Outlet
7451 (577-0437-00)	6" x 13.5"	7/8" Sweat Inlet & Outlet with Sight Glass
7516	6" x 13.5"	7/8" Sweat Inlet & Outlet with Sight Glass

Receiver Replacements

<u>Copeland Part No.</u>	<u>Description</u>	<u>R.R. Equivalent Part No.</u>
077-C221-03	3" x 10" 1/4" in/out	5774
577-0435-00	3.5" x 10" 1/4" in/out	9017
077-C221-13	5" x 10" 3/8" in/out	5315
577-0019-00	5" x 10" 1/4" in/out	1918
577-0056-01	6" x 12" 3/8" in/out	6801
577-0420-01	6" x 20" 1/2" in/out	3212

Miscellaneous Receiver Replacement Parts

10.75" x 26" 1-3/8" in/out	3294
----------------------------	------

Contact Refrigeration Research, Inc. for additional cross reference items.





BULL DOG®



FOR DRIERS WITH SWEAT FITTINGS
ADD "S" TO THE CATALOG NUMBER
(EXAMPLE T-032 S)



Filter-Driers

In-Depth Filtration

**With XH-11 Desiccant— Recommended
by Desiccant Manufacturers for all
Refrigerants and Lubricants**

A large cylindrical inlet screen held by a strong spring keeps the desiccant securely in place. The inlet screen is designed to let some dirt particles through and become trapped in the maze of tightly held desiccant and the outlet filter. **Therefore, this drier can collect considerably more dirt than one which collects dirt only on a surface.**

All of the volume of desiccant in this drier is used efficiently to dry and clean the system since no binder is used. These driers are exceptionally high in acid removal capacity.

CATALOG NUMBER	FLARE FITTINGS	NOMINAL TONS	SHELL O.D.	OVERALL LENGTH	WEIGHT LBS.
T-032	1/4	1/4 – 1	2	4-7/16	.8
T-033	3/8	1/4 – 1	2	4-5/8	.8
T-052	1/4	1/3 – 2	2	5	1.0
T-053	3/8	1/3 – 2	2	5-1/8	1.0
T-083	3/8	1 – 4	2	5-7/8	1.2
T-084	1/2	1 – 4	2	6-1/4	1.21
T-163	3/8	2 – 5	3	6-1/2	1.57
T-164	1/2	2 – 5	3	6-7/8	1.58
T-304	1/2	3 – 7 1/2	3	9-7/8	2.3
T-305	5/8	3 – 7 1/2	3	10	2.31
T-414	1/2	5 – 10	3	10	3.2
T-415	5/8	5 – 10	3	10-1/8	3.2

The above driers provide interchangeability with other driers for convenience in service and they are available with pressure taps by special order.



File No. SA 2401 Vol. 1



“THE INDUSTRY’S MOST COMPLETE LINE OF QUALITY STRAINERS”

A wide selection of highest quality strainers is available for all applications. All joints are hard soldered or copper hydrogen brazed. Each strainer is individually tested under high pressure. Type FG and FH strainers contain 150 mesh monel screen. All other strainers contain screen of 100 mesh monel or stainless steel. All strainers below have cylindrical screens and copper shells except FA, FC, and FD which have steel shells. All U.L. recognized, U.L. listed upon request.



TYPE FC, FD, FE



TYPE FF, FJ, 2804, 554



TYPE FG



TYPE FA



TYPE FH

TYPE NUMBER	SQ. IN. SCREEN AREA	INLET	OUTLET	SHELL O.D.	OVERALL LENGTH	WEIGHT LBS.
FE 14	9	1/4 Flare	1/4 Flare	1-1/4	6-3/8	.4
FE 16	9	3/8 Flare	3/8 Flare	1-1/4	6-3/8	.4
FE 24	12	1/4 Flare	1/4 Flare	1-1/4	7	.5
FE 26	12	3/8 Flare	3/8 Flare	1-1/4	7-1/4	.5
FF 14	6	1/4 Sweat	1/4 Sweat	1-1/4	4-5/8	.3
FF 16	6	3/8 Sweat	3/8 Sweat	1-1/4	4-5/8	.3
FF 24	9	1/4 Sweat	1/4 Sweat	1-1/4	5-5/8	.4
FF 26	9	3/8 Sweat	3/8 Sweat	1-1/4	5-5/8	.4
FG 4	3.5	1/4 Flare	1/4 Flare	3/4	6	.2
FG 6	3.5	3/8 Flare	3/8 Flare	3/4	6-1/4	.3
FH 4	3.5	1/4 Fem. Flare	1/4 Flare	3/4	6	.2
FH 6	3.5	3/8 Fem. Flare	3/8 Flare	3/4	5-3/4	.3
FJ 14	5.8	1/4 Sweat	1/4 Sweat	3/4	5-3/4	.2
FJ 16	5.8	3/8 Sweat	3/8 Sweat	3/4	5-3/4	.2
FJ 18	5.8	1/2 Sweat	1/2 Sweat	3/4	5-3/4	.2
FJ 20	5.8	5/8 Sweat	5/8 Sweat	3/4	5-3/4	.2
FA 4	3.0	1/4 Flare	1/4 Flare	2	3-1/2	.5
FA 6	3.0	3/8 Flare	3/8 Flare	2	3-3/4	.5
FA 8	3.0	1/2 Flare	1/2 Flare	2	4	.6
FC 4	12	1/4 Flare	1/4 Flare	2	5-1/2	.8
FC 6	12	3/8 Flare	3/8 Flare	2	5-3/4	1.0
FC 8	12	1/2 Flare	1/2 Flare	2	6	1.2
FD 4	30	1/4 Flare	1/4 Flare	2	9-1/2	1.3
FD 6	30	3/8 Flare	3/8 Flare	2	9-3/4	1.4
FD 8	30	1/2 Flare	1/2 Flare	2	10	1.5
FD 10	30	5/8 Flare	5/8 Flare	2	10-1/2	1.7
2804-1	24	7/8 Sweat	7/8 Sweat	2	8-3/8	.6
2804-2	24	1-1/8 Sweat	1-1/8 Sweat	2	8-3/8	.6
2804	24	1-3/8 Sweat	1-3/8 Sweat	2	8-3/8	.6
554-3	30	7/8 Sweat	7/8 Sweat	3	9-1/4	1.7
554-2	30	1-1/8 Sweat	1-1/8 Sweat	3	9-1/4	1.7
554-1	30	1-1/4 Sweat	1-1/4 Sweat	3	9-1/4	1.7
554	30	2-1/8 Sweat	2-1/8 Sweat	3	9-1/4	1.7



ACCUMULATORS & ACCUMULATOR-DRIERS



All of the accumulators shown below have 1-5/8" diameter copper shells. Shell dimensions of the accumulator-driers are the same as the accumulators, the only difference being that the accumulator-driers contain our monel wire cloth desiccant bag of 22 grams of silica gel.

Part numbers shown below designate accumulator-driers. *If an accumulator only is desired, this must be specified when ordering by adding an "A" to the part number.

Accumulators and accumulator-driers may be mounted slightly inclined, horizontally or vertically.

*Covered by Patent Nos. 2623607, 2770317 and Patents Pending.

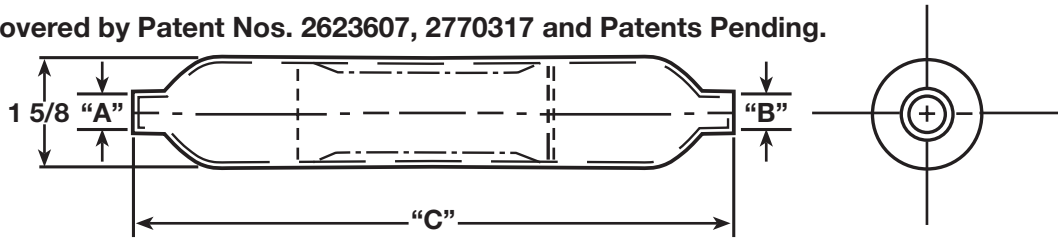

PART NUMBER	"A" I.D.	"B" I.D.	"C" LENGTH	WEIGHT LBS.
620	3/8	3/8	12	.8
621	3/8	1/2	12	.8
622	1/2	1/2	12	.8
623	1/2	5/8	12	.8
624	3/8	3/8	9	.6
625	3/8	1/2	9	.6
626	1/2	1/2	9	.6

MANIFOLDS

Illustrated are Type 1 and Type 2 Manifolds manufactured by Refrigeration Research. They are of copper construction and fit most applications.

TYPE 1

PART NUMBER	A	B	C	D
693	3/8 ID	1/8 ID	1/8 ID	_____
701	3/8 ID	1/4 ID	1/4 ID	_____
707	5/16 ID	3/32 ID	3/16 ID	_____
709	1/2 ID	1/8 ID	1/8 ID	_____
712	1/2 ID	3/4 ID	3/4 ID	_____

TYPE 2

694	3/8 ID	1/8 ID	1/8 ID	1/8 ID
708	5/8 OD	3/16 ID	3/16 ID	3/16 ID
716	7/8 ID	1/2 ID	1/2 ID	1/2 ID
718	1-1/8 ID	5/8 ID	5/8 ID	5/8 ID
727	1/2 OD	5/16 ID	5/16 ID	5/16 ID

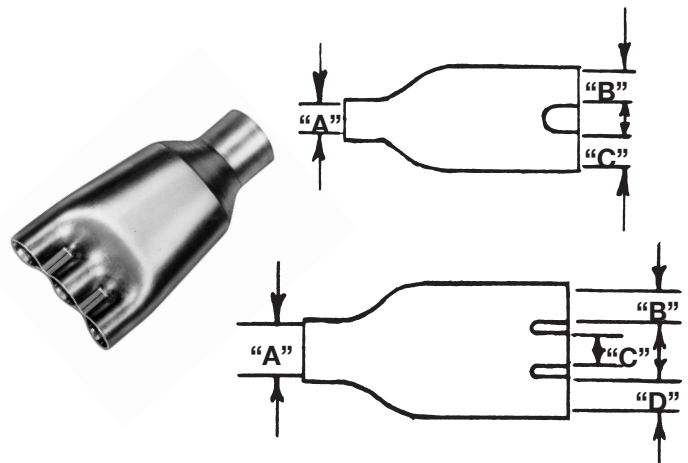

UNIVERSAL DRIERS

Both Universal Driers shown on this page were designed to fulfill a definite need for the Service Engineer. Both save unnecessary and expensive trips because they provide adaptable sweat connections. Both driers are adequate for systems up through one (1) hp. Especially important, all driers are hermetically sealed to stay fresh indefinitely.

EXCLUSIVE

UNIVERSAL BIG R DRIER FOR SYSTEMS THROUGH 1hp.



Catalog NO. 3068

- With Desiccant-Recommended by Desiccant Manufacturers for all Refrigerants and Lubricants.
- BUDGET PRICED and made of ONE PIECE OF COPPER.
- STAYS DRY INDEFINITELY -NO PLASTIC CAPS-Hermetically sealed.
- Cut tube for 3/8" or 1/4" diameter-Form capillary sizes with pliers.
- Contains high capacity molecular sieve desiccant. (For systems up to 1 hp)
- BASKET OUTLET provides large area resulting in smaller pressure drop.

PAT. NO. 3,656,625

DELUXE UNIVERSAL DRIER

Catalog NO. 2933

WITH XH-11 DESICCANT

FOR SYSTEMS THROUGH 1hp.

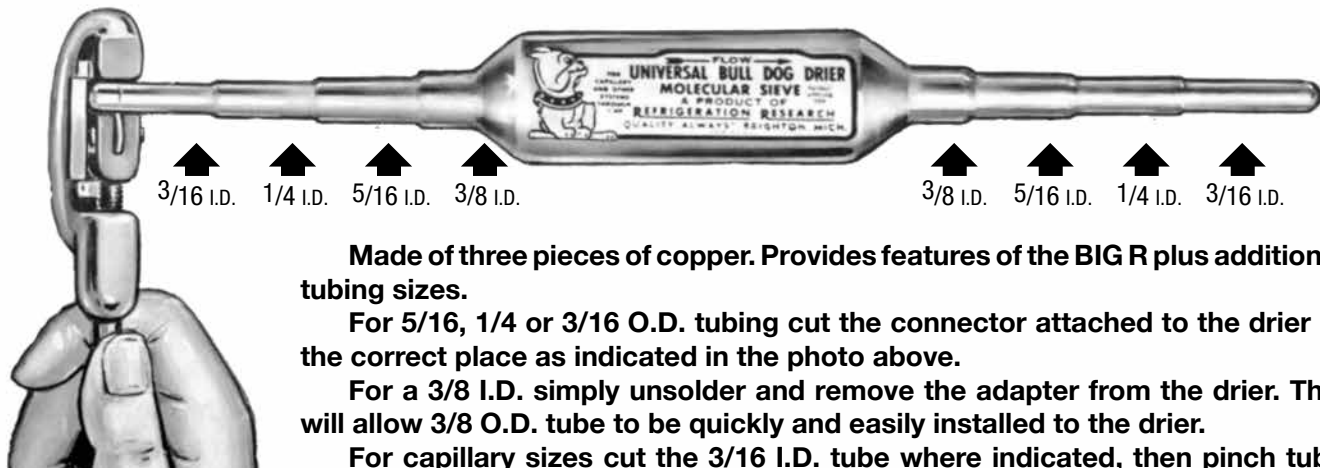

PATENTED

Made of three pieces of copper. Provides features of the BIG R plus additional tubing sizes.

For 5/16, 1/4 or 3/16 O.D. tubing cut the connector attached to the drier at the correct place as indicated in the photo above.

For a 3/8 I.D. simply unsolder and remove the adapter from the drier. This will allow 3/8 O.D. tube to be quickly and easily installed to the drier.

For capillary sizes cut the 3/16 I.D. tube where indicated, then pinch tube down to fit the particular size of capillary.

For systems up through 1 H.P. Drier is 1" O.D. and has overall length of 9 inches.

28



REFRIGERATION RESEARCH, INC.

BULL DOG® CAPILLARY STRAINER-DRIER ASSEMBLIES

18 Applications
FROM
8 Assemblies

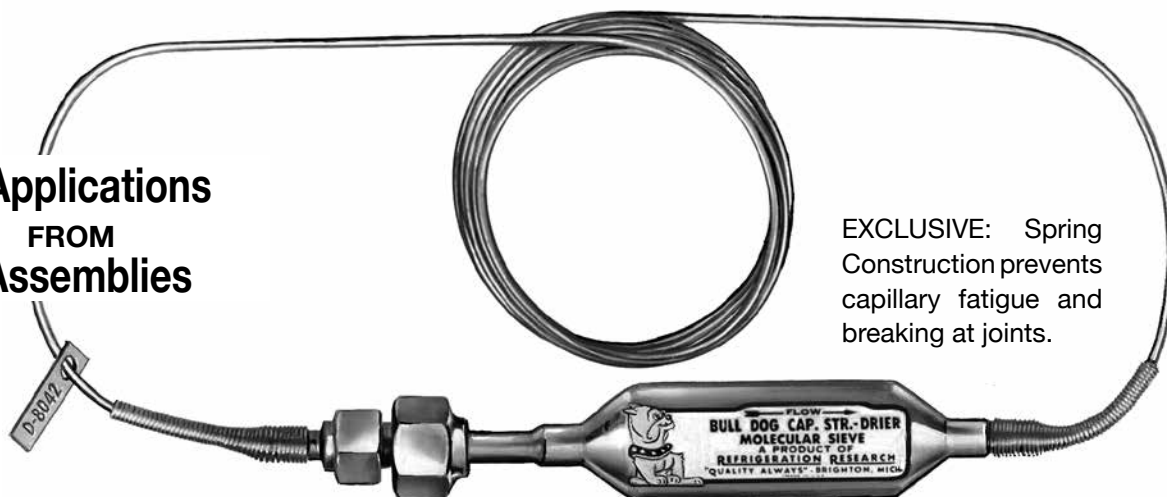

EXCLUSIVE: Spring Construction prevents capillary fatigue and breaking at joints.

These Capillary Strainer-Drier Assemblies containing XH-11 molecular sieves are intended for use on the high side. Adequate desiccant capacity has been provided and a fine mesh outlet basket type strainer protects the capillary tube against plugging.

Compressor Horsepower	Evaporator Temperature		
	Low	Medium	High
1/10 - 1/9 - 1/8	A-16031	B-8031	C-8036
1/6 - 1/5	B-8031	C-8036	D-8042
1/3 - 1/4	C-8036	D-8042	E-10050
1/2	D-8042	E-10050	F-8055
3/4	E-10050	F-8055	G-8070
1	F-8055	G-8070	H-7080

Capillary Strainer-Drier Assemblies are graduated according to the same uniform pattern as the Capillary Strainer-Assemblies on the following page. The numbers differ only in that an extra "0" has been added between the two groups of indicating numbers. Individual metal tag positively identifies bore of capillary.

Drier inlet fitting is 1/4 SAE female and capillary outlet is provided with a 1/4 SAE male fitting. 3/8 SAE fittings available on special order.

JUNIOR BULL DOG® DRIER FOR SYSTEMS THROUGH 3/4 hp. Catalog NO. 2948



This drier contains adequate XH-11 molecular sieve desiccant for units up through 3/4 H.P. and is permanently sealed against moisture for storage. Diameter is one inch and overall length nine inches. A 1/4" diameter copper tube at each end may be cut off, formed or sized as required. Large basket type outlet strainer is provided.



BULL DOG CAPILLARY STRAINER-ASSEMBLIES

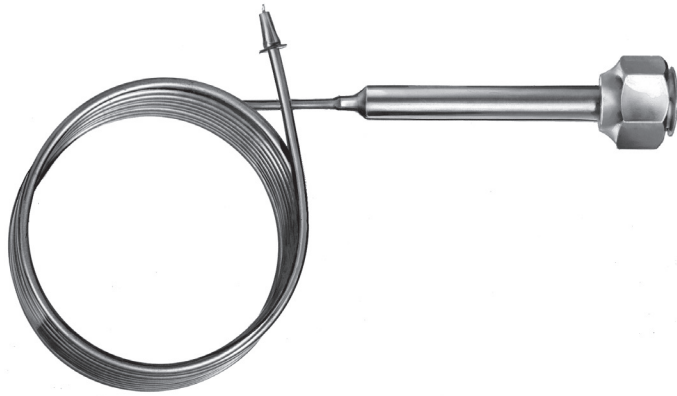

18 Applications FROM 8 Assemblies

Capillary Strainer Assemblies have oversized monel strainer elements of 150 mesh screen for maximum filtration and dirt retention. They have been engineered to provide accurate refrigerant metering for specific applications without field adjustment or cutting.

Assemblies are graduated according to a uniform pattern with "A" having the highest filtration, then "B" "C", etc., through "H", which has the lowest restriction of all. The first number or numbers following the letter indicate the capillary tube length in feet—the last two numbers indicate the inside diameter of the capillary tube in thousandths of an inch.

Inlet fitting is supplied with 3/8" brass flare nut.

Compressor Horsepower	Evaporator Temperature		
	Low	Medium	High
1/10 - 1/9 - 1/8	A-1631	B-831	C-836
1/6 - 1/5	B-831	C-836	D-842
1/3 - 1/4	C-836	D-842	E-1050
1/2	D-842	E-1050	F-855
3/4	E-1050	F-855	G-870
1	F-855	G-870	H-780

CAPILLARY STRAINERS

Illustrated are capillary strainers which are most common in refrigeration use. Construction is copper with monel cloth strainer.

PART NUMBER	OVERALL LENGTH "A"	"B" ID	"C" ID	TUBE O.D.
2076	3	.253 - .257	.127 - .131	3/8
2611	2-1/4	.190 - .194	.083 - .087	1/4
2612	2-1/4	.190 - .194	.087 - .091	1/4
2613	2-1/8	.253 - .257	.087 - .091	5/16
2632	2-1/8	.253 - .257	.101 - .105	5/16

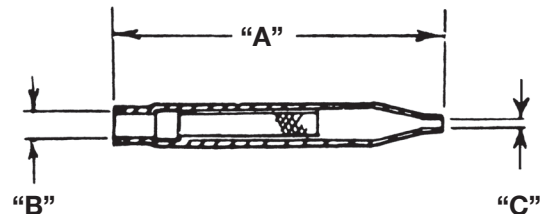

CAPILLARY TUBING

Capillary tubing listed below is of uniform plug drawn quality. Shipped in coils of approximately 100 ft.

CATALOG NUMBER	I.D.	O.D.	APPROX. WT. PER 100' COIL
03181	.031	.081	1.7
03687	.036	.087	1.9
04293	.042	.093	2.0
04999	.049	.099	2.2
04925	.049	.125	3.9
05525	.055	.125	3.8

CATALOG NUMBER	I.D.	O.D.	APPROX. WT. PER 100' COIL
06025	.060	.125	3.6
06425	.064	.125	3.5
07025	.070	.125	3.3
08040	.080	.140	4.0
08545	.085	.145	4.2
09050	.090	.150	4.4

Tolerance = +/- .002 on O.D.; +/- .001 on I.D.



STRAINER ELEMENTS

The following are a few of the more popular special strainer elements supplied to O.E.M. accounts in quantities. These strainer elements may be pressed into tubes or can be furnished in cartridges as shown below. **PRICES AVAILABLE ONLY ON SPECIAL QUOTATIONS AND IN QUANTITIES.**

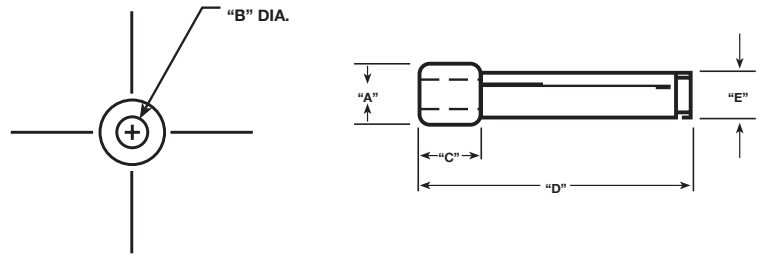

STR. NO.	TO PRESS INTO A TUBE OF	A	B	C	D	E	APPROX. AREA	BINDING
161	3/8 x .032	.311 - .313	.121 - .123	1/4	1-1/4	1/4	.7	Machined Brass
2586	3/4 x .035	.685 - .688	.430	1/2	3-5/8	9/16	6.0	Stamped
178	1 x .035	.936 - .939	.687	1/4	1-9/16	3/4	3.0	Stamped
2487	1 x .035	.936 - .939	.687	1/4	2-1/2	3/4	6.0	Stamped
179	1-1/4 x .035	1.187 - 1.189	.812	5/16	3-5/8	7/8	9.0	Stamped
2582	1-1/4 x .035	1.187 - 1.189	.812	5/16	4-5/8	7/8	12.0	Stamped
2587	2 x .035	1.934 - 1.936	1.437	5/16	2-5/8	1.50	12.0	Stamped
2588	2 x .035	1.934 - 1.936	1.437	5/16	6-1/2	1.50	30.0	Stamped

CARTRIDGE OR PENCIL TYPE STRAINERS

These strainers, made from copper tubing, contain strainer elements shown above. Several hundred special assemblies may be made from the combinations below and general types only are illustrated. **ADDITIONAL CUSTOMER INFORMATION IS REQUIRED TO DEFINE A PARTICULAR STRAINER. QUOTATIONS ARE MADE ONLY UPON SPECIAL APPLICATION AND IN PRODUCTION QUANTITIES.**

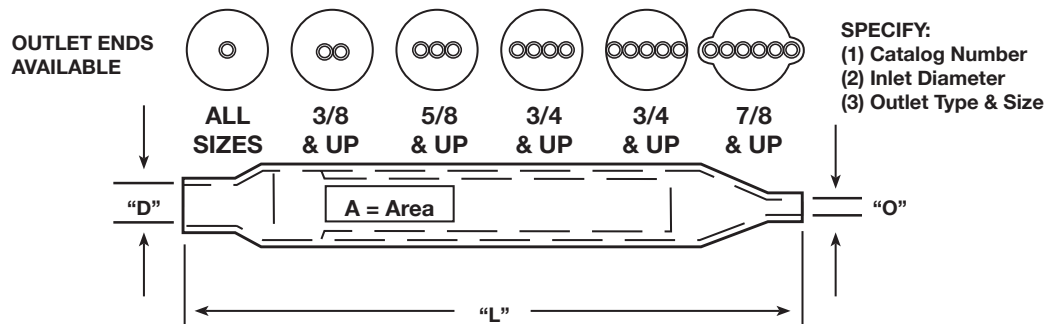

Clearance is allowed to provide proper fit for nominal capillary or tube sizes.

TYPE	CARTRIDGE OD & WALL	CAT. LGTH. "L"	STRAINER ELEMENT NO.	STRAINER ELEMENT AREA	Screen Mesh	BINDING	INLET ID's † AVAILABLE "D"	OUTLET ID's † "O"
37B	3/8 x .032	3	161	.7	150	Machined Brass	3/16, 1/4, 5/16 & 3/8	
75S	3/4 x .035	3-5/8	4764	3	100	Stamped	1/4, 3/8, 1/2, 5/8, & 3/4	standard
75SL	3/4 x .035	5-7/8	2586	6	100	Stamped	1/4, 3/8, 1/2, 5/8, & 3/4	cap
100S	1 x .035	3-5/16	178	3	100	Stamped	1/4, 3/8, 1/2, 5/8, & 3/4	
100SL	1 x .035	5-1/4	2487	6	100	Stamped	1/4, 3/8, 1/2, 5/8, & 3/4	
125S	1-1/4 x .035	5-5/16	179	6	100	Stamped	3/8, 1/2, & 5/8	
125L	1-1/4 x .035	6-1/2	177	9	100	Stamped	3/8, 1/2 & 5/8	
200S	2 x .035	6-1/2	2587	12	100	Stamped	3/8, 1/2 & 5/8	
200SL	2 x .035	10	2588	30	100	Stamped	3/8, 1/2 & 5/8	

† NOMINAL



File No. SA 2401 Vol. 2

OUTLETS AVAILABLE FOR STANDARD CAPILLARY.





REFRIGERATION **RESEARCH** INC.

525 North Fifth Street • P.O. Box 869
Brighton, Michigan 48116

Phone: (810) 227-1151

FAX: (810) 227-3700

WEBSITE: www.refresearch.com





PRODUCTS:

- **Accumulators**
- **Accumulator Driers**
- **Capillary Assemblies**
- **Chillers**
- **Condensers**
- **Driers**
- **Fusible Plugs**
- **Heat Exchangers**
- **Manifolds**
- **Mufflers**
- **Oil Reservoirs**
- **Oil Separators**
- **Receivers**
- **Sight Glasses**
- **Strainers**
- **Suction Accumulators**



**Refrigeration
Research, Inc.**

Refrigeration Research, Inc.
525 North Fifth St.
Brighton, MI 48116
810-227-1151
www.refresearch.com